

Three Phase Rectifier Bridge in ISOPLUS i4-PAC™

$$I_{dAV} = 28 \text{ A}$$

$$V_{RRM} = 1200/1600 \text{ V}$$

V_{RSM} V	V_{RRM} V	Type
1300	1200	FUO 22-12N
1700	1600	FUO 22-16N

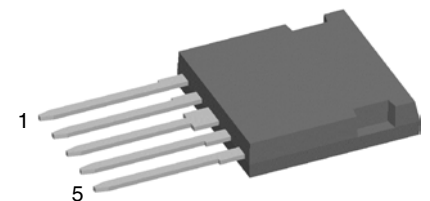
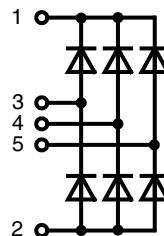

Symbol	Conditions	Maximum Ratings	
I_{dAV} ①	$T_C = 90^\circ\text{C}$, rect. 120°	28	A
I_{dAVM} ①	module, rect. 120°	35	A
I_{FSM}	$T_{VJ} = 45^\circ\text{C}$; $t = 10 \text{ ms}$ (50 Hz)	100	A
	$V_R = 0$; $t = 8.3 \text{ ms}$ (60 Hz)	106	A
	$T_{VJ} = T_{VJM}$; $t = 10 \text{ ms}$ (50 Hz)	85	A
	$V_R = 0$; $t = 8.3 \text{ ms}$ (60 Hz)	90	A
I^2t	$T_{VJ} = 45^\circ\text{C}$; $t = 10 \text{ ms}$ (50 Hz)	50	A ² s
	$V_R = 0$; $t = 8.3 \text{ ms}$ (60 Hz)	47	A ² s
	$T_{VJ} = T_{VJM}$; $t = 10 \text{ ms}$ (50 Hz)	36	A ² s
	$V_R = 0$; $t = 8.3 \text{ ms}$ (60 Hz)	33	A ² s
T_{VJ}		-55...+150	°C
T_{VJM}		150	°C
T_{stg}		-55...+125	°C
V_{ISOL}	50/60 Hz, RMS $t = 1 \text{ min}$	2500	V~
	$I_{ISOL} \leq 1 \text{ mA}$ $t = 1 \text{ s}$	3000	V~
F_C	mounting force with clip	20 ... 120	N
P_{tot}	$T_{VJ} = 25^\circ\text{C}$	30	W
Weight	Typ.	9	g

Features

- rectifier diodes for line frequency
- ISOPLUS i4-PAC™ package
 - isolated back surface
 - UL registered E 72873
 - low coupling capacity between pins and heatsink
 - enlarged creepage towards heatsink
- application friendly pinout
- high reliability
- industry standard outline

Applications

- three phase mains rectifiers

Symbol	Conditions	Characteristic Values	
I_R	$V_R = V_{RRM}$ $T_{VJ} = 25^\circ\text{C}$ $T_{VJ} = T_{VJM}$	5	μA
		typ. 0.2	mA
V_F	$I_F = 15 \text{ A}$ $T_{VJ} = 25^\circ\text{C}$	1.3	V
V_{T0}	for power-loss calculations only	0.8	V
r_t		30	$\text{m}\Omega$
R_{thJC}	(per diode)	4	K/W
R_{thCH}		typ. 1	K/W
d_S, d_A	pin - pin	1.7	mm
d_S, d_A	pin - backside metal	5.5	mm
a	Max. allowable acceleration	50	m/s^2
C_P	coupling capacity between shorted pins and mounting tab in the case	typ. 40	pF

Data according to IEC 60747 and refer to a single diode unless otherwise stated.
① for resistive load at bridge output

IXYS reserves the right to change limits, test conditions and dimensions.

© 2007 IXYS All rights reserved

Dimensions in mm (1 mm = 0.0394")

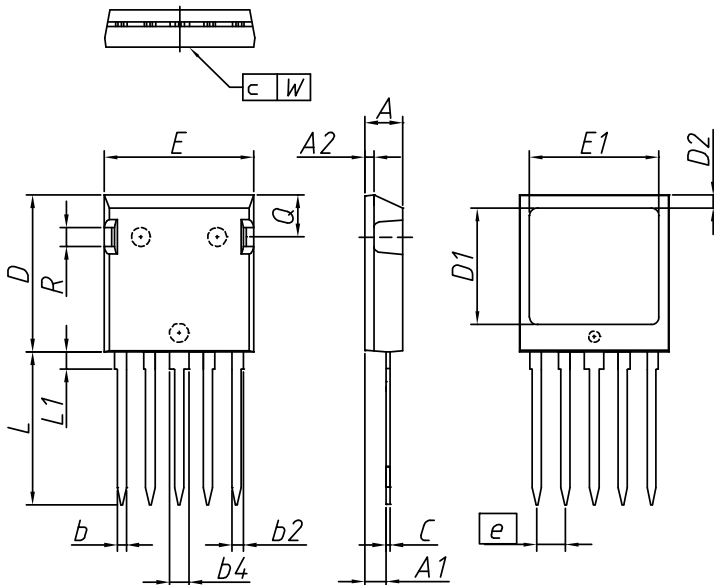

DIM.	MILLIMETER		INCHES	
	MIN	MAX	MIN	MAX
A	4,83	5,21	0,190	0,205
A1	2,59	3,00	0,102	0,118
A2	1,17	2,16	0,046	0,085
b	1,14	1,40	0,045	0,055
b1	1,47	1,73	0,058	0,068
b2	2,54	2,79	0,100	0,110
C	0,51	0,74	0,020	0,029
D	20,80	21,34	0,819	0,840
D1	14,99	15,75	0,590	0,620
D2	1,65	2,03	0,065	0,080
E	19,56	20,29	0,770	0,799
E1	16,76	17,53	0,660	0,690
e	3,81	BSC	0,15	BSC
L	19,81	21,34	0,780	0,840
L1	2,11	2,59	0,083	0,102
Q	5,33	6,20	0,210	0,244
R	2,54	4,57	0,100	0,180
W	-	0,10	-	0,004

Die konvexe Form des Substrates ist typ. < 0,05 mm über der Kunststoffoberfläche der Bauteilunterseite

The convex bow of substrate is typ. < 0.05 mm over plastic surface level of device bottom side

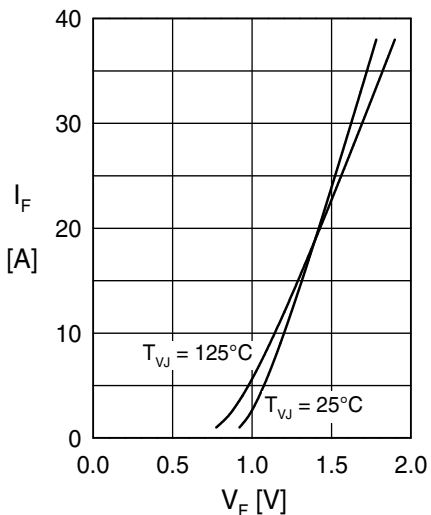

Fig. 1 Forward current vs. voltage drop per diode

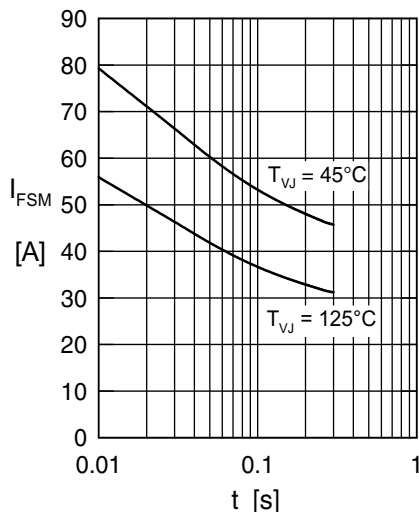

Fig. 2 Surge overload current per diode I_{FSM} : crest value. t: duration

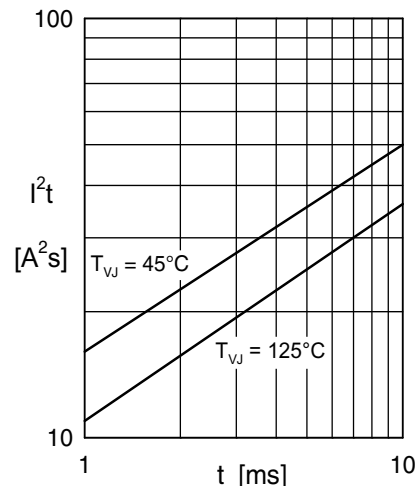

Fig. 2 I^2t versus time (1-10 ms) per diode

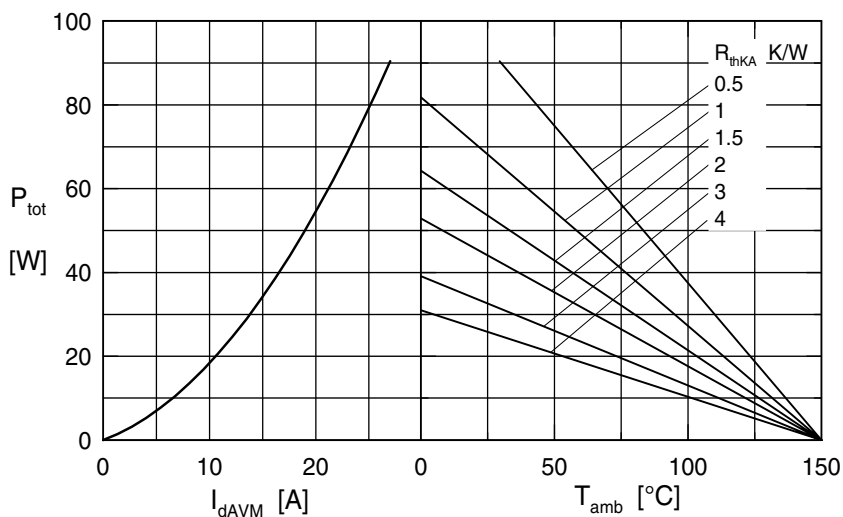

Fig. 3 Power dissipation vs. direct output current and ambient temperature

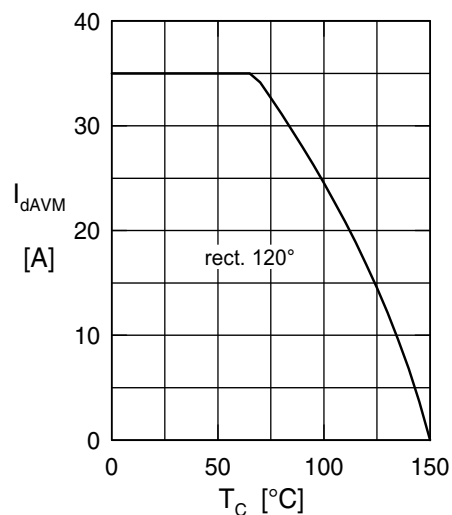

Fig. 4 Maximum forward current at case temperature T_C

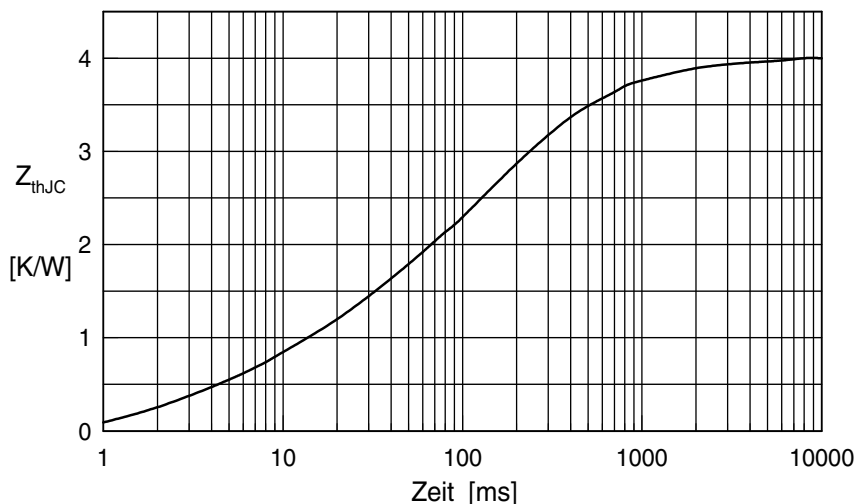

Fig. 5 Transient thermal impedance junction to case per diode

Constants for Z_{thJC} calculation:

i	R_{thi} (K/W)	t_i (s)
1	0.0007604	0.00001
2	0.03587	0.00005
3	0.2439	0.011
4	0.7173	0.067
5	0.5021	0.028