

# TPA152 75-mW STEREO AUDIO POWER AMPLIFIER

SLOS210A – JUNE 1998 – REVISED MARCH 2000

- High-Fidelity Line-Out/HP Driver
- 75-mW Stereo Output
- PC Power Supply Compatible
- Pop Reduction Circuitry
- Internal Mid-Rail Generation
- Thermal and Short-Circuit Protection
- Surface-Mount Packaging
- Pin Compatible With TPA302

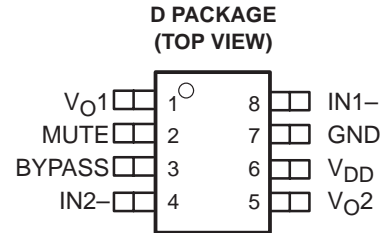

## description

The TPA152 is a stereo audio power amplifier capable of less than 0.1% THD+N at 1 kHz when delivering 75 mW per channel into a 32- $\Omega$  load. THD+N is less than 0.2% across the audio band of 20 to 20 kHz. For 10 k $\Omega$  loads, the THD+N performance is better than 0.005% at 1 kHz, and less than 0.01% across the audio band of 20 to 20 kHz.

The TPA152 is ideal for use as an output buffer for the audio CODEC in PC systems. It is also excellent for use where a high-performance head phone/line-out amplifier is needed. Depop circuitry is integrated to reduce transients during power up, power down, and mute mode.

Amplifier gain is externally configured by means of two resistors per input channel and does not require external compensation for settings of 1 to 10. The TPA152 is packaged in the 8-pin SOIC (D) package that reduces board space and facilitates automated assembly.

## typical application circuit

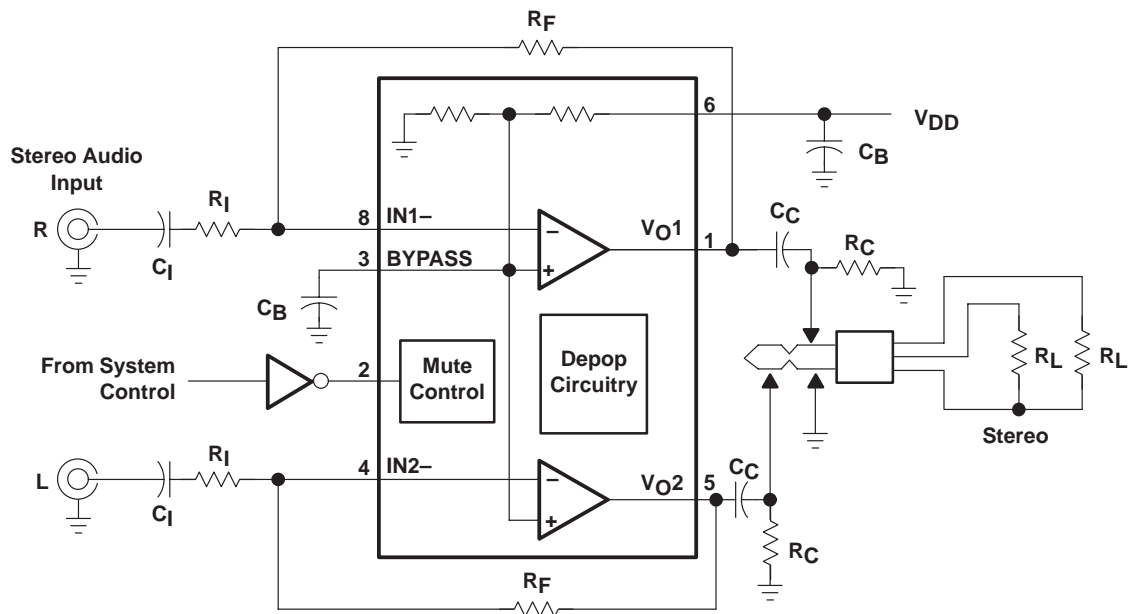

PRODUCTION DATA information is current as of publication date. Products conform to specifications per the terms of Texas Instruments standard warranty. Production processing does not necessarily include testing of all parameters.

 **TEXAS  
INSTRUMENTS**

POST OFFICE BOX 655303 • DALLAS, TEXAS 75265

Copyright © 2000, Texas Instruments Incorporated

# TPA152

## 75-mW STEREO AUDIO POWER AMPLIFIER

SLOS210A – JUNE 1998 – REVISED MARCH 2000

### AVAILABLE OPTIONS

$T_A$	PACKAGED DEVICE
	SMALL OUTLINE
–40°C to 85°C	TPA152D†

† The D packages are available taped and reeled. To order a taped and reeled part, add the suffix R (e.g., TPA152DR)

### Terminal Functions

TERMINAL NAME	NO.	I/O	DESCRIPTION
BYPASS	3		BYPASS is the tap to the voltage divider for internal mid-supply bias. This terminal should be connected to a 0.1- $\mu$ F to 1- $\mu$ F capacitor.
GND	7		GND is the ground connection.
IN1–	8	I	IN1– is the inverting input for channel 1.
IN2–	4	I	IN2– is the inverting input for channel 2.
MUTE	2	I	A logic high puts the device into MUTE mode.
VDD	6	I	VDD is the supply voltage terminal.
VO1	1	O	VO1 is the audio output for channel 1.
VO2	5	O	VO2 is the audio output for channel 1.



POST OFFICE BOX 655303 • DALLAS, TEXAS 75265

# TPA152

## 75-mW STEREO AUDIO POWER AMPLIFIER

SLOS210A – JUNE 1998 – REVISED MARCH 2000

### absolute maximum ratings over operating free-air temperature range (unless otherwise noted)†

Supply voltage, $V_{DD}$	6 V
Input voltage, $V_I$	–0.3 V to $V_{DD} + 0.3$ V
Continuous total power dissipation	internally limited (See Dissipation Rating Table)
Operating junction temperature range, $T_J$	–40°C to 150°C
Operating case temperature range, $T_C$	–40°C to 125°C
Storage temperature range, $T_{stg}$	–65°C to 150°C
Lead temperature 1,6 mm (1/16 inch) from case for 10 seconds	260°C

† Stresses beyond those listed under “absolute maximum ratings” may cause permanent damage to the device. These are stress ratings only, and functional operation of the device at these or any other conditions beyond those indicated under “recommended operating conditions” is not implied. Exposure to absolute-maximum-rated conditions for extended periods may affect device reliability.

**DISSIPATION RATING TABLE**

PACKAGE	$T_A \leq 25^\circ\text{C}$	DERATING FACTOR	$T_A = 70^\circ\text{C}$	$T_A = 85^\circ\text{C}$
D	724 mW	5.8 mW/°C	464 mW	376 mW

### recommended operating conditions

	MIN	MAX	UNIT
Supply voltage, $V_{DD}$	4.5	5.5	V
Operating free-air temperature, $T_A$	–40	85	°C

### dc electrical characteristics at $T_A = 25^\circ\text{C}$ , $V_{DD} = 5$ V

PARAMETER	TEST CONDITIONS	MIN	TYP	MAX	UNIT
$V_{OO}$ Output offset voltage				10	mV
Supply ripple rejection ratio	$V_{DD} = 4.9$ V to 5.1 V		81		dB
$I_{DD}$ Supply current	See Figure 13		5.5	14	mA
$I_{DD}(\text{MUTE})$ Supply current in MUTE			5.5	14	mA
$Z_I$ Input impedance			>1		M $\Omega$

### ac operating characteristics $V_{DD} = 5$ V, $T_A = 25^\circ\text{C}$ , $R_L = 32 \Omega$ (unless otherwise noted)

PARAMETER	TEST CONDITIONS	MIN	TYP	MAX	UNIT
$P_O$ Output power (each channel)	THD $\leq 0.03\%$ , Gain = 1, See Figure 1		75†		mW
THD+N Total harmonic distortion plus noise	$P_O = 75$ mW, 20 Hz–20 kHz, Gain = 1, See Figure 2		0.2%		
$B_{OM}$ Maximum output power bandwidth	$A_V = 5$ , THD $< 0.6\%$ , See Figure 2		>20		kHz
Phase margin	Open loop, See Figure 16		80°		
Supply ripple rejection ratio	1 kHz, $C_B = 1 \mu\text{F}$ , See Figure 12		65		dB
Mute attenuation	See Figure 15		110		dB
Ch/Ch output separation	See Figure 13		102		dB
Signal-to-Noise ratio	$V_O = 1$ V(rms), Gain = 1 See Figure 11		104		dB
$V_N$ Noise output voltage	See Figure 10		6		$\mu\text{V}(\text{rms})$

† Measured at 1 kHz.

- NOTES: 1. The dc output voltage is approximately  $V_{DD}/2$ .  
 2. Output power is measured at the output pins of the IC at 1 kHz.



# TPA152

## 75-mW STEREO AUDIO POWER AMPLIFIER

SLOS210A – JUNE 1998 – REVISED MARCH 2000

ac operating characteristics  $V_{DD} = 5\text{ V}$ ,  $T_A = 25^\circ\text{C}$ ,  $R_L = 10\text{ k}\Omega$

PARAMETER		TEST CONDITIONS	MIN	TYP	MAX	UNIT
THD+N	Total harmonic distortion plus noise	$V_I = 1\text{ V}_{(rms)}$ , See Figure 6	20 Hz–20 kHz, Gain = 1,		0.005%	
		$V_O(PP) = 4\text{ V}$ , See Figure 8	20 Hz–20 kHz, Gain = 1,		0.005%	
BOM	Maximum output power bandwidth	G = 5,	THD <0.02%, See Figure 6		>20	kHz
	Phase margin	Open loop,	See Figure 16		80°	
k <sub>SVR</sub>	Supply voltage rejection ratio	1 kHz,	$C_B = 1\text{ }\mu\text{F}$ ,	See Figure 12		dB
	Mute attenuation	See Figure 15			110	
	Ch/Ch output separation	See Figure 13			102	dB
	Signal-to-Noise ratio	$V_O = 1\text{ V}_{(rms)}$ ,	Gain = 1,	See Figure 11		dB
$V_n$	Noise output voltage	See Figure 10			6	$\mu\text{V}_{(rms)}$

† Measured at 1 kHz.

### TYPICAL CHARACTERISTICS

#### Table of Graphs

		FIGURE	
THD+N	Total harmonic distortion plus noise	vs Output power	1, 4
THD+N	Total harmonic distortion plus noise	vs Frequency	2, 3, 6, 8, 9
THD+N	Total harmonic distortion plus noise	vs Output voltage	5, 7
$V_n$	Output noise voltage	vs Frequency	10
SNR	Signal-to-noise ratio	vs Gain	11
	Supply ripple rejection ratio	vs Frequency	12
	Crosstalk	vs Frequency	13, 14
	Mute Attenuation	vs Frequency	15
	Open-loop gain and phase	vs Frequency	16, 17
	Closed-loop gain and phase	vs Frequency	18
$I_{DD}$	Supply current	vs Supply voltage	19
$P_O$	Output power	vs Load resistance	20
$P_D$	Power dissipation	vs Output power	21



TYPICAL CHARACTERISTICS

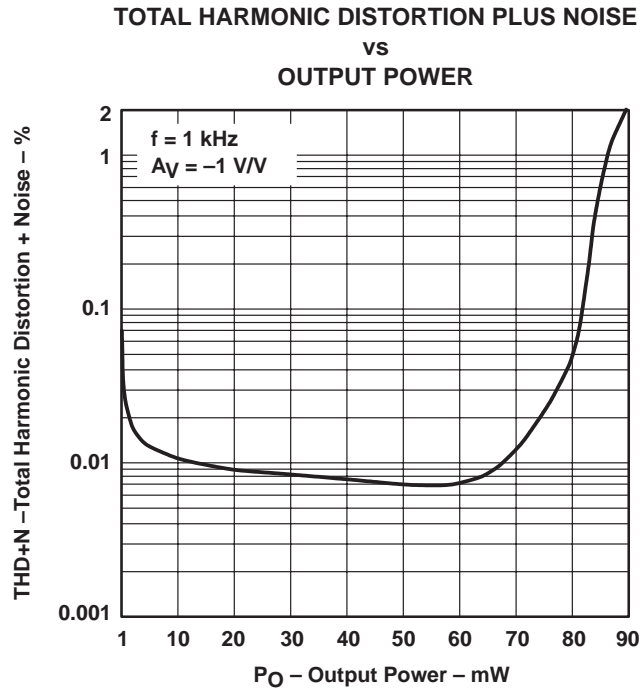

Figure 1

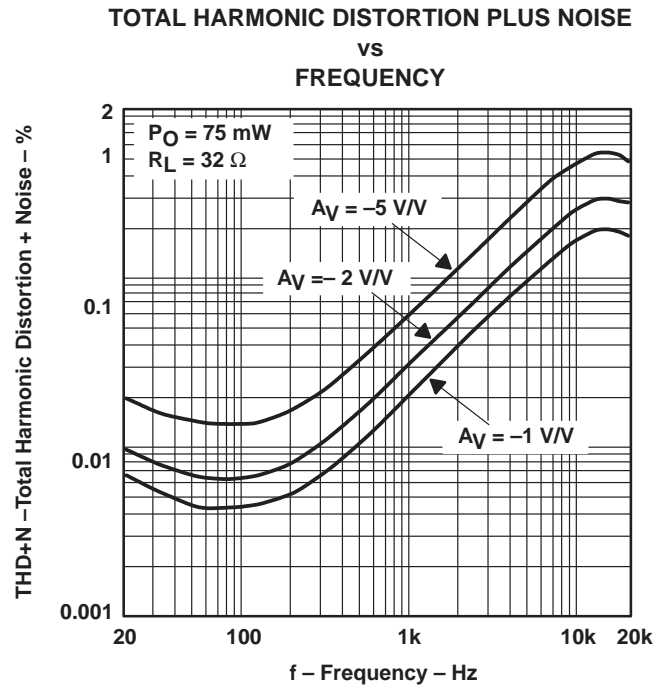

Figure 2

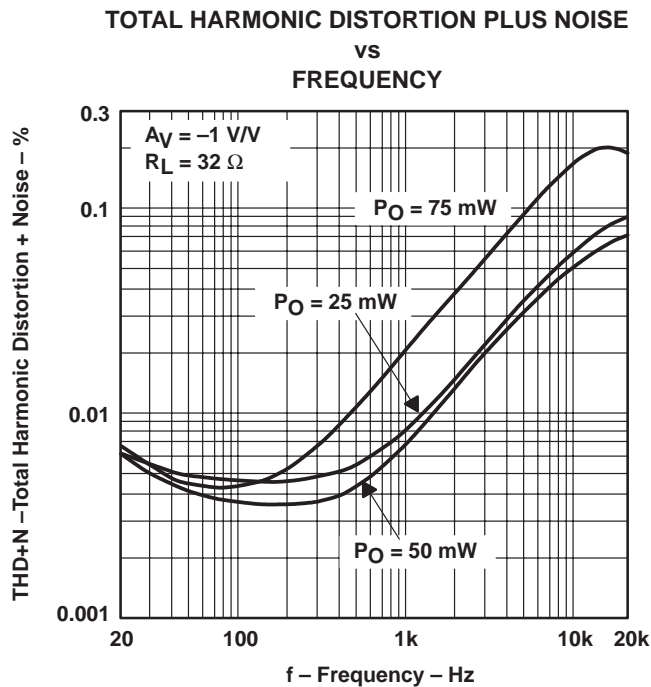

Figure 3

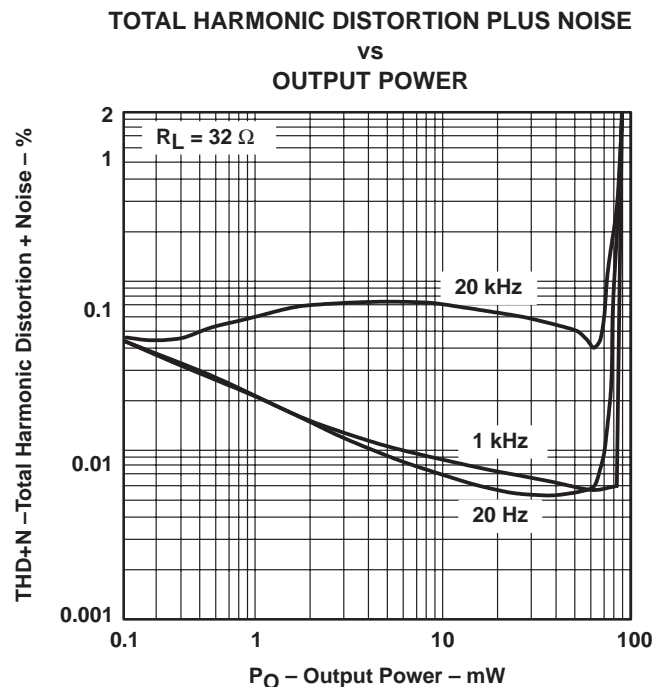

Figure 4

# TPA152 75-mW STEREO AUDIO POWER AMPLIFIER

SLOS210A – JUNE 1998 – REVISED MARCH 2000

## TYPICAL CHARACTERISTICS

TOTAL HARMONIC DISTORTION PLUS NOISE  
vs  
OUTPUT VOLTAGE

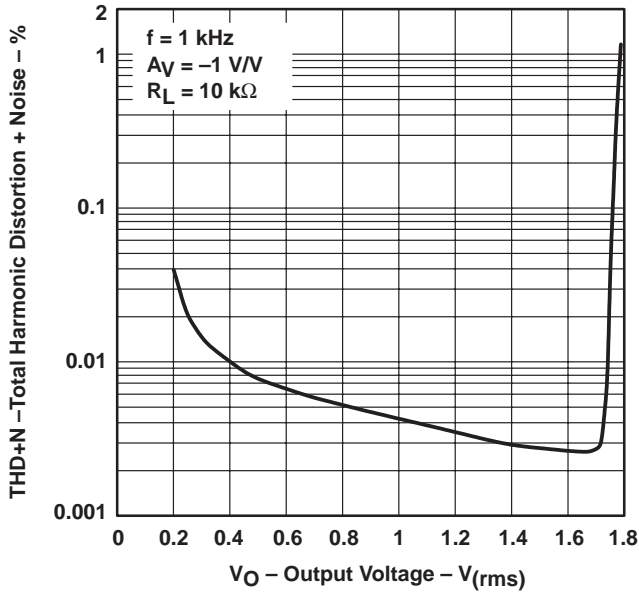

Figure 5

TOTAL HARMONIC DISTORTION PLUS NOISE  
vs  
FREQUENCY

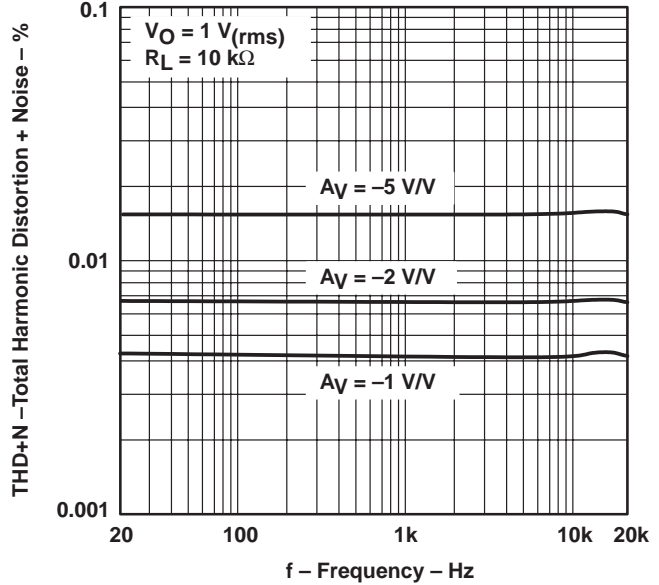

Figure 6

TOTAL HARMONIC DISTORTION PLUS NOISE  
vs  
OUTPUT VOLTAGE

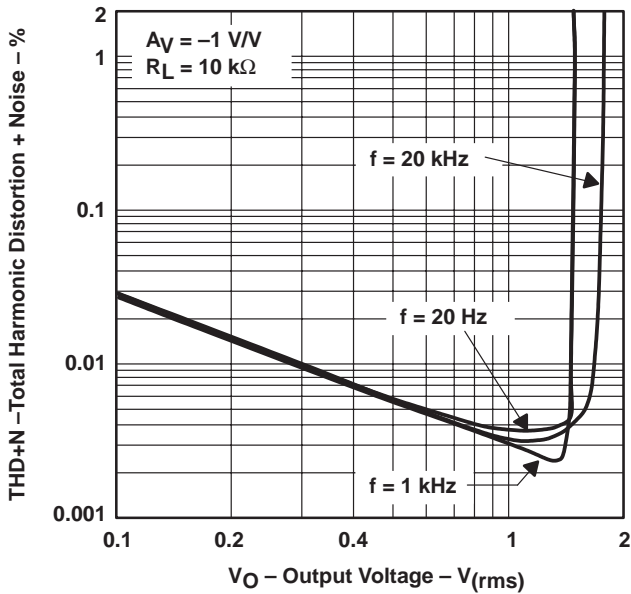

Figure 7

TOTAL HARMONIC DISTORTION PLUS NOISE  
vs  
FREQUENCY

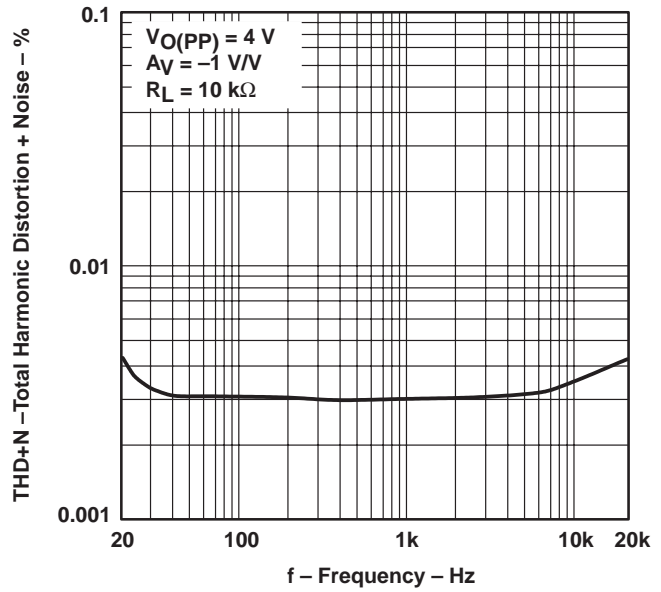

Figure 8



TYPICAL CHARACTERISTICS

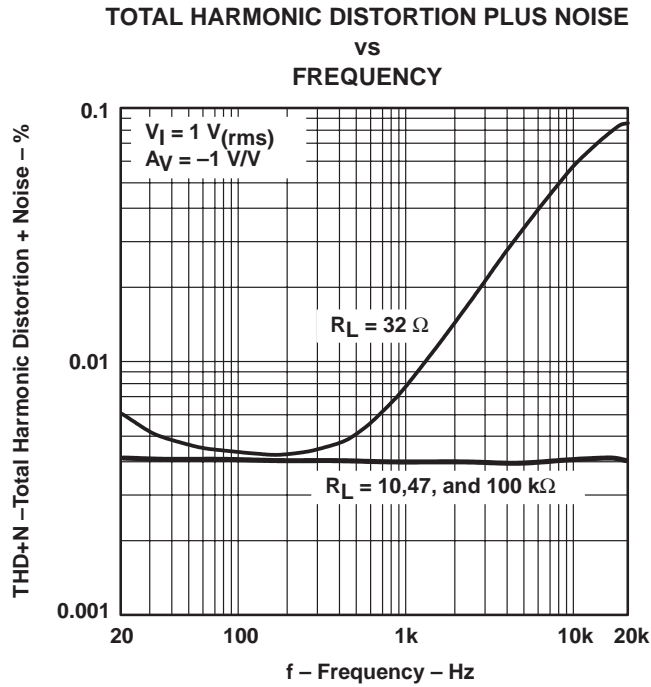

Figure 9

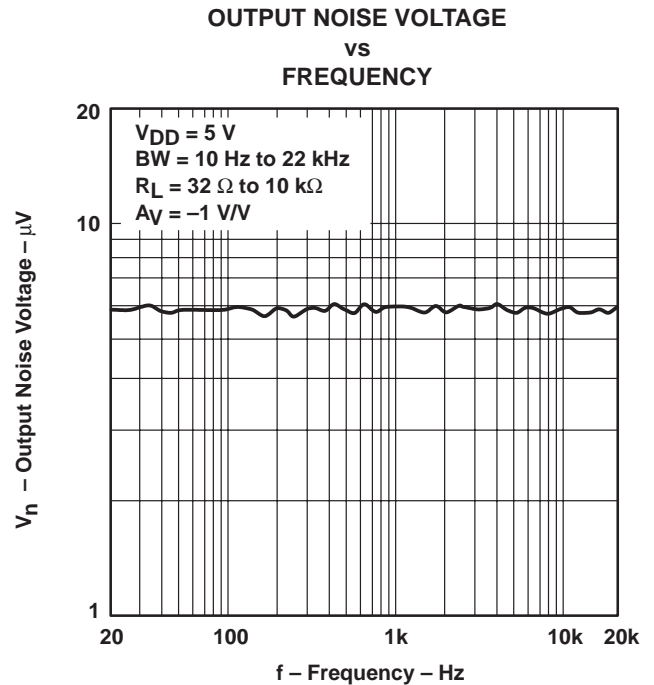

Figure 10

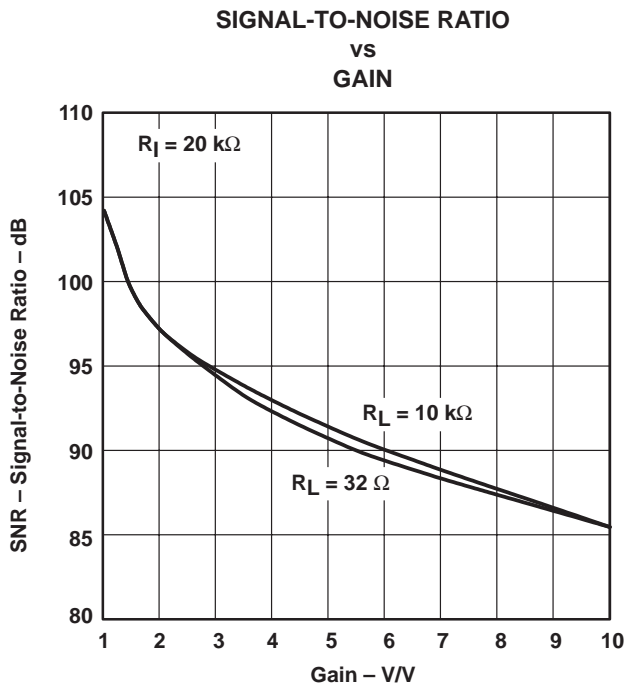

Figure 11

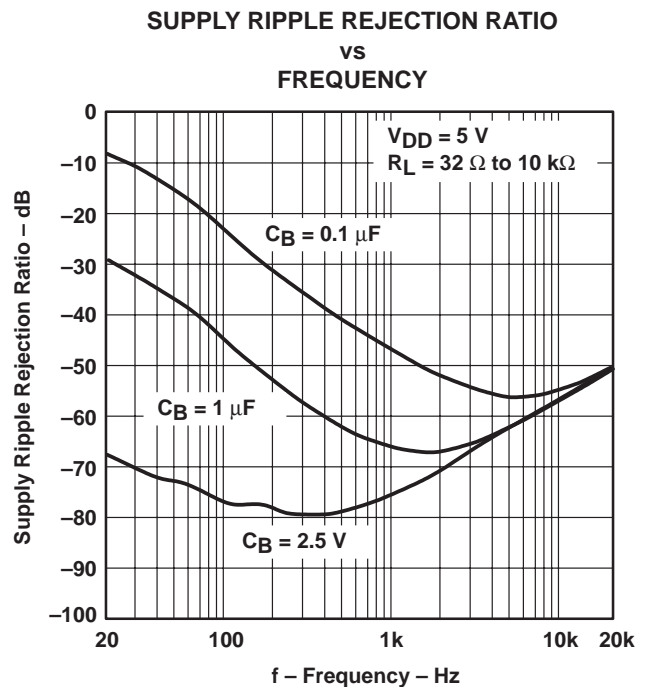

Figure 12

# TPA152 75-mW STEREO AUDIO POWER AMPLIFIER

SLOS210A – JUNE 1998 – REVISED MARCH 2000

## TYPICAL CHARACTERISTICS

**CROSSTALK  
vs  
FREQUENCY**

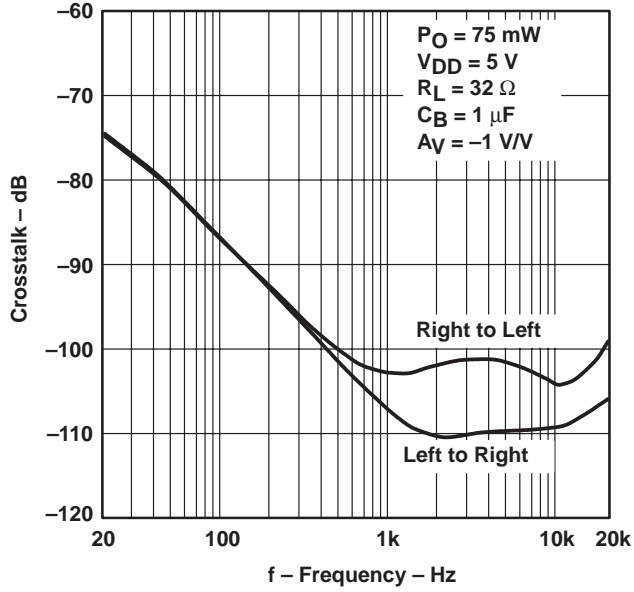

Figure 13

**CROSSTALK  
vs  
FREQUENCY**

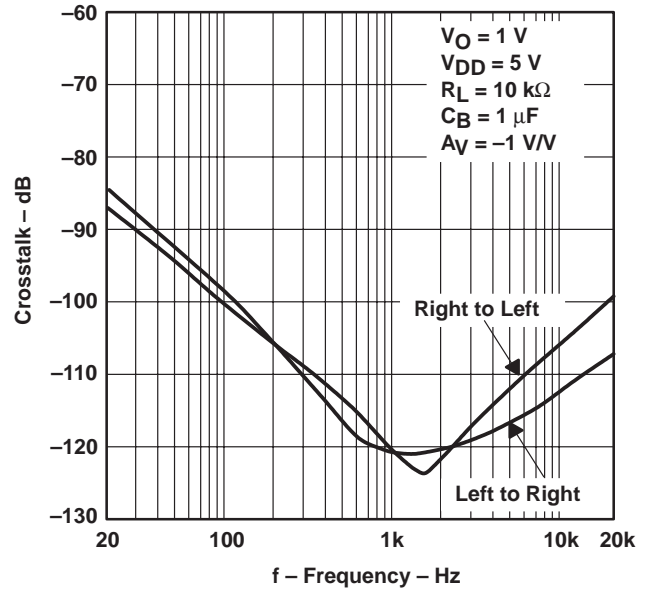

Figure 14

**MUTE ATTENUATION  
vs  
FREQUENCY**

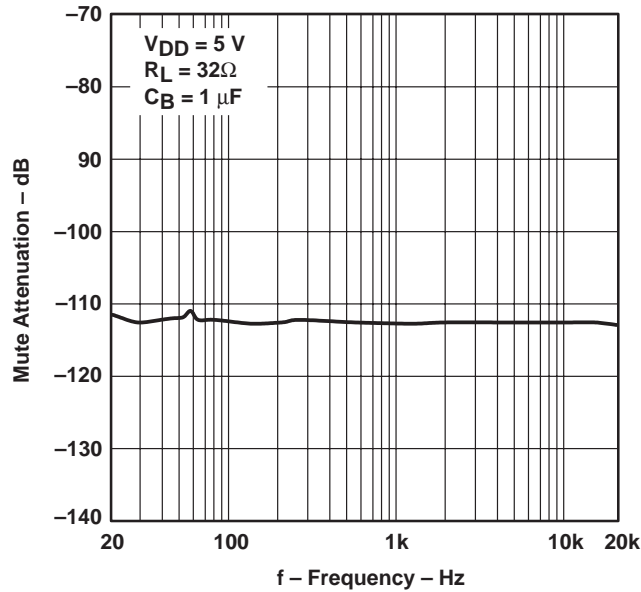

Figure 15



TYPICAL CHARACTERISTICS

OPEN-LOOP GAIN AND PHASE  
vs  
FREQUENCY

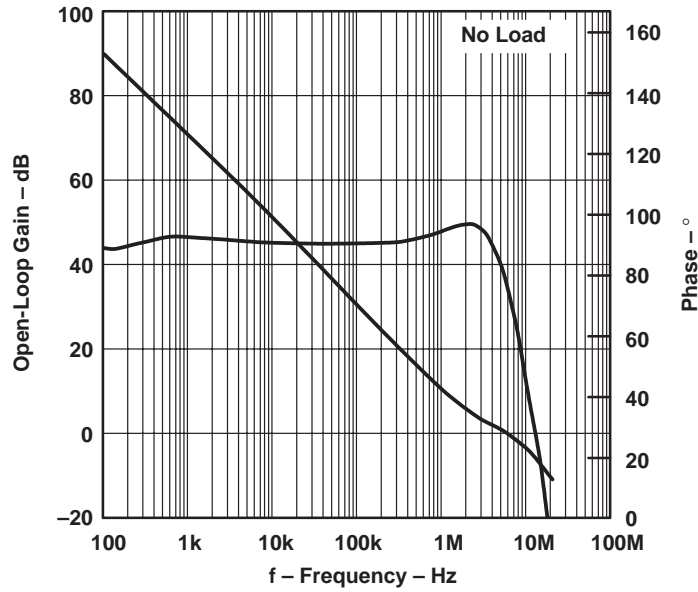

Figure 16

CLOSED-LOOP GAIN AND PHASE  
vs  
FREQUENCY

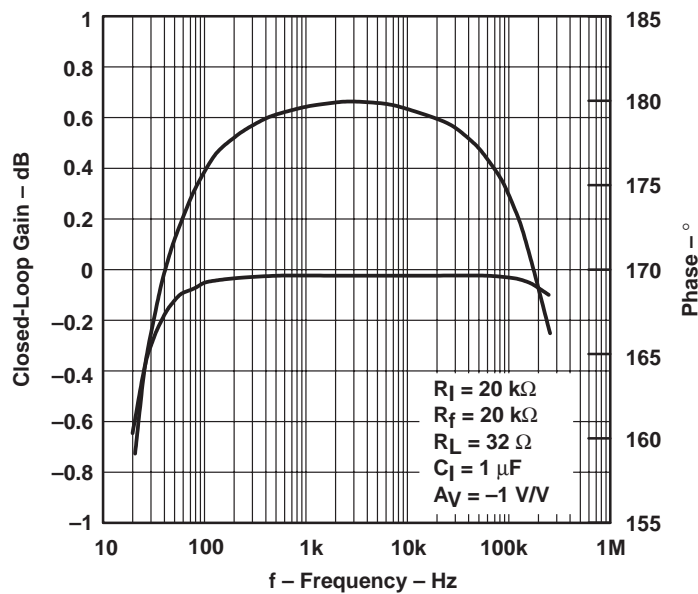

Figure 17

TYPICAL CHARACTERISTICS

CLOSED-LOOP GAIN AND PHASE  
VS  
FREQUENCY

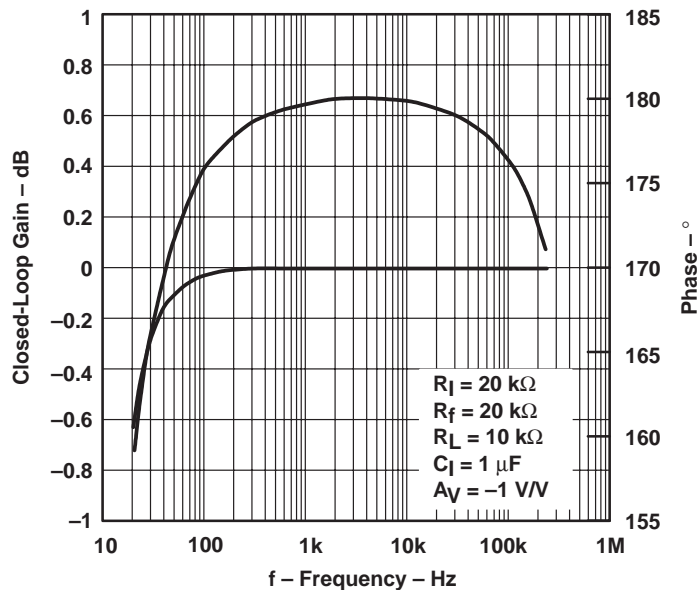

Figure 18

SUPPLY CURRENT  
VS  
SUPPLY VOLTAGE

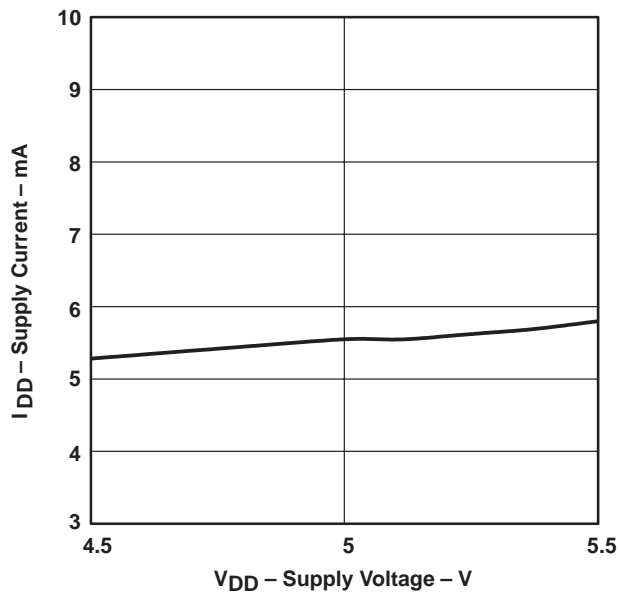

Figure 19

OUTPUT POWER  
VS  
LOAD RESISTANCE

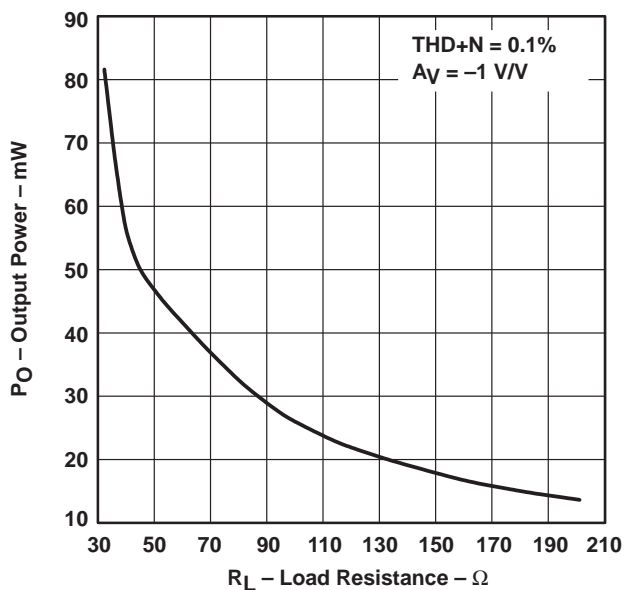
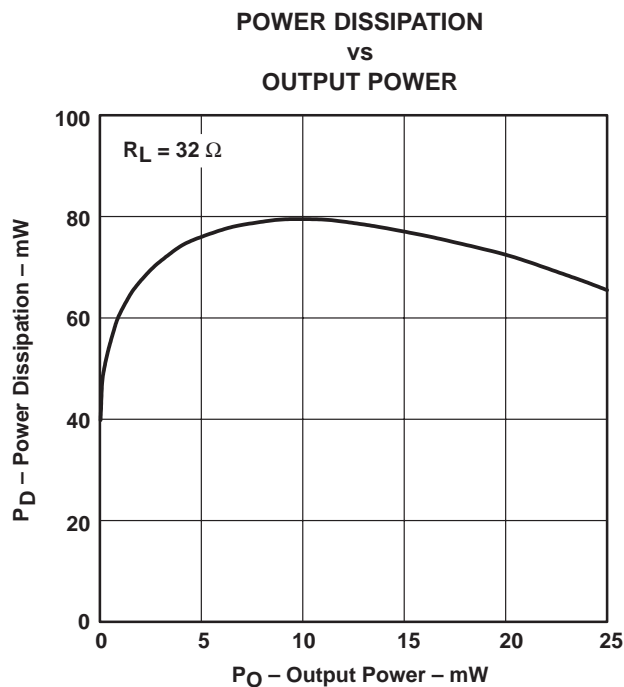

Figure 20

TYPICAL CHARACTERISTICS



APPLICATION INFORMATION

selection of components

Figure 22 is a schematic diagram of a typical application circuit.

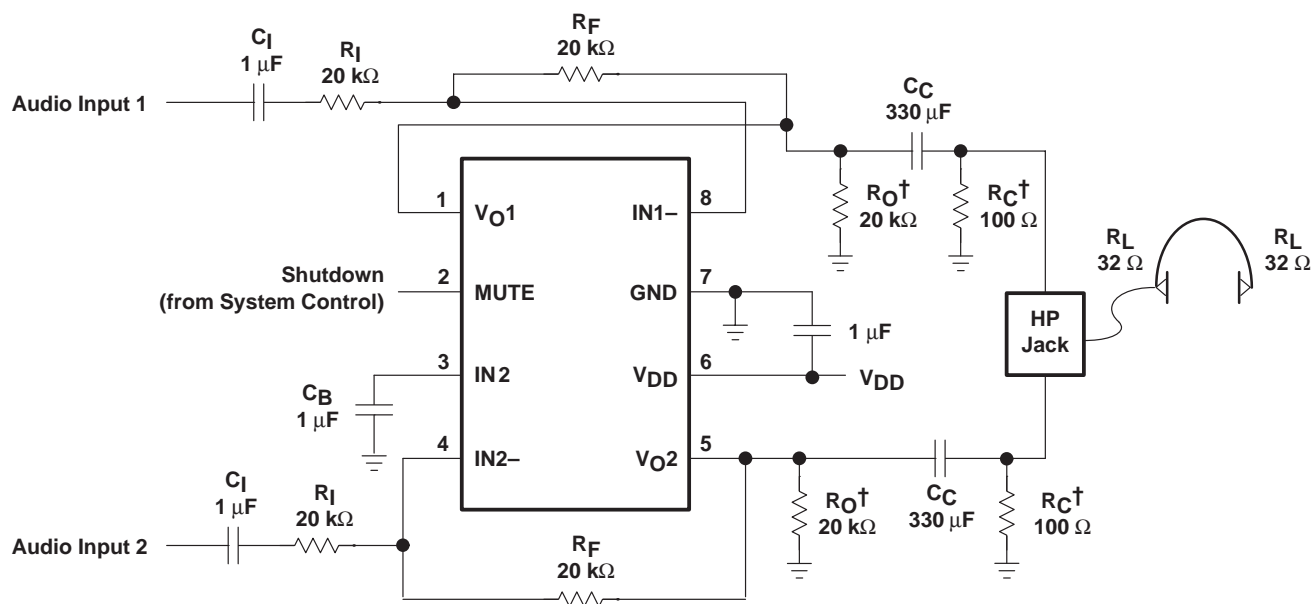

† These resistors are optional. Adding these resistors improves the depop performance of the TPA152.

Figure 22. TPA152 Typical Application Circuit

# TPA152

## 75-mW STEREO AUDIO POWER AMPLIFIER

SLOS210A – JUNE 1998 – REVISED MARCH 2000

### APPLICATION INFORMATION

#### gain setting resistors, $R_F$ and $R_I$

The gain for the TPA152 is set by resistors  $R_F$  and  $R_I$  according to equation 1.

$$\text{Gain} = - \left( \frac{R_F}{R_I} \right) \quad (1)$$

Given that the TPA152 is a MOS amplifier, the input impedance is very high, consequently input leakage currents are not generally a concern although noise in the circuit increases as the value of  $R_F$  increases. In addition, a certain range of  $R_F$  values are required for proper start-up operation of the amplifier. Taken together it is recommended that the effective impedance seen by the inverting node of the amplifier be set between 5 k $\Omega$  and 20 k $\Omega$ . The effective impedance is calculated in equation 2.

$$\text{Effective Impedance} = \frac{R_F R_I}{R_F + R_I} \quad (2)$$

As an example, consider an input resistance of 20 k $\Omega$  and a feedback resistor of 20 k $\Omega$ . The gain of the amplifier would be  $-1$  and the effective impedance at the inverting terminal would be 10 k $\Omega$ , which is within the recommended range.

For high performance applications, metal film resistors are recommended because they tend to have lower noise levels than carbon resistors. For values of  $R_F$  above 50 k $\Omega$ , the amplifier tends to become unstable due to a pole formed from  $R_F$  and the inherent input capacitance of the MOS input structure. For this reason, a small compensation capacitor of approximately 5 pF should be placed in parallel with  $R_F$ . This, in effect, creates a low-pass filter network with the cutoff frequency defined in equation 3.

$$f_{c(\text{lowpass})} = \frac{1}{2\pi R_F C_F} \quad (3)$$

For example if  $R_F$  is 100 k $\Omega$  and  $C_F$  is 5 pF then  $f_{c(\text{lowpass})}$  is 318 kHz, which is well outside the audio range.

#### input capacitor, $C_I$

In the typical application, an input capacitor,  $C_I$ , is required to allow the amplifier to bias the input signal to the proper dc level for optimum operation. In this case,  $C_I$  and  $R_I$  form a high-pass filter with the corner frequency determined in equation 4.

$$f_{c(\text{highpass})} = \frac{1}{2\pi R_I C_I} \quad (4)$$

The value of  $C_I$  is important to consider as it directly affects the bass (low frequency) performance of the circuit. Consider the example where  $R_I$  is 20 k $\Omega$  and the specification calls for a flat bass response down to 20 Hz. Equation 4 is reconfigured as equation 5.

$$C_I = \frac{1}{2\pi R_I f_{c(\text{highpass})}} \quad (5)$$

In this example,  $C_I$  is 0.40  $\mu\text{F}$ , so one would likely choose a value in the range of 0.47  $\mu\text{F}$  to 1  $\mu\text{F}$ . A further consideration for this capacitor is the leakage path from the input source through the input network ( $R_I$ ,  $C_I$ ) and the feedback resistor ( $R_F$ ) to the load. This leakage current creates a dc offset voltage at the input to the amplifier that reduces useful headroom, especially in high-gain applications ( $> 10$ ). For this reason a low-leakage tantalum or ceramic capacitor is the best choice. When polarized capacitors are used, the positive side of the capacitor should face the amplifier input in most applications, as the dc level there is held at  $V_{DD}/2$ , which is likely higher than the source dc level. Please note that it is important to confirm the capacitor polarity in the application.

## APPLICATION INFORMATION

### power supply decoupling, $C_S$

The TPA152 is a high-performance CMOS audio amplifier that requires adequate power supply decoupling to ensure that the output total harmonic distortion (THD) is as low as possible. Power supply decoupling also prevents oscillations for long lead lengths between the amplifier and the speaker. The optimum decoupling is achieved by using two capacitors of different types that target different types of noise on the power supply leads. For higher frequency transients, spikes, or digital hash on the line, a good low equivalent-series-resistance (ESR) ceramic capacitor, typically 0.1  $\mu\text{F}$ , placed as close as possible to the device  $V_{DD}$  lead, works best. For filtering lower-frequency noise signals, a larger aluminum electrolytic capacitor of 10  $\mu\text{F}$  or greater placed near the power amplifier is recommended.

### midrail bypass capacitor, $C_B$

The midrail bypass capacitor,  $C_B$ , serves several important functions. During startup or recovery from shutdown mode,  $C_B$  determines the rate at which the amplifier starts up. This helps to push the start-up pop noise into the subaudible range (so slow it can not be heard). The second function is to reduce noise produced by the power supply caused by coupling into the output drive signal. This noise is from the midrail generation circuit internal to the amplifier. The capacitor is fed from a 160-k $\Omega$  source inside the amplifier. To keep the start-up pop as low as possible, the relationship shown in equation 6 should be maintained.

$$\frac{1}{(C_B \times 160 \text{ k}\Omega)} \leq \frac{1}{(C_I R_I)} \quad (6)$$

As an example, consider a circuit where  $C_B$  is 1  $\mu\text{F}$ ,  $C_I$  is 1  $\mu\text{F}$  and  $R_I$  is 20 k $\Omega$ . Inserting these values into the equation 9 results in:

$$6.25 \leq 50$$

which satisfies the rule. Bypass capacitor,  $C_B$ , values of 0.1  $\mu\text{F}$  to 1  $\mu\text{F}$  ceramic or tantalum low-ESR capacitors are recommended for the best THD and noise performance.

### output coupling capacitor, $C_C$

In the typical single-supply single-ended (SE) configuration, an output coupling capacitor ( $C_C$ ) is required to block the dc bias at the output of the amplifier thus preventing dc currents in the load. As with the input coupling capacitor, the output coupling capacitor and impedance of the load form a high-pass filter governed by equation 7.

$$f_{c(\text{high})} = \frac{1}{2\pi R_L C_C} \quad (7)$$

The main disadvantage, from a performance standpoint, is that the load impedances are typically small, which drive the low-frequency corner higher. Large values of  $C_C$  are required to pass low frequencies into the load. Consider the example where a  $C_C$  of 68  $\mu\text{F}$  is chosen and loads vary from 32  $\Omega$  to 47 k $\Omega$ . Table 1 summarizes the frequency response characteristics of each configuration.

**APPLICATION INFORMATION**

**Table 1. Common Load Impedances vs Low Frequency Output Characteristics in SE Mode**

$R_L$	$C_C$	LOWEST FREQUENCY
32 $\Omega$	68 $\mu\text{F}$	73 Hz
10,000 $\Omega$	68 $\mu\text{F}$	0.23 Hz
47,000 $\Omega$	68 $\mu\text{F}$	0.05 Hz

As Table 1 indicates, headphone response is adequate and drive into line level inputs (a home stereo for example) is very good.

The output coupling capacitor required in single-supply SE mode also places additional constraints on the selection of other components in the amplifier circuit. With the rules described earlier still valid, add the following relationship:

$$\frac{1}{(C_B \times 160 \text{ k}\Omega)} \leq \frac{1}{(C_I R_I)} \ll \frac{1}{R_L C_C} \tag{8}$$

**output pull-down resistor,  $R_C + R_O$**

Placing a 100- $\Omega$  resistor,  $R_C$ , from the output side of the coupling capacitor to ground insures the coupling capacitor,  $C_C$ , is charged before a plug is inserted into the jack. Without this resistor, the coupling capacitor would charge rapidly upon insertion of a plug, leading to an audible pop in the headphones.

Placing a 20-k $\Omega$  resistor,  $R_O$ , from the output of the IC to ground insures that the coupling capacitor fully discharges at power down. If the supply is rapidly cycled without this capacitor, a small pop may be audible in 10-k $\Omega$  loads.

**using low-ESR capacitors**

Low-ESR capacitors are recommended throughout this applications section. A real capacitor can be modeled simply as a resistor in series with an ideal capacitor. The voltage drop across this resistor minimizes the beneficial effects of the capacitor in the circuit. The lower the equivalent value of this resistance, the more the real capacitor behaves like an ideal capacitor.

**PACKAGING INFORMATION**

Orderable Device	Status <sup>(1)</sup>	Package Type	Package Drawing	Pins	Package Qty	Eco Plan <sup>(2)</sup>	Lead/Ball Finish	MSL Peak Temp <sup>(3)</sup>
TPA152D	ACTIVE	SOIC	D	8	75	Green (RoHS & no Sb/Br)	CU NIPDAU	Level-1-260C-UNLIM
TPA152DG4	ACTIVE	SOIC	D	8	75	Green (RoHS & no Sb/Br)	CU NIPDAU	Level-1-260C-UNLIM
TPA152DR	ACTIVE	SOIC	D	8	2500	Green (RoHS & no Sb/Br)	CU NIPDAU	Level-1-260C-UNLIM
TPA152DRG4	ACTIVE	SOIC	D	8	2500	Green (RoHS & no Sb/Br)	CU NIPDAU	Level-1-260C-UNLIM

<sup>(1)</sup> The marketing status values are defined as follows:

**ACTIVE:** Product device recommended for new designs.

**LIFEBUY:** TI has announced that the device will be discontinued, and a lifetime-buy period is in effect.

**NRND:** Not recommended for new designs. Device is in production to support existing customers, but TI does not recommend using this part in a new design.

**PREVIEW:** Device has been announced but is not in production. Samples may or may not be available.

**OBSOLETE:** TI has discontinued the production of the device.

<sup>(2)</sup> Eco Plan - The planned eco-friendly classification: Pb-Free (RoHS), Pb-Free (RoHS Exempt), or Green (RoHS & no Sb/Br) - please check <http://www.ti.com/productcontent> for the latest availability information and additional product content details.

**TBD:** The Pb-Free/Green conversion plan has not been defined.

**Pb-Free (RoHS):** TI's terms "Lead-Free" or "Pb-Free" mean semiconductor products that are compatible with the current RoHS requirements for all 6 substances, including the requirement that lead not exceed 0.1% by weight in homogeneous materials. Where designed to be soldered at high temperatures, TI Pb-Free products are suitable for use in specified lead-free processes.

**Pb-Free (RoHS Exempt):** This component has a RoHS exemption for either 1) lead-based flip-chip solder bumps used between the die and package, or 2) lead-based die adhesive used between the die and leadframe. The component is otherwise considered Pb-Free (RoHS compatible) as defined above.

**Green (RoHS & no Sb/Br):** TI defines "Green" to mean Pb-Free (RoHS compatible), and free of Bromine (Br) and Antimony (Sb) based flame retardants (Br or Sb do not exceed 0.1% by weight in homogeneous material)

<sup>(3)</sup> MSL, Peak Temp. -- The Moisture Sensitivity Level rating according to the JEDEC industry standard classifications, and peak solder temperature.

**Important Information and Disclaimer:**The information provided on this page represents TI's knowledge and belief as of the date that it is provided. TI bases its knowledge and belief on information provided by third parties, and makes no representation or warranty as to the accuracy of such information. Efforts are underway to better integrate information from third parties. TI has taken and continues to take reasonable steps to provide representative and accurate information but may not have conducted destructive testing or chemical analysis on incoming materials and chemicals. TI and TI suppliers consider certain information to be proprietary, and thus CAS numbers and other limited information may not be available for release.

In no event shall TI's liability arising out of such information exceed the total purchase price of the TI part(s) at issue in this document sold by TI to Customer on an annual basis.

## TAPE AND REEL INFORMATION



### QUADRANT ASSIGNMENTS FOR PIN 1 ORIENTATION IN TAPE



\*All dimensions are nominal

Device	Package Type	Package Drawing	Pins	SPQ	Reel Diameter (mm)	Reel Width W1 (mm)	A0 (mm)	B0 (mm)	K0 (mm)	P1 (mm)	W (mm)	Pin1 Quadrant
TPA152DR	SOIC	D	8	2500	330.0	12.4	6.4	5.2	2.1	8.0	12.0	Q1



TAPE AND REEL BOX DIMENSIONS



\*All dimensions are nominal

Device	Package Type	Package Drawing	Pins	SPQ	Length (mm)	Width (mm)	Height (mm)
TPA152DR	SOIC	D	8	2500	346.0	346.0	29.0

## IMPORTANT NOTICE

Texas Instruments Incorporated and its subsidiaries (TI) reserve the right to make corrections, modifications, enhancements, improvements, and other changes to its products and services at any time and to discontinue any product or service without notice. Customers should obtain the latest relevant information before placing orders and should verify that such information is current and complete. All products are sold subject to TI's terms and conditions of sale supplied at the time of order acknowledgment.

TI warrants performance of its hardware products to the specifications applicable at the time of sale in accordance with TI's standard warranty. Testing and other quality control techniques are used to the extent TI deems necessary to support this warranty. Except where mandated by government requirements, testing of all parameters of each product is not necessarily performed.

TI assumes no liability for applications assistance or customer product design. Customers are responsible for their products and applications using TI components. To minimize the risks associated with customer products and applications, customers should provide adequate design and operating safeguards.

TI does not warrant or represent that any license, either express or implied, is granted under any TI patent right, copyright, mask work right, or other TI intellectual property right relating to any combination, machine, or process in which TI products or services are used. Information published by TI regarding third-party products or services does not constitute a license from TI to use such products or services or a warranty or endorsement thereof. Use of such information may require a license from a third party under the patents or other intellectual property of the third party, or a license from TI under the patents or other intellectual property of TI.

Reproduction of TI information in TI data books or data sheets is permissible only if reproduction is without alteration and is accompanied by all associated warranties, conditions, limitations, and notices. Reproduction of this information with alteration is an unfair and deceptive business practice. TI is not responsible or liable for such altered documentation. Information of third parties may be subject to additional restrictions.

Resale of TI products or services with statements different from or beyond the parameters stated by TI for that product or service voids all express and any implied warranties for the associated TI product or service and is an unfair and deceptive business practice. TI is not responsible or liable for any such statements.

TI products are not authorized for use in safety-critical applications (such as life support) where a failure of the TI product would reasonably be expected to cause severe personal injury or death, unless officers of the parties have executed an agreement specifically governing such use. Buyers represent that they have all necessary expertise in the safety and regulatory ramifications of their applications, and acknowledge and agree that they are solely responsible for all legal, regulatory and safety-related requirements concerning their products and any use of TI products in such safety-critical applications, notwithstanding any applications-related information or support that may be provided by TI. Further, Buyers must fully indemnify TI and its representatives against any damages arising out of the use of TI products in such safety-critical applications.

TI products are neither designed nor intended for use in military/aerospace applications or environments unless the TI products are specifically designated by TI as military-grade or "enhanced plastic." Only products designated by TI as military-grade meet military specifications. Buyers acknowledge and agree that any such use of TI products which TI has not designated as military-grade is solely at the Buyer's risk, and that they are solely responsible for compliance with all legal and regulatory requirements in connection with such use.

TI products are neither designed nor intended for use in automotive applications or environments unless the specific TI products are designated by TI as compliant with ISO/TS 16949 requirements. Buyers acknowledge and agree that, if they use any non-designated products in automotive applications, TI will not be responsible for any failure to meet such requirements.

Following are URLs where you can obtain information on other Texas Instruments products and application solutions:

<b>Products</b>		<b>Applications</b>	
Amplifiers	<a href="http://amplifier.ti.com">amplifier.ti.com</a>	Audio	<a href="http://www.ti.com/audio">www.ti.com/audio</a>
Data Converters	<a href="http://dataconverter.ti.com">dataconverter.ti.com</a>	Automotive	<a href="http://www.ti.com/automotive">www.ti.com/automotive</a>
DLP® Products	<a href="http://www.dlp.com">www.dlp.com</a>	Communications and Telecom	<a href="http://www.ti.com/communications">www.ti.com/communications</a>
DSP	<a href="http://dsp.ti.com">dsp.ti.com</a>	Computers and Peripherals	<a href="http://www.ti.com/computers">www.ti.com/computers</a>
Clocks and Timers	<a href="http://www.ti.com/clocks">www.ti.com/clocks</a>	Consumer Electronics	<a href="http://www.ti.com/consumer-apps">www.ti.com/consumer-apps</a>
Interface	<a href="http://interface.ti.com">interface.ti.com</a>	Energy	<a href="http://www.ti.com/energy">www.ti.com/energy</a>
Logic	<a href="http://logic.ti.com">logic.ti.com</a>	Industrial	<a href="http://www.ti.com/industrial">www.ti.com/industrial</a>
Power Mgmt	<a href="http://power.ti.com">power.ti.com</a>	Medical	<a href="http://www.ti.com/medical">www.ti.com/medical</a>
Microcontrollers	<a href="http://microcontroller.ti.com">microcontroller.ti.com</a>	Security	<a href="http://www.ti.com/security">www.ti.com/security</a>
RFID	<a href="http://www.ti-rfid.com">www.ti-rfid.com</a>	Space, Avionics & Defense	<a href="http://www.ti.com/space-avionics-defense">www.ti.com/space-avionics-defense</a>
RF/IF and ZigBee® Solutions	<a href="http://www.ti.com/lprf">www.ti.com/lprf</a>	Video and Imaging	<a href="http://www.ti.com/video">www.ti.com/video</a>
		Wireless	<a href="http://www.ti.com/wireless-apps">www.ti.com/wireless-apps</a>

Mailing Address: Texas Instruments, Post Office Box 655303, Dallas, Texas 75265  
Copyright © 2010, Texas Instruments Incorporated