

TIR1000, TIR1000I STANDALONE IrDA™ ENCODER AND DECODER

SLLS228F – DECEMBER 1995 – REVISED JULY 1999

- Adds Infrared (IR) Port to Universal Asynchronous Receiver Transmitter (UART)
- Compatible With Infrared Data Association (IrDA™) and Hewlett Packard Serial Infrared (HPSIR)
- Provides 1200 bps to 115 kbps Data Rate
- Operates From 2.7 V to 5.5 V
- Provides Simple Interface With UART
- Decodes Negative or Positive Pulses
- Available in Two 8-Terminal Plastic Small Outline Packages (PSOP), PS Package Has Slightly Larger Dimensions Than PW Package

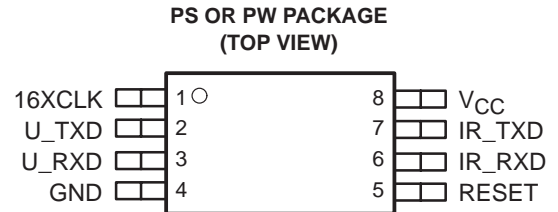

functional block diagram

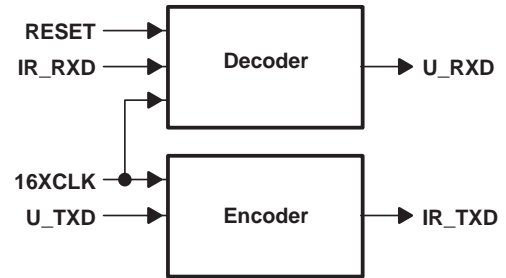

description

The TIR1000 serial infrared (SIR) encoder/decoder is a CMOS device which encodes and decodes bit data in conformance with the IrDA specification.

A transceiver device is needed to interface to the photo-sensitive diode (PIN) and the light emitting diode (LED). A UART is needed to interface to the serial data lines.

Terminal Functions

TERMINAL NAME	NO.	I/O	DESCRIPTION
16XCLK	1	I	Clock signal. 16XCLK should be set to 16 times the baud rate. The highest baud rate for IrDA is 115.2 kbps for which the clock frequency equals 1.843 MHz (this terminal is tied to the BAUDOUT of a UART).
GND	4		Ground
IR_RXD	6	I	Infrared receiver data. IR_RXD is an IrDA-SIR-modulated input from an optoelectronics transceiver whose input pulses should be 3/16 of the baud rate period.
IR_TXD	7	O	Infrared transmitter data. IR_TXD is an IrDA-SIR-modulated output to an optoelectronics transceiver.
RESET	5	I	Active high reset. RESET initializes an IrDA-SIR-decode/encode state machine (this terminal is tied to a UART reset line).
U_RXD	3	O	Receiver data. U_RXD is decoded (demodulated) data from IR_RXD according to the IrDA specification (this terminal is tied to SIN of a UART).
U_TXD	2	I	Transmitter data. U_TXD is encoded (modulated) data and output data as IR_TXD (this terminal is tied to SOUT from a UART).
VCC	8		Supply voltage



Please be aware that an important notice concerning availability, standard warranty, and use in critical applications of Texas Instruments semiconductor products and disclaimers thereto appears at the end of this data sheet.

IrDA is a registered trademark of the Infrared Data Association.

PRODUCTION DATA information is current as of publication date. Products conform to specifications per the terms of Texas Instruments standard warranty. Production processing does not necessarily include testing of all parameters.

 **TEXAS
INSTRUMENTS**

POST OFFICE BOX 655303 • DALLAS, TEXAS 75265

Copyright © 1999, Texas Instruments Incorporated

TIR1000, TIR1000I STANDALONE IrDA™ ENCODER AND DECODER

SLLS228F – DECEMBER 1995 – REVISED JULY 1999

absolute maximum ratings over operating free-air temperature range (unless otherwise noted)†

Supply voltage range, V_{CC} (see Note 1)	–0.5 V to 6 V
Input voltage range at any input, V_I	–0.5 V to $V_{CC} + 0.5$ V
Output voltage range, V_O	–0.5 V to $V_{CC} + 0.5$ V
Operating free-air temperature range, T_A , TIR1000	0°C to 70°C
T_A , TIR1000I	–40°C to 85°C
Storage temperature range, T_{stg}	–65°C to 150°C
Case temperature for 10 seconds: SOP package	260°C

† Stresses beyond those listed under “absolute maximum ratings” may cause permanent damage to the device. These are stress ratings only, and functional operation of the device at these or any other conditions beyond those indicated under “recommended operating conditions” is not implied. Exposure to absolute-maximum-rated conditions for extended periods may affect device reliability.

NOTE 1: All voltage levels are with respect to GND.

recommended operating conditions over recommended operating free-air temperature range

low voltage (3 V nominal)

		MIN	NOM	MAX	UNIT
Supply voltage, V_{CC}		2.7	3	3.3	V
High-level input voltage, V_{IH}		0.7 V_{CC}			V
Low-level input voltage, V_{IL}		0.2 V_{CC}			V
Operating free-air temperature, T_A	TIR1000	0		70	°C
	TIR1000I	–40		85	

standard voltage (5 V nominal)

		MIN	NOM	MAX	UNIT
Supply voltage, V_{CC}		4.5	5	5.5	V
High-level input voltage, V_{IH}		0.7 V_{CC}			V
Low-level input voltage, V_{IL}		0.2 V_{CC}			V
Operating free-air temperature, T_A	TIR1000	0		70	°C
	TIR1000I	–40		85	

electrical characteristics over recommended operating free-air temperature range (unless otherwise noted)

PARAMETER	TEST CONDITIONS	MIN	TYP	MAX	UNIT
V_{OH} High-level output voltage	$I_{OH} = -4$ mA $V_{CC} = 5$ V	$V_{CC} - 0.8$			V
	$I_{OH} = -1.8$ mA $V_{CC} = 3$ V	$V_{CC} - 0.55$			
V_{OL} Low-level output voltage	$I_{OL} = +4$ mA $V_{CC} = 5$ V	0.5			V
	$I_{OL} = +1.8$ mA $V_{CC} = 3$ V	0.5			
I_I Input current	$V_I = 0$ to V_{CC} , All other pins floating	± 3			μ A
I_{CC} Supply current	$V_{CC} = 5.25$ V, $T_A = 25^\circ$ C, All inputs at 0.2 V, 16XCLK at 2 MHz, No load on outputs	1			mA
$C_i(16XCLK)$ Clock input capacitance		5			pF
$f(16XCLK)$ Clock frequency		2			MHz



switching characteristics

PARAMETER		TEST CONDITIONS	MIN	TYP†	MAX	UNIT
t _r	Output rise time	C _(LOAD) = 15 pF (10% to 90%)		1.3		ns
t _f	Output fall time	C _(LOAD) = 15 pF (90% to 10%)		1.8		ns

† Typical values are at T_A = 25°C.

APPLICATION INFORMATION

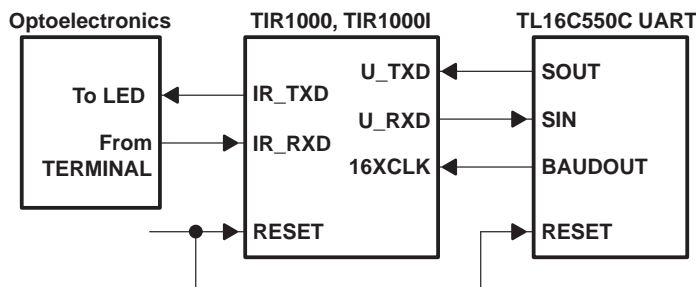

Figure 1. Typical application of the TIR1000, TIR1000I

PRINCIPLES OF OPERATION

IrDA overview

The Infrared Data Association (IrDA) defines several protocols for sending and receiving serial infrared data, including rates of 115.2 kbps, 0.576 Mbps, 1.152 Mbps, and 4 Mbps. The low rate of 115.2 kbps was specified first and the others must maintain downward compatibility with it. At the 115.2 kbps rate, the protocol implemented in the hardware is fairly simple. It primarily defines a serial infrared data *word* to be surrounded by a start bit equal to 0 and a stop bit equal to 1. Individual bits are encoded or decoded the same whether they are start, data, or stop bits. The TIR1000 and TIR1000I evaluate only single bits and only follow the 115.2 kbps protocol. The 115.2 kbps rate is a maximum rate. When both ends of the transfer are set up to a lower but matching speed, the protocol (with the TIR1000 and TIR1000I) still works. The clock used to code or sample the data is 16 times the baud rate, or 1.843 Mhz maximum. To code a 1, no pulse is sent or received for 1-bit time period, or 16 clock cycles. To code a 0, one pulse is sent or received within a 1-bit time period, or 16 clock cycles. The pulse must be at least 1.6 μs wide and 3 clock cycles long at 1.843 Mhz. At lower baud rates the pulse can be 1.6 μs wide or as long as 3 clock cycles. The transmitter output, IR_TXD, is intended to drive a LED circuit to generate an infrared pulse. The LED circuits work on positive pulses. A terminal circuit is expected to create the receiver input, IR_RXD. Most, but not all, PIN circuits have inversion and generate negative pulses from the detected infrared light. Their output is normally high. The TIR1000 and TIR1000I can decode either negative or positive pulses on IR_RXD.

TIR1000, TIR1000I STANDALONE IrDA™ ENCODER AND DECODER

SLLS228F – DECEMBER 1995 – REVISED JULY 1999

PRINCIPLES OF OPERATION

IrDA encoder function

Serial data from a UART is encoded to transmit data to the optoelectronics. While the serial data input to this block (U_TXD) is high, the output (IR_TXD) is always low, and the counter used to form a pulse on IR_TXD is continuously cleared. After U_TXD resets to 0, IR_TXD rises on the falling edge of the seventh 16XCLK. On the falling edge of the tenth 16XCLK pulse, IR_TXD falls, creating a 3-clock-wide pulse. While U_TXD stays low, a pulse is transmitted during the seventh to tenth clocks of each 16-clock bit cycle.

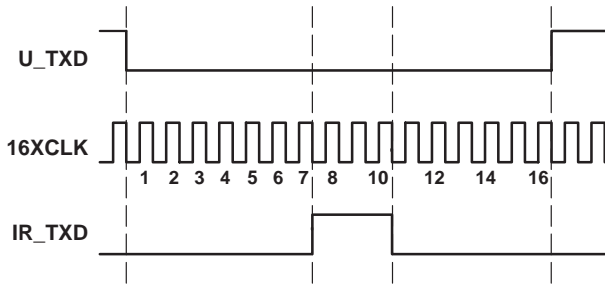

Figure 2. IrDA-SIR Encoding Scheme – Detailed Timing Diagram

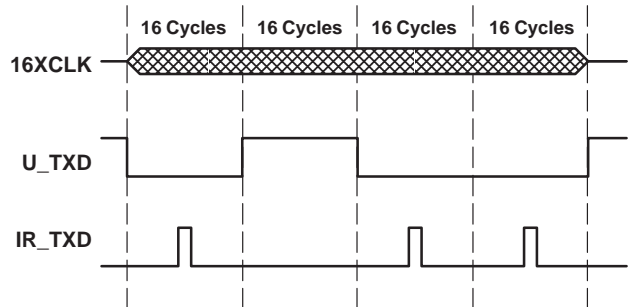

Figure 3. Encoding Scheme – Macro View

IrDA decoder function

After reset, U_RXD is high and the 4-bit counter is cleared. When a falling edge is detected on IR_RXD, U_RXD falls on the next rising edge of 16XCLK with sufficient setup time. U_RXD stays low for 16 cycles (16XCLK) and then returns to high as required by the IrDA specification. As long as no pulses (falling edges) are detected on IR_RXD, U_RXD remains high.

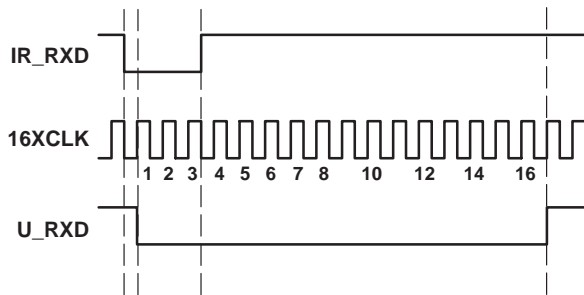

Figure 4. IrDA-SIR Decoding Scheme – Detailed Timing Diagram

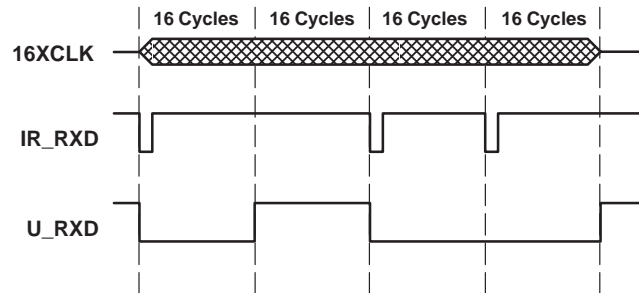

Figure 5. Decoding Scheme – Macro View

PRINCIPLES OF OPERATION

IrDA encoder function (continued)

It is possible for jitter or slight frequency differences to cause the next falling edge on IR_RXD to be missed for one 16XCLK cycle. In that case, a 1-clock-wide pulse appears on U_RXD between consecutive zeroes. It is important for the UART to strobe U_RXD in the middle of the bit time to avoid latching this 1-clock-wide pulse. The TL16C550C UART already strobes incoming serial data at the proper time. Otherwise, note that data is required to be framed by a leading zero and a trailing one. The falling edge of that first zero on U_RXD synchronizes the read strobe. The strobe occurs on the eighth 16XCLK pulse after the U_RXD falling edge and once every 16 cycles thereafter until the stop bit occurs.

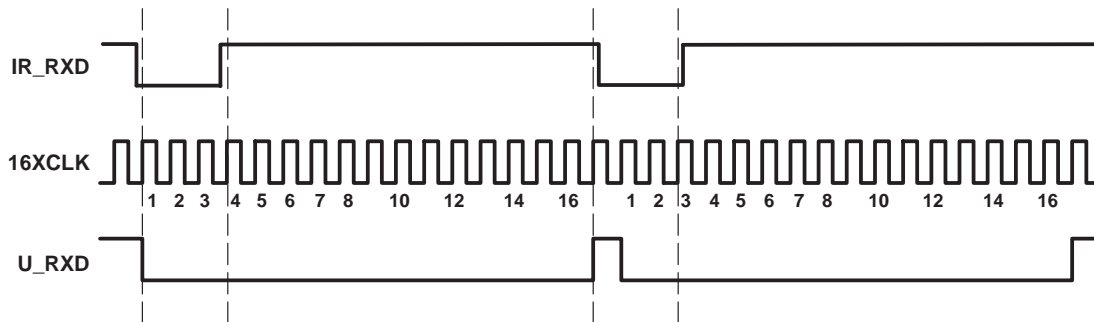

Figure 6. Timing Causing 1-clock-wide Pulse Between Consecutive Ones

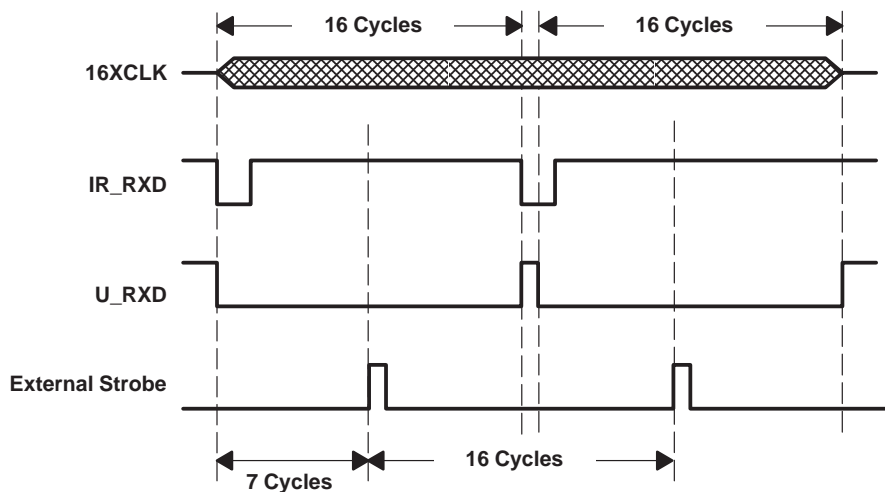

Figure 7. Recommended Strobing For Decoded Data

PRINCIPLES OF OPERATION

IrDA encoder function (continued)

The TIR1000 and TIR1000I can decode positive pulses on IR_RXD. The timing is different, but the variation is invisible to the UART. The decoder, which works from the falling edge, now recognizes a zero on the trailing edge of the pulse rather than on the leading edge. As long as the pulse width is fairly constant, as defined by the specification, the trailing edges should also be 16 clock cycles apart and data can readily be decoded. The zero appears on U_RXD after the pulse rather than at the start of it.

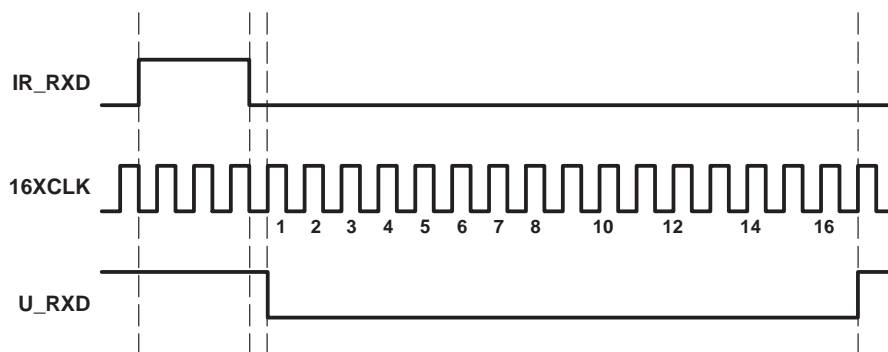

Figure 8. Positive IR_RXD Pulse Decode – Detailed View

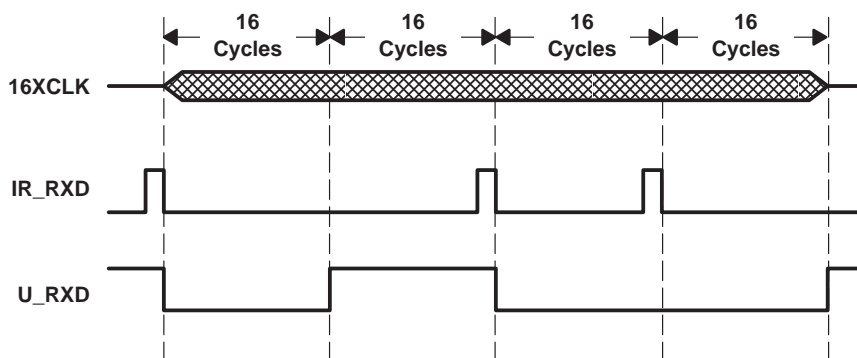

Figure 9. Positive IR_RXD Pulse Decode – Macro View

PACKAGING INFORMATION

Orderable Device	Status ⁽¹⁾	Package Type	Package Drawing	Pins	Package Qty	Eco Plan ⁽²⁾	Lead/ Ball Finish	MSL Peak Temp ⁽³⁾	Samples (Requires Login)
TIR1000IPS	ACTIVE	SO	PS	8	80	Green (RoHS & no Sb/Br)	CU NIPDAU	Level-1-260C-UNLIM	Purchase Samples
TIR1000IPSR	ACTIVE	SO	PS	8	2000	Green (RoHS & no Sb/Br)	CU NIPDAU	Level-1-260C-UNLIM	Purchase Samples
TIR1000IPW	ACTIVE	TSSOP	PW	8	150	Green (RoHS & no Sb/Br)	CU NIPDAU	Level-1-260C-UNLIM	Contact TI Distributor or Sales Office
TIR1000IPWG4	ACTIVE	TSSOP	PW	8	150	Green (RoHS & no Sb/Br)	CU NIPDAU	Level-1-260C-UNLIM	Contact TI Distributor or Sales Office
TIR1000IPWR	ACTIVE	TSSOP	PW	8	2000	Green (RoHS & no Sb/Br)	CU NIPDAU	Level-1-260C-UNLIM	Purchase Samples
TIR1000IPWRG4	ACTIVE	TSSOP	PW	8	2000	Green (RoHS & no Sb/Br)	CU NIPDAU	Level-1-260C-UNLIM	Purchase Samples
TIR1000PSLE	OBSOLETE	SO	PS	8		TBD	Call TI	Call TI	Replaced by TIR1000PSR
TIR1000PSR	ACTIVE	SO	PS	8	2000	Green (RoHS & no Sb/Br)	CU NIPDAU	Level-1-260C-UNLIM	Request Free Samples
TIR1000PSRG4	ACTIVE	SO	PS	8	2000	Green (RoHS & no Sb/Br)	CU NIPDAU	Level-1-260C-UNLIM	Request Free Samples
TIR1000PWLE	OBSOLETE	TSSOP	PW	8		TBD	Call TI	Call TI	Replaced by TIR1000PWR
TIR1000PWR	ACTIVE	TSSOP	PW	8	2000	Green (RoHS & no Sb/Br)	CU NIPDAU	Level-1-260C-UNLIM	Request Free Samples
TIR1000PWRG4	ACTIVE	TSSOP	PW	8	2000	Green (RoHS & no Sb/Br)	CU NIPDAU	Level-1-260C-UNLIM	Request Free Samples

⁽¹⁾ The marketing status values are defined as follows:

ACTIVE: Product device recommended for new designs.

LIFEBUY: TI has announced that the device will be discontinued, and a lifetime-buy period is in effect.

NRND: Not recommended for new designs. Device is in production to support existing customers, but TI does not recommend using this part in a new design.

PREVIEW: Device has been announced but is not in production. Samples may or may not be available.

OBSOLETE: TI has discontinued the production of the device.

⁽²⁾ Eco Plan - The planned eco-friendly classification: Pb-Free (RoHS), Pb-Free (RoHS Exempt), or Green (RoHS & no Sb/Br) - please check <http://www.ti.com/productcontent> for the latest availability information and additional product content details.

TBD: The Pb-Free/Green conversion plan has not been defined.

Pb-Free (RoHS): TI's terms "Lead-Free" or "Pb-Free" mean semiconductor products that are compatible with the current RoHS requirements for all 6 substances, including the requirement that lead not exceed 0.1% by weight in homogeneous materials. Where designed to be soldered at high temperatures, TI Pb-Free products are suitable for use in specified lead-free processes.

Pb-Free (RoHS Exempt): This component has a RoHS exemption for either 1) lead-based flip-chip solder bumps used between the die and package, or 2) lead-based die adhesive used between the die and leadframe. The component is otherwise considered Pb-Free (RoHS compatible) as defined above.

Green (RoHS & no Sb/Br): TI defines "Green" to mean Pb-Free (RoHS compatible), and free of Bromine (Br) and Antimony (Sb) based flame retardants (Br or Sb do not exceed 0.1% by weight in homogeneous material)

⁽³⁾ MSL, Peak Temp. -- The Moisture Sensitivity Level rating according to the JEDEC industry standard classifications, and peak solder temperature.

Important Information and Disclaimer:The information provided on this page represents TI's knowledge and belief as of the date that it is provided. TI bases its knowledge and belief on information provided by third parties, and makes no representation or warranty as to the accuracy of such information. Efforts are underway to better integrate information from third parties. TI has taken and continues to take reasonable steps to provide representative and accurate information but may not have conducted destructive testing or chemical analysis on incoming materials and chemicals. TI and TI suppliers consider certain information to be proprietary, and thus CAS numbers and other limited information may not be available for release.

In no event shall TI's liability arising out of such information exceed the total purchase price of the TI part(s) at issue in this document sold by TI to Customer on an annual basis.

TAPE AND REEL INFORMATION

QUADRANT ASSIGNMENTS FOR PIN 1 ORIENTATION IN TAPE

*All dimensions are nominal

Device	Package Type	Package Drawing	Pins	SPQ	Reel Diameter (mm)	Reel Width W1 (mm)	A0 (mm)	B0 (mm)	K0 (mm)	P1 (mm)	W (mm)	Pin1 Quadrant
TIR1000IPSR	SO	PS	8	2000	330.0	16.4	8.2	6.6	2.5	12.0	16.0	Q1
TIR1000IPWR	TSSOP	PW	8	2000	330.0	12.4	7.0	3.6	1.6	8.0	12.0	Q1
TIR1000PSR	SO	PS	8	2000	330.0	16.4	8.2	6.6	2.5	12.0	16.0	Q1
TIR1000PWR	TSSOP	PW	8	2000	330.0	12.4	7.0	3.6	1.6	8.0	12.0	Q1

TAPE AND REEL BOX DIMENSIONS

*All dimensions are nominal

Device	Package Type	Package Drawing	Pins	SPQ	Length (mm)	Width (mm)	Height (mm)
TIR1000IPSR	SO	PS	8	2000	346.0	346.0	33.0
TIR1000IPWR	TSSOP	PW	8	2000	346.0	346.0	29.0
TIR1000PSR	SO	PS	8	2000	346.0	346.0	33.0
TIR1000PWR	TSSOP	PW	8	2000	346.0	346.0	29.0

PW (R-PDSO-G28)

PLASTIC SMALL OUTLINE



4040064-7/G 02/11

- NOTES:
- A. All linear dimensions are in millimeters. Dimensioning and tolerancing per ASME Y14.5M-1994.
 - B. This drawing is subject to change without notice.
 - C. Body length does not include mold flash, protrusions, or gate burrs. Mold flash, protrusions, or gate burrs shall not exceed 0,15 each side.
 - D. Body width does not include interlead flash. Interlead flash shall not exceed 0,25 each side.
 - E. Falls within JEDEC MO-153

MECHANICAL DATA

PS (R-PDSO-G8)

PLASTIC SMALL-OUTLINE PACKAGE



- NOTES:
- A. All linear dimensions are in millimeters.
 - B. This drawing is subject to change without notice.
 - C. Body dimensions do not include mold flash or protrusion, not to exceed 0,15.

PS (R-PDSO-G8)

PLASTIC SMALL OUTLINE



- NOTES:
- A. All linear dimensions are in millimeters.
 - B. This drawing is subject to change without notice.
 - C. Publication IPC-7351 is recommended for alternate designs.
 - D. Laser cutting apertures with trapezoidal walls and also rounding corners will offer better paste release. Customers should contact their board assembly site for stencil design recommendations. Refer to IPC-7525 for other stencil recommendations.
 - E. Customers should contact their board fabrication site for solder mask tolerances between and around signal pads.

PW (R-PDSO-G8)

PLASTIC SMALL OUTLINE

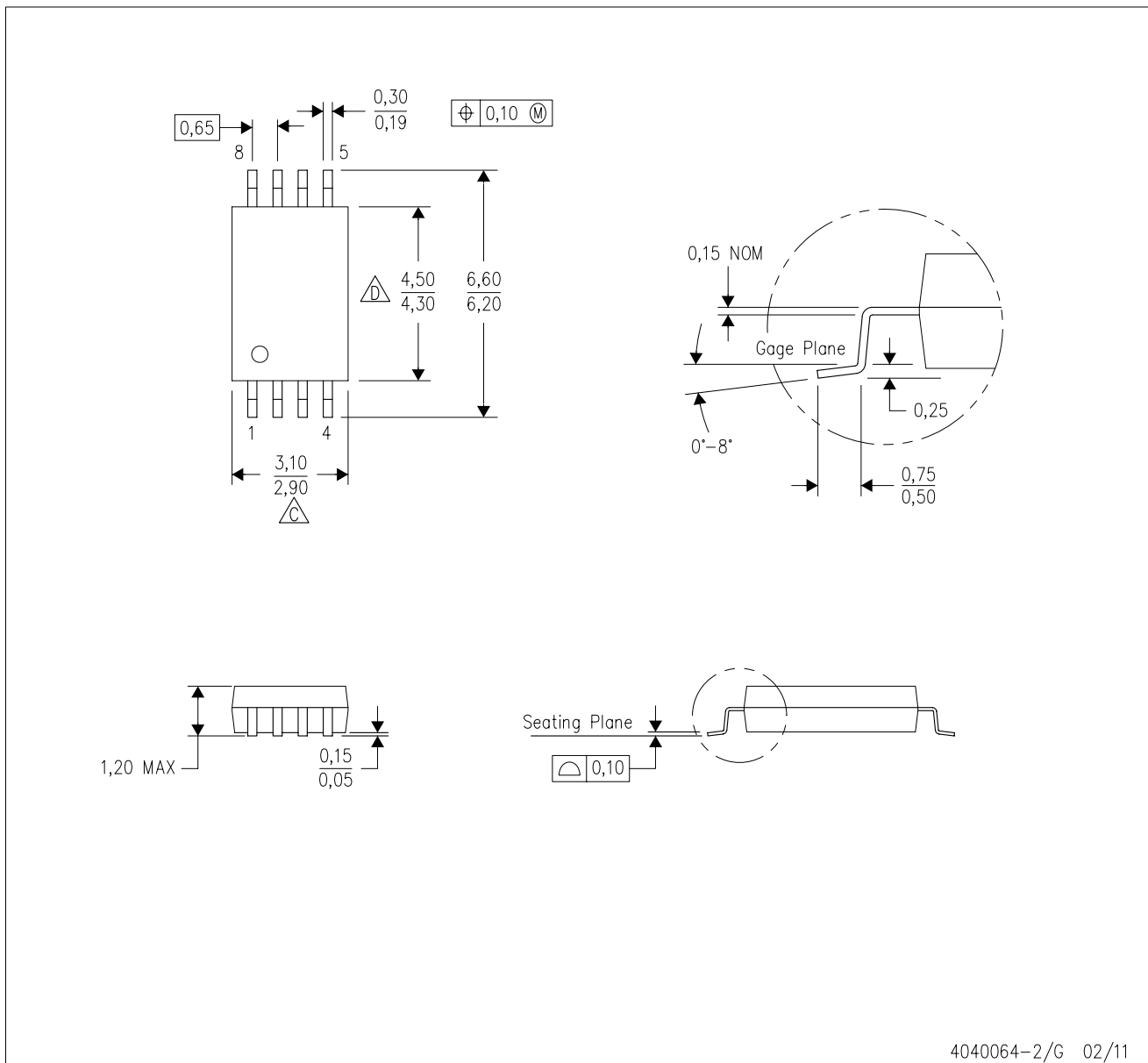

4040064-2/G 02/11

- NOTES:
- A. All linear dimensions are in millimeters. Dimensioning and tolerancing per ASME Y14.5M-1994.
 - B. This drawing is subject to change without notice.
 -  C. Body length does not include mold flash, protrusions, or gate burrs. Mold flash, protrusions, or gate burrs shall not exceed 0,15 each side.
 -  D. Body width does not include interlead flash. Interlead flash shall not exceed 0,25 each side.
 - E. Falls within JEDEC MO-153

IMPORTANT NOTICE

Texas Instruments Incorporated and its subsidiaries (TI) reserve the right to make corrections, modifications, enhancements, improvements, and other changes to its products and services at any time and to discontinue any product or service without notice. Customers should obtain the latest relevant information before placing orders and should verify that such information is current and complete. All products are sold subject to TI's terms and conditions of sale supplied at the time of order acknowledgment.

TI warrants performance of its hardware products to the specifications applicable at the time of sale in accordance with TI's standard warranty. Testing and other quality control techniques are used to the extent TI deems necessary to support this warranty. Except where mandated by government requirements, testing of all parameters of each product is not necessarily performed.

TI assumes no liability for applications assistance or customer product design. Customers are responsible for their products and applications using TI components. To minimize the risks associated with customer products and applications, customers should provide adequate design and operating safeguards.

TI does not warrant or represent that any license, either express or implied, is granted under any TI patent right, copyright, mask work right, or other TI intellectual property right relating to any combination, machine, or process in which TI products or services are used. Information published by TI regarding third-party products or services does not constitute a license from TI to use such products or services or a warranty or endorsement thereof. Use of such information may require a license from a third party under the patents or other intellectual property of the third party, or a license from TI under the patents or other intellectual property of TI.

Reproduction of TI information in TI data books or data sheets is permissible only if reproduction is without alteration and is accompanied by all associated warranties, conditions, limitations, and notices. Reproduction of this information with alteration is an unfair and deceptive business practice. TI is not responsible or liable for such altered documentation. Information of third parties may be subject to additional restrictions.

Resale of TI products or services with statements different from or beyond the parameters stated by TI for that product or service voids all express and any implied warranties for the associated TI product or service and is an unfair and deceptive business practice. TI is not responsible or liable for any such statements.

TI products are not authorized for use in safety-critical applications (such as life support) where a failure of the TI product would reasonably be expected to cause severe personal injury or death, unless officers of the parties have executed an agreement specifically governing such use. Buyers represent that they have all necessary expertise in the safety and regulatory ramifications of their applications, and acknowledge and agree that they are solely responsible for all legal, regulatory and safety-related requirements concerning their products and any use of TI products in such safety-critical applications, notwithstanding any applications-related information or support that may be provided by TI. Further, Buyers must fully indemnify TI and its representatives against any damages arising out of the use of TI products in such safety-critical applications.

TI products are neither designed nor intended for use in military/aerospace applications or environments unless the TI products are specifically designated by TI as military-grade or "enhanced plastic." Only products designated by TI as military-grade meet military specifications. Buyers acknowledge and agree that any such use of TI products which TI has not designated as military-grade is solely at the Buyer's risk, and that they are solely responsible for compliance with all legal and regulatory requirements in connection with such use.

TI products are neither designed nor intended for use in automotive applications or environments unless the specific TI products are designated by TI as compliant with ISO/TS 16949 requirements. Buyers acknowledge and agree that, if they use any non-designated products in automotive applications, TI will not be responsible for any failure to meet such requirements.

Following are URLs where you can obtain information on other Texas Instruments products and application solutions:

Products

Audio	www.ti.com/audio
Amplifiers	amplifier.ti.com
Data Converters	dataconverter.ti.com
DLP® Products	www.dlp.com
DSP	dsp.ti.com
Clocks and Timers	www.ti.com/clocks
Interface	interface.ti.com
Logic	logic.ti.com
Power Mgmt	power.ti.com
Microcontrollers	microcontroller.ti.com
RFID	www.ti-rfid.com
OMAP Mobile Processors	www.ti.com/omap
Wireless Connectivity	www.ti.com/wirelessconnectivity

Applications

Communications and Telecom	www.ti.com/communications
Computers and Peripherals	www.ti.com/computers
Consumer Electronics	www.ti.com/consumer-apps
Energy and Lighting	www.ti.com/energy
Industrial	www.ti.com/industrial
Medical	www.ti.com/medical
Security	www.ti.com/security
Space, Avionics and Defense	www.ti.com/space-avionics-defense
Transportation and Automotive	www.ti.com/automotive
Video and Imaging	www.ti.com/video

TI E2E Community Home Page

e2e.ti.com

Mailing Address: Texas Instruments, Post Office Box 655303, Dallas, Texas 75265
Copyright © 2011, Texas Instruments Incorporated