

Features

- Fast Switching Speed
- Surface Mount Package Ideally Suited for Automated Insertion
- High Reverse Breakdown Voltage
- Dual Series Configuration
- **Lead, Halogen and Antimony Free, RoHS Compliant "Green" Device (Notes 3 and 4)**
- **Qualified to AEC-Q101 Standards for High Reliability**

Mechanical Data

- Case: SOT-23
- Case Material: Molded Plastic. UL Flammability Classification Rating 94V-0
- Moisture Sensitivity: Level 1 per J-STD-020D
- Terminals: Solderable per MIL-STD-202, Method 208
- Lead Free Plating (Matte Tin Finish annealed over Alloy 42 leadframe).
- Polarity: See Diagram
- Ordering Information: See Page 2
- Marking Information: See Page 2
- Weight: 0.008 grams (approximate)

SOT-23

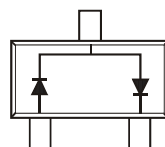

TOP VIEW

 TOP VIEW
Internal Schematic

Maximum Ratings @ $T_A = 25^\circ\text{C}$ unless otherwise specified

Characteristic	Symbol	Value	Unit	
Repetitive Peak Reverse Voltage	V_{RRM}	300	V	
Working Peak Reverse Voltage	V_{RWM}	240	V	
DC Blocking Voltage	V_R			
RMS Reverse Voltage	$V_{R(RMS)}$	170	V	
Forward Continuous Current (Note 2)	I_{FM}	225	mA	
Peak Repetitive Forward Current (Note 2)	I_{FRM}	625	mA	
Non-Repetitive Peak Forward Surge Current	I_{FSM}	@ $t = 1.0\mu\text{s}$ @ $t = 1.0\text{s}$	4.0 1.0	A

Thermal Characteristics

Characteristic	Symbol	Value	Unit
Power Dissipation (Note 2)	P_D	350	mW
Thermal Resistance Junction to Ambient Air (Note 2)	$R_{\theta JA}$	357	$^\circ\text{C/W}$
Operating and Storage Temperature Range	T_J, T_{STG}	-65 to +150	$^\circ\text{C}$

Electrical Characteristics @ $T_A = 25^\circ\text{C}$ unless otherwise specified

Characteristic	Symbol	Min	Max	Unit	Test Condition
Reverse Breakdown Voltage (Note 1)	$V_{(BR)R}$	300	—	V	$I_R = 100\mu\text{A}$
Forward Voltage	V_F	—	0.87 1.0	V	$I_F = 20\text{mA}$ $I_F = 100\text{mA}$
Reverse Current (Note 1)	I_R	—	100	nA μA	$V_R = 240\text{V}$ $V_R = 240\text{V}, T_J = 150^\circ\text{C}$
Total Capacitance	C_T	—	5.0	pF	$V_R = 0, f = 1.0\text{MHz}$
Reverse Recovery Time	t_{rr}	—	50	ns	$I_F = I_R = 30\text{mA}$, $I_{rr} = 3.0\text{mA}, R_L = 100\Omega$

- Notes:
1. Short duration pulse test used to minimize self-heating effect.
 2. Part mounted on FR-4 board with recommended pad layout, which can be found on our website at <http://www.diodes.com/datasheets/ap02001.pdf>.
 3. No purposefully added lead. Halogen and Antimony Free.
 4. Product manufactured with Data Code V9 (week 33, 2008) and newer are built with Green Molding Compound. Product manufactured prior to Date Code V9 are built with Non-Green Molding Compound and may contain Halogens or Sb_2O_3 Fire Retardants.

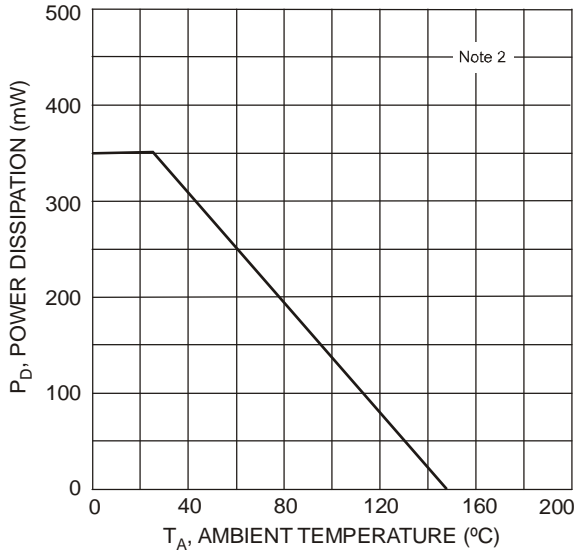

Fig. 1 Power Derating Curve, Total Package

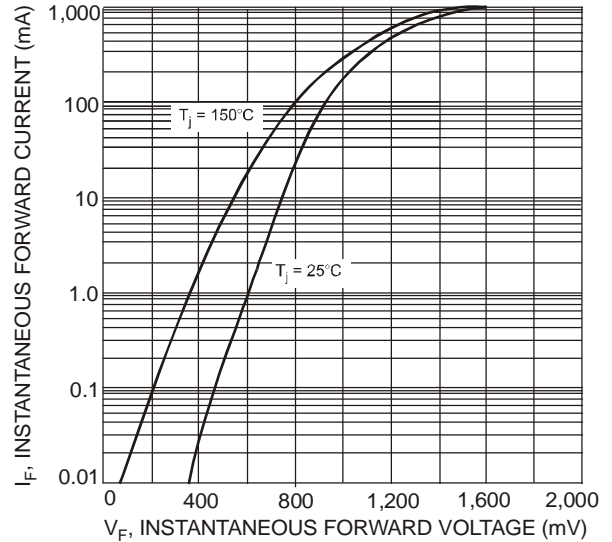

Fig. 2 Typical Forward Characteristics, Per Element

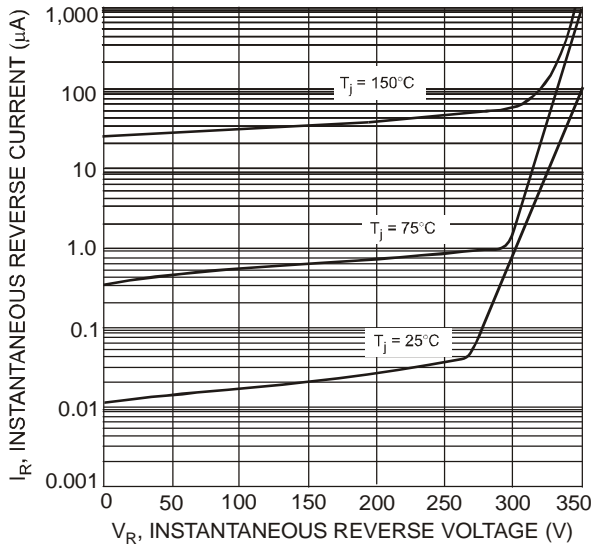

Fig. 3 Typical Reverse Characteristics, Per Element

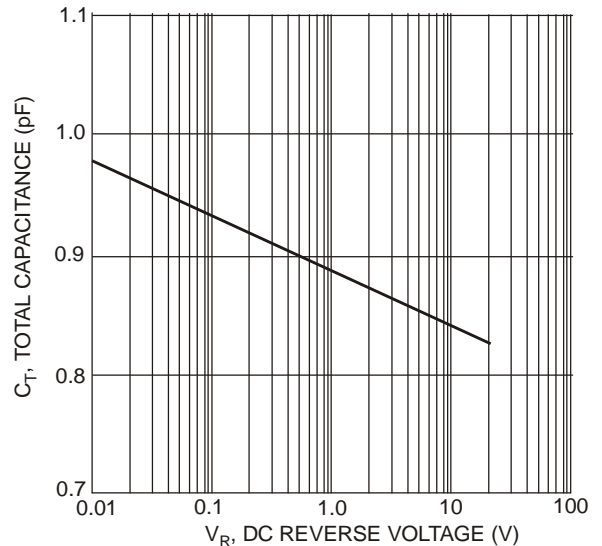

Fig. 4 Total Capacitance vs. Reverse Voltage Per Element

Ordering Information (Note 5)

Part Number	Case	Packaging
MMBD2004S-7-F	SOT-23	3000/Tape & Reel

Notes: 5. For packaging details, go to our website at <http://www.diodes.com/datasheets/ap02007.pdf>.

Marking Information

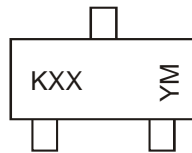

Kxx = Product Type Marking Code (KA9 or KAE)
 YM = Date Code Marking
 Y = Year ex: T = 2006
 M = Month ex: 9 = September

Date Code Key

Year	2001	2002	2003	2004	2005	2006	2007	2008	2009	2010	2011	2012
Code	M	N	P	R	S	T	U	V	W	X	Y	Z
Month	Jan	Feb	Mar	Apr	May	Jun	Jul	Aug	Sep	Oct	Nov	Dec
Code	1	2	3	4	5	6	7	8	9	O	N	D

Package Outline Dimensions

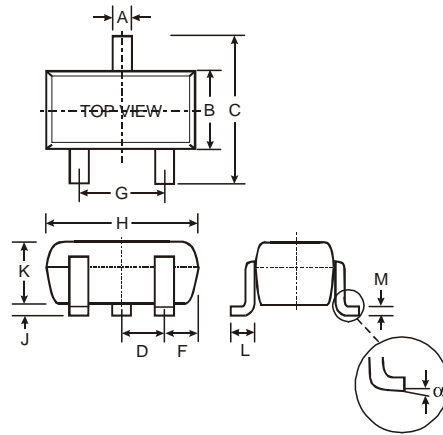

SOT-23		
Dim	Min	Max
A	0.37	0.51
B	1.20	1.40
C	2.30	2.50
D	0.89	1.03
F	0.45	0.60
G	1.78	2.05
H	2.80	3.00
J	0.013	0.10
K	0.903	1.10
L	0.45	0.61
M	0.085	0.180
α	0°	8°
All Dimensions in mm		

Suggested Pad Layout

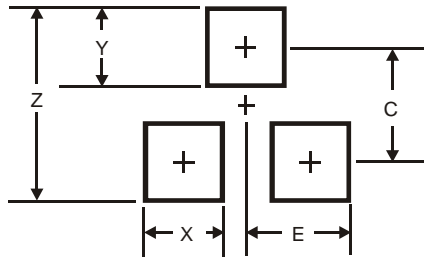

Dimensions	Value (in mm)
Z	2.9
X	0.8
Y	0.9
C	2.0
E	1.35

IMPORTANT NOTICE

Diodes Incorporated and its subsidiaries reserve the right to make modifications, enhancements, improvements, corrections or other changes without further notice to any product herein. Diodes Incorporated does not assume any liability arising out of the application or use of any product described herein; neither does it convey any license under its patent rights, nor the rights of others. The user of products in such applications shall assume all risks of such use and will agree to hold Diodes Incorporated and all the companies whose products are represented on our website, harmless against all damages.

LIFE SUPPORT

Diodes Incorporated products are not authorized for use as critical components in life support devices or systems without the expressed written approval of the President of Diodes Incorporated.