

DATA SHEET

For a complete data sheet, please also download:

- The IC04 LOCMOS HE4000B Logic Family Specifications HEF, HEC
- The IC04 LOCMOS HE4000B Logic Package Outlines/Information HEF, HEC

HEF4528B

MSI

Dual monostable multivibrator

Product specification
File under Integrated Circuits, IC04

January 1995

Dual monostable multivibrator

HEF4528B MSI

DESCRIPTION

The HEF4528B is a dual retriggerable-resettable monostable multivibrator. Each multivibrator has an active LOW input (\bar{I}_0), and active HIGH input (I_1), an active LOW clear direct input (\bar{C}_D), an output (O) and its complement (\bar{O}), and two pins for connecting the external timing components ($C_{TC}^{(1)}$, RC_{TC}).

An external timing capacitor (C_t) must be connected between C_{TC} and RC_{TC} and an external resistor (R_t) must be connected between RC_{TC} and V_{DD} . The duration of the

(1) Always connected to ground.

output pulse is determined by the external timing components C_t and R_t .

A HIGH to LOW transition on \bar{I}_0 when I_1 is LOW or a LOW to HIGH transition on I_1 when \bar{I}_0 is HIGH produces a positive pulse (LOW-HIGH-LOW) and O and a negative pulse (HIGH-LOW-HIGH) on \bar{O} if the \bar{C}_D is HIGH. A LOW

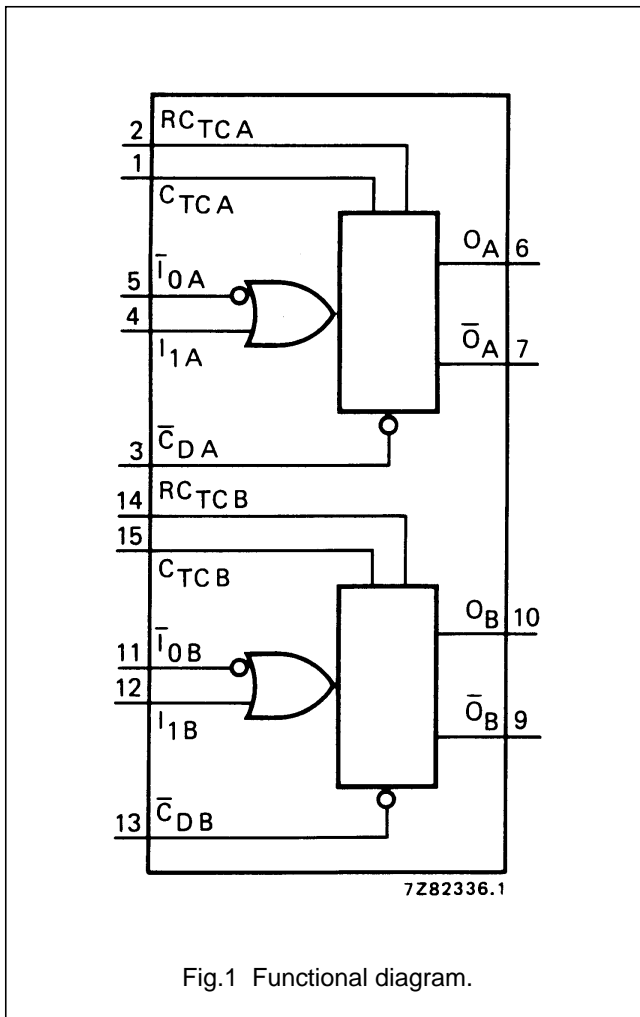

Fig.1 Functional diagram.

on \bar{C}_D forces O LOW, O HIGH and inhibits any further pulses until \bar{C}_D is HIGH.

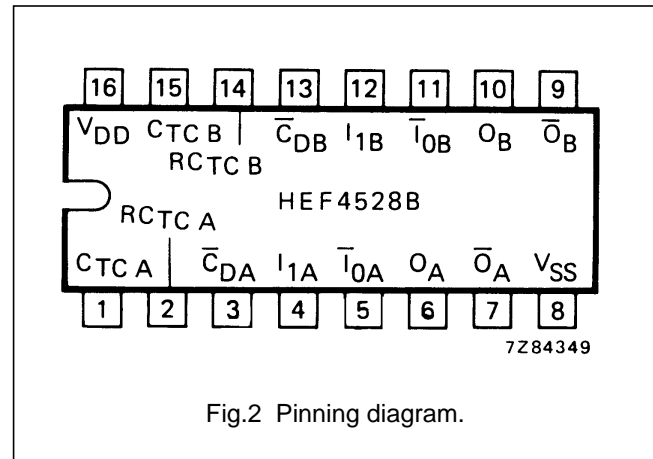

Fig.2 Pinning diagram.

- HEF4528BP(N): 16-lead DIL; plastic (SOT38-1)
- HEF4528BD(F): 16-lead DIL; ceramic (cerdip) (SOT74)
- HEF4528BT(D): 16-lead SO; plastic (SOT109-1)
- (): Package Designator North America

PINNING

- $\bar{I}_{0A}, \bar{I}_{0B}$ input (HIGH to LOW triggered)
- I_{1A}, I_{1B} input (LOW to HIGH triggered)
- $\bar{C}_{DA}, \bar{C}_{DB}$ clear direct input (active LOW)
- O_A, O_B output
- \bar{O}_A, \bar{O}_B complementary output (active LOW)
- $C_{TC A}, C_{TC B}$ external capacitor connections ⁽¹⁾
- $RC_{TC A}, RC_{TC B}$ external capacitor/ resistor connections

FAMILY DATA, I_{DD} LIMITS category MSI

See Family Specifications

Dual monostable multivibrator

HEF4528B
MSI

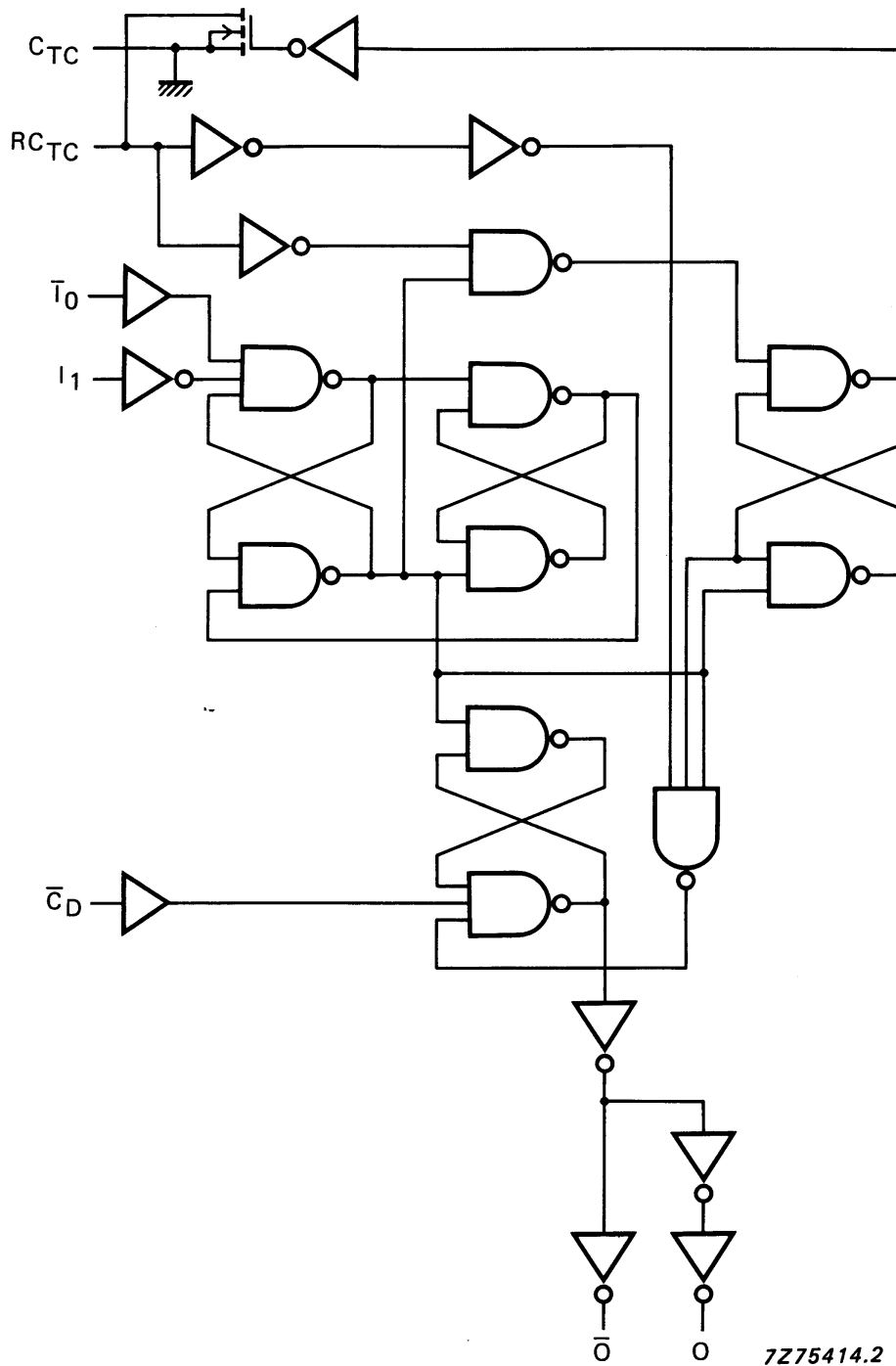







Fig.3 Logic diagram (one monostable multivibrator).





Dual monostable multivibrator

HEF4528B
MSI

FUNCTION TABLE

| INPUTS | | | OUTPUTS | |
|---|---|-------------|---|---|
| \bar{I}_0 | I_1 | \bar{C}_D | O | \bar{O} |
|  | L | H |  |  |
| H |  | H |  |  |
| X | X | L | L | H |

Notes

1. H = HIGH state (the more positive voltage)
2. L = LOW state (the less positive voltage)
3. X = state is immaterial
4.  = positive-going transition
5.  = negative-going transition
6.   = positive or negative output pulse; width is determined by C_t and R_t

AC CHARACTERISTICS

 $V_{SS} = 0$ V; $T_{amb} = 25$ °C; $C_L = 50$ pF; input transition times ≤ 20 ns

| | V_{DD} V | SYMBOL | MIN. | TYP. | MAX. | TYPICAL EXTRAPOLATION FORMULA | |
|--|---------------|-----------|------|------|------|----------------------------------|-----------------------------|
| Propagation delays $\bar{I}_0, I_1 \rightarrow \bar{O}$ HIGH to LOW $\bar{I}_0, I_1 \rightarrow O$ LOW to HIGH $\bar{C}_D \rightarrow O$ HIGH to LOW $\bar{C}_D \rightarrow \bar{O}$ LOW to HIGH | 5 | | | 140 | 280 | ns | 113 ns + (0,55 ns/pF) C_L |
| | 10 | t_{PHL} | | 50 | 100 | ns | 39 ns + (0,23 ns/pF) C_L |
| | 15 | | | 35 | 70 | ns | 27 ns + (0,16 ns/pF) C_L |
| | 5 | | | 155 | 305 | ns | 128 ns + (0,55 ns/pF) C_L |
| | 10 | t_{PLH} | | 60 | 115 | ns | 49 ns + (0,23 ns/pF) C_L |
| | 15 | | | 40 | 80 | ns | 32 ns + (0,16 ns/pF) C_L |
| | 5 | | | 105 | 210 | ns | 78 ns + (0,55 ns/pF) C_L |
| | 10 | t_{PHL} | | 40 | 85 | ns | 29 ns + (0,23 ns/pF) C_L |
| | 15 | | | 30 | 60 | ns | 22 ns + (0,16 ns/pF) C_L |
| Output transition times HIGH to LOW LOW to HIGH | 5 | | | 60 | 120 | ns | 10 ns + (1,0 ns/pF) C_L |
| | 10 | t_{THL} | | 30 | 60 | ns | 9 ns + (0,42 ns/pF) C_L |
| | 15 | | | 20 | 40 | ns | 6 ns + (0,28 ns/pF) C_L |
| | 5 | | | 60 | 120 | ns | 10 ns + (1,0 ns/pF) C_L |
| | 10 | t_{TLH} | | 30 | 60 | ns | 9 ns + (0,42 ns/pF) C_L |
| | 15 | | | 20 | 40 | ns | 6 ns + (0,28 ns/pF) C_L |

Dual monostable multivibrator

HEF4528B
MSI**AC CHARACTERISTICS** $V_{SS} = 0\text{ V}$; $T_{amb} = 25\text{ °C}$; input transition times $\leq 20\text{ ns}$; $R_t = 5\text{ k}\Omega$; $C_t = 15\text{ pF}$

| | V_{DD} V | TYPICAL FORMULA FOR P (μW) | |
|-----------------|---------------|--|---|
| Dynamic power | 5 | $4000 f_i + \sum (f_o C_L) \times V_{DD}^2$ | where f_i = input freq. (MHz) f_o = output freq. (MHz) C_L = load capacitance (pF) $\sum (f_o C_L)$ = sum of outputs V_{DD} = supply voltage (V) |
| dissipation per | 10 | $20\,000 f_i + \sum (f_o C_L) \times V_{DD}^2$ | |
| package (P) | 15 | $59\,000 f_i + \sum (f_o C_L) \times V_{DD}^2$ | |

AC CHARACTERISTICS $V_{SS} = 0\text{ V}$; $T_{amb} = 25\text{ °C}$; $C_L = 50\text{ pF}$; input transition times $\leq 20\text{ ns}$; see also waveforms Fig.5.

| | V_{DD} V | SYMBOL | MIN. | TYP. | MAX. | |
|---|---------------|-----------------|------|---------|---------------|------------------------------|
| Recovery time for \bar{C}_D | 5 | t_{RCD} | 0 | -75 | ns | to avoid change in output |
| | 10 | | 0 | -30 | ns | |
| | 15 | | 0 | -25 | ns | |
| Minimum \bar{I}_0 pulse width; LOW | 5 | t_{WI0L} | 50 | 25 | ns | |
| | 10 | | 30 | 15 | ns | |
| | 15 | | 20 | 10 | ns | |
| Minimum I_1 pulse width; HIGH | 5 | t_{WI1H} | 50 | 25 | ns | |
| | 10 | | 30 | 15 | ns | |
| | 15 | | 20 | 10 | ns | |
| Minimum \bar{C}_D pulse width; LOW | 5 | t_{WCDL} | 60 | 30 | ns | |
| | 10 | | 35 | 15 | ns | |
| | 15 | | 25 | 10 | ns | |
| Set-up time $\bar{C}_D \rightarrow \bar{I}_0$ or I_1 | 5 | t_{su} | 0 | -105 | ns | |
| | 10 | | 0 | -40 | ns | |
| | 15 | | 0 | -25 | ns | |
| Output O pulse width; HIGH | 5 | t_{WOH} | - | 235 | ns | note 1 |
| | 10 | | - | 155 | ns | |
| | 15 | | - | 140 | ns | |
| Output O pulse width; HIGH | 5 | t_{WOH} | - | 5,45 | μs | note 2 |
| | 10 | | - | 4,95 | μs | |
| | 15 | | - | 4,85 | μs | |
| Change in output O pulse width over temperature | 5 | Δt_{WO} | - | ± 3 | % | note 3 |
| | 10 | | - | ± 2 | % | |
| | 15 | | - | ± 2 | % | |
| Change in output O pulse width over V_{DD} | 5 | Δt_{WO} | - | ± 2 | % | $V_{DD} \pm 5\%$ |
| | 10 | | - | ± 1 | % | |
| | 15 | | - | ± 1 | % | |

Dual monostable multivibrator

HEF4528B
MSI

| | V _{DD} V | SYMBOL | MIN. | TYP. | MAX. | |
|---------------------------|----------------------|----------------|-----------|------|------|----|
| External timing resistor | 5 | R _t | 5 | – | 2000 | kΩ |
| | 10 | | 5 | – | 2000 | kΩ |
| | 15 | | 5 | – | 2000 | kΩ |
| External timing capacitor | 5 | C _t | no limits | | | |
| | 10 | | no limits | | | |
| | 15 | | no limits | | | |

Notes

- R_t = 5 kΩ; C_t = 15 pF; for other R_t, C_t combinations and C_t < 0,01 μF see graph Fig.4.
- R_t = 10 kΩ; C_t = 1000 pF; for other R_t, C_t combinations and C_t > 0,01 μF use formula $t_{WO} = K \cdot R_t \cdot C_t$.
 where: t_{WO} = output pulse width (s)
 R_t = external timing resistor (Ω)
 C_t = external timing capacitor (F)
 K = 0,42 for V_{DD} = 5 V
 K = 0,32 for V_{DD} = 10 V
 K = 0,30 for V_{DD} = 15 V
- T_{amb} = –40 to +85 °C; Δt_{WO} is referenced to t_{WO} at T_{amb} = 25 °C.

Dual monostable multivibrator

HEF4528B
MSI

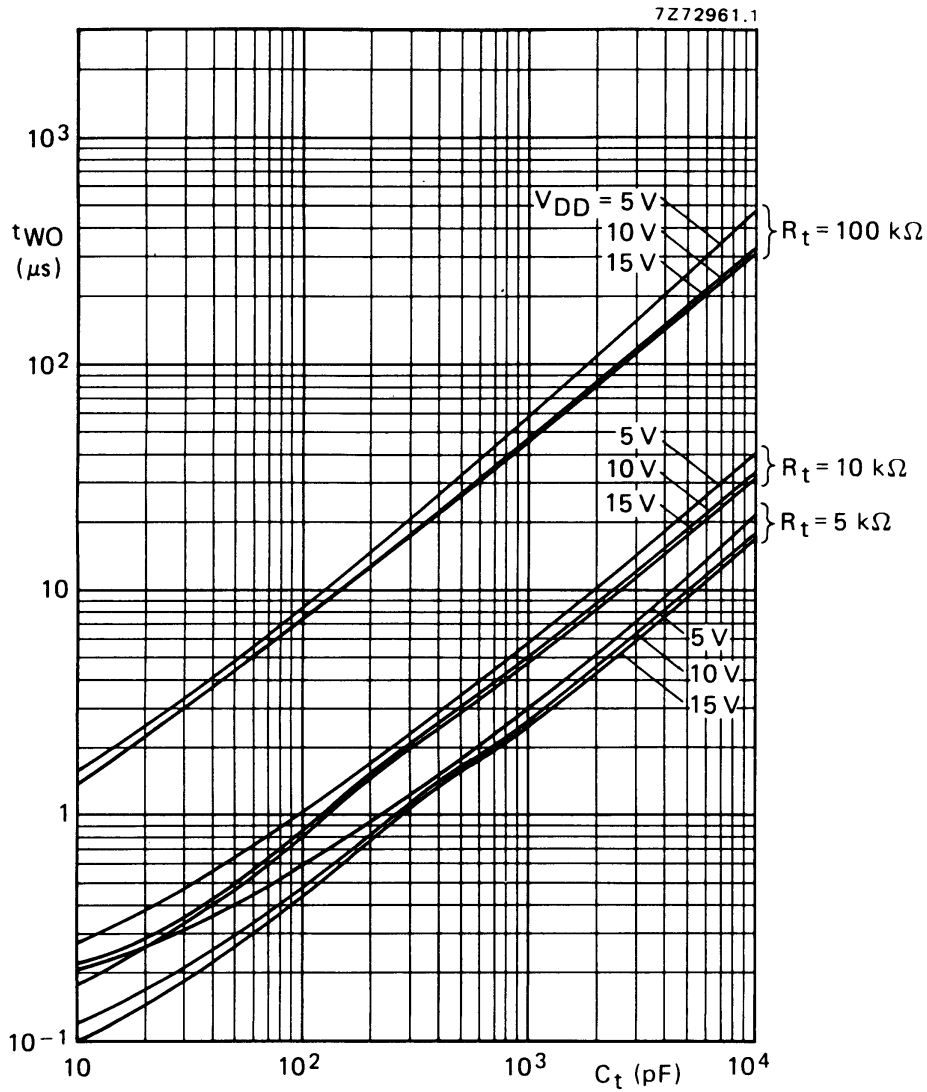

Fig.4 Output pulse width (t_{WO}) as a function of external timing capacitor (C_t).

Dual monostable multivibrator

HEF4528B
MSI

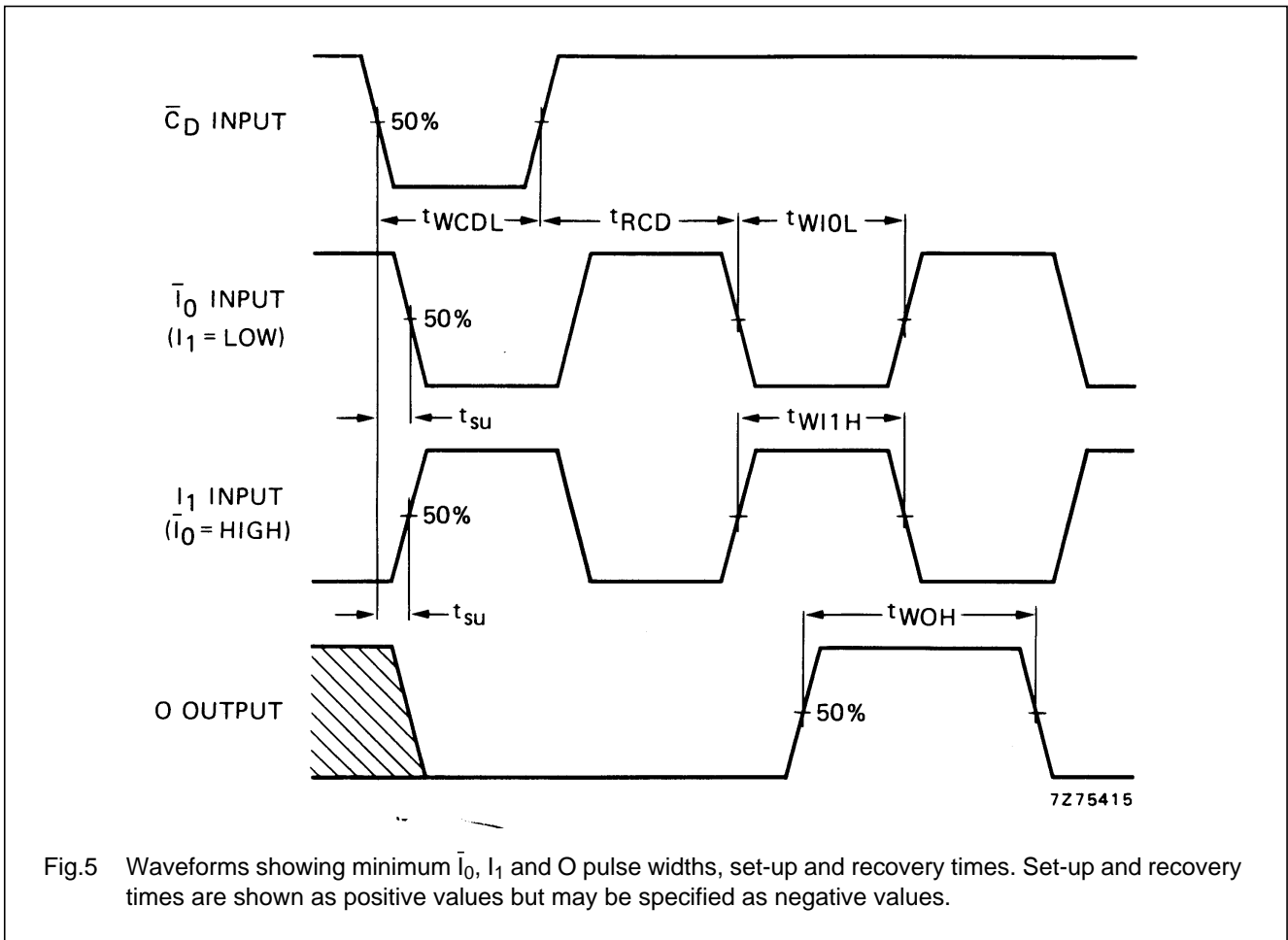

Fig.5 Waveforms showing minimum \bar{I}_0 , I_1 and O pulse widths, set-up and recovery times. Set-up and recovery times are shown as positive values but may be specified as negative values.

APPLICATION INFORMATION

An example of an application for the HEF4528B is:

- Non-retriggerable monostable multivibrator

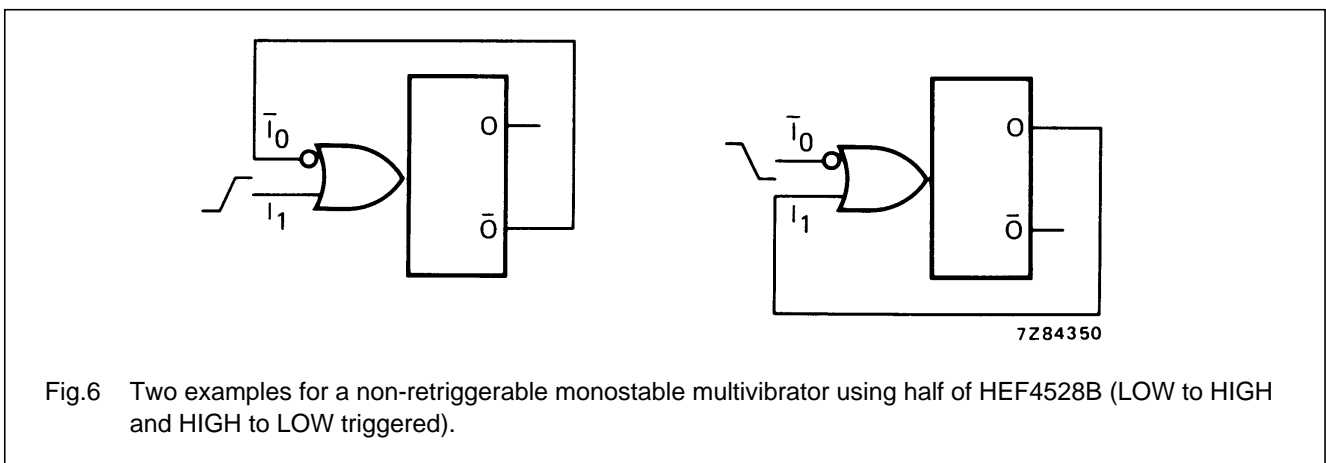

Fig.6 Two examples for a non-retriggerable monostable multivibrator using half of HEF4528B (LOW to HIGH and HIGH to LOW triggered).