



Features

- Lead free as standard
- RoHS compliant*
- Leadless
- High speed



CD1206-S0180 & S0180R are currently available, although not recommended for new designs. CD1206-S01575, CD1005-S0180 and CD1005-S0180R are preferred.

Switching Chip Diode Series - 1206

General Information

The markets of portable communications, computing and video equipment are challenging the semiconductor industry to develop increasingly smaller electronic components.

Bourns offers small-signal high-speed Switching Diodes for switching digital signal applications, in compact chip package 1206 size format, which offers PCB real estate savings and are considerably smaller than competitive parts. The Switching Diodes offer a forward current of 100 mA, a reverse voltage of 80 V and also have a low leakage reverse current option. The diodes are lead-free with Cu/Ni/Au plated terminations and are compatible with lead-free manufacturing processes, conforming to many industry and government regulations on lead-free components.

Bourns® Chip Diodes conform to JEDEC standards, are easy to handle on standard pick and place equipment and their flat configuration minimizes roll away.

Electrical Characteristics (@ T_A = 25 °C Unless Otherwise Noted)

Parameter	Symbol	CD1206-S0180	CD1206-S0180R	Unit
Forward Voltage (Max.)	V _F	1.00 (I _f = 100 mA)	1.00 (I _f = 100 mA)	V
Capacitance Between Terminals (Max.)	C _T	3 (f = 100 MHz, V _r = 1 V DC)		pF
Reverse Recovery Time (Max.)	t _{rr}	4 (V _r = 6V, I _f = 10 mA, R _L = 50 Ω)		nS
Reverse Current (Max.)	I _R	0.1 (V _r = 80 V)	0.05 (V _r = 75 V)	μA

Absolute Ratings (@ T_A = 25 °C Unless Otherwise Noted)

Parameter	Symbol	CD1206-S0180	CD1206-S0180R	Unit
Repetitive Peak Reverse Voltage	V _{RRM}	90	90	V
Reverse Voltage	V _R	80	80	V
Average Forward Current	I _o	100	100	mA
Forward Current, Surge Peak	I _{surge}	1*	1*	A
Power Dissipation	PD	300	300	mW
Storage Temperature	T _{STG}	-55 to +125		°C
Junction Temperature	T _J	-55 to +125		°C

* Condition: 8.3 ms single half sine-wave superimposed on rate load (JEDEC method).

How To Order

	CD 1206 - S 01 80 R
Common Code _____ Chip Diode	
Package _____ • 1206	
Model _____ S = High Speed Switching	
Average Forward Current (I _o) Code _____ 01 = 100 mA (Code x 1000 mA = Average Forward Current)	
Reverse Voltage (V _R) Code _____ 80 = 80 V	
Reverse Current Suffix _____ R = Low Leakage I _R (CD1206-S0180R)	

*RoHS Directive 2002/95/EC Jan 27 2003 including Annex Specifications are subject to change without notice. Customers should verify actual device performance in their specific applications.

Switching Chip Diode Series - 1206

BOURNS®

Product Dimensions

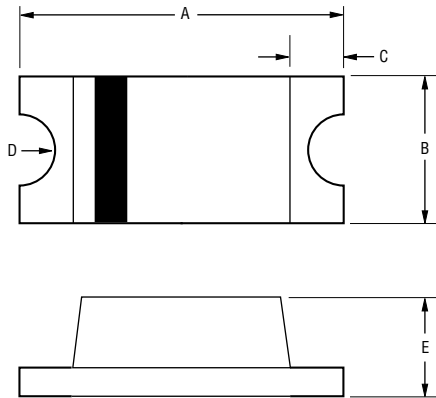

Dimension	1206
A	$\frac{3.00 - 3.20}{(0.118 - 0.126)}$
B	$\frac{1.40 - 1.60}{(0.055 - 0.063)}$
C	$\frac{0.50}{(0.020)}$ Typ.
D	$\frac{0.25}{(0.010)}$ R Typ.
E	$\frac{0.90 - 1.10}{(0.035 - 0.043)}$

DIMENSIONS: $\frac{\text{MM}}{\text{(INCHES)}}$

Recommended Pad Layout

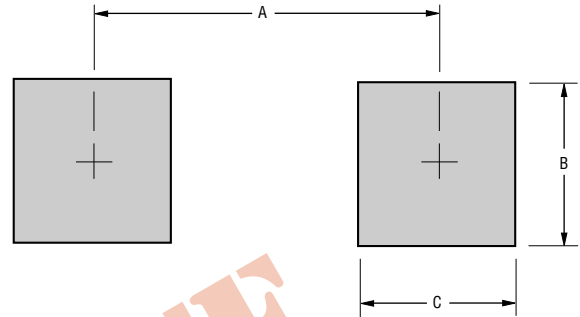

Dimension	1206
A (Max.)	$\frac{3.00}{(0.118)}$
B (Min.)	$\frac{1.60}{(0.063)}$
C (Min.)	$\frac{1.40}{(0.055)}$

DIMENSIONS: $\frac{\text{MM}}{\text{(INCHES)}}$

Physical Specifications

Case1206 (3216) Molded plastic
 TerminalsSolder plated, solderable per MIL-STD-750,
 Method 2026
 PolarityIndicated by cathode band
 Mounting PositionAny

Typical Part Marking

CD1206-S0180S1
 CD1206-S0180RS2

Switching Chip Diode Series - 1206

BOURNS®

Rating and Characteristic Curves: CD1206-S0180

Forward Characteristics

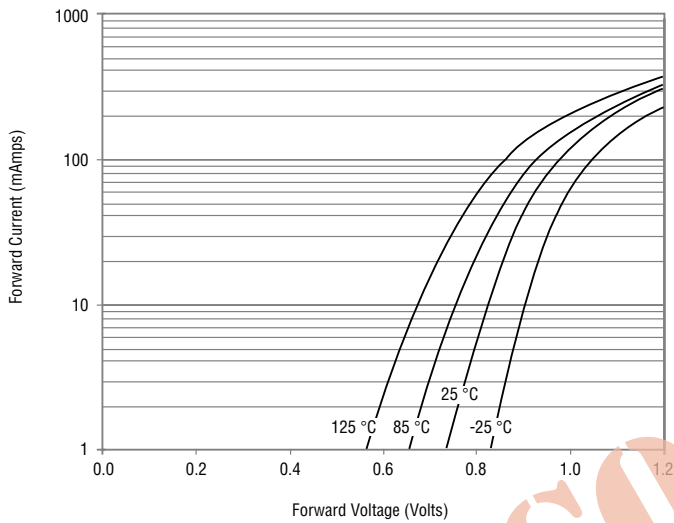

Reverse Characteristics

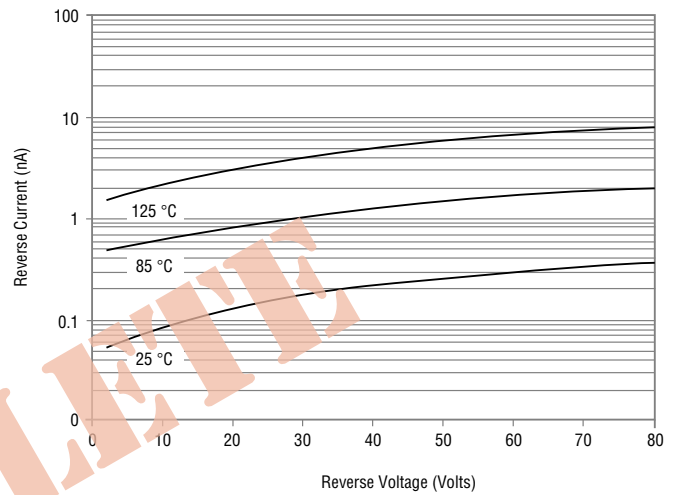

Derating Curve

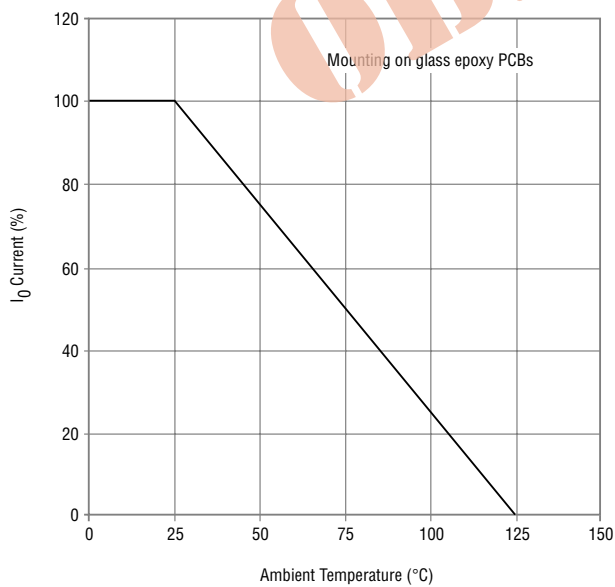

Capacitance Between Terminals

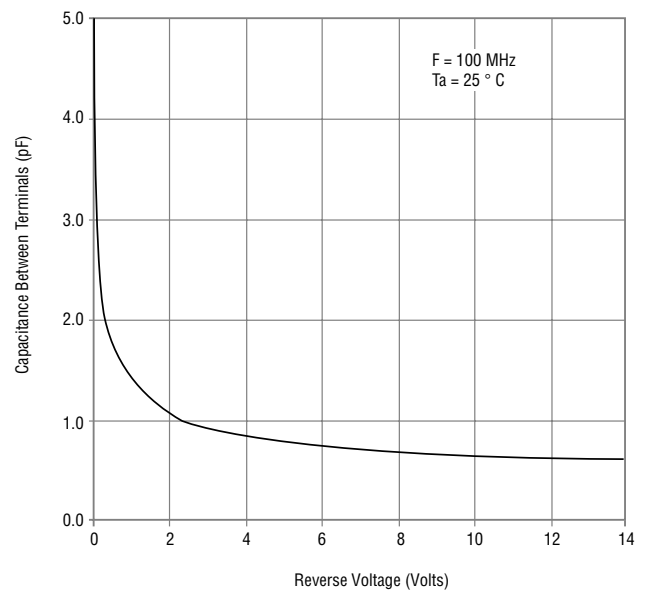

Switching Chip Diode Series - 1206

BOURNS®

Rating and Characteristic Curves: CD1206-S0180R

Forward Characteristics

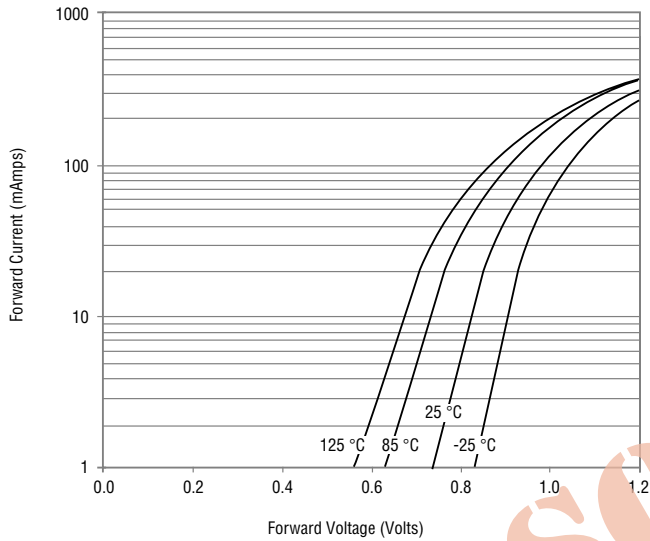

Reverse Characteristics

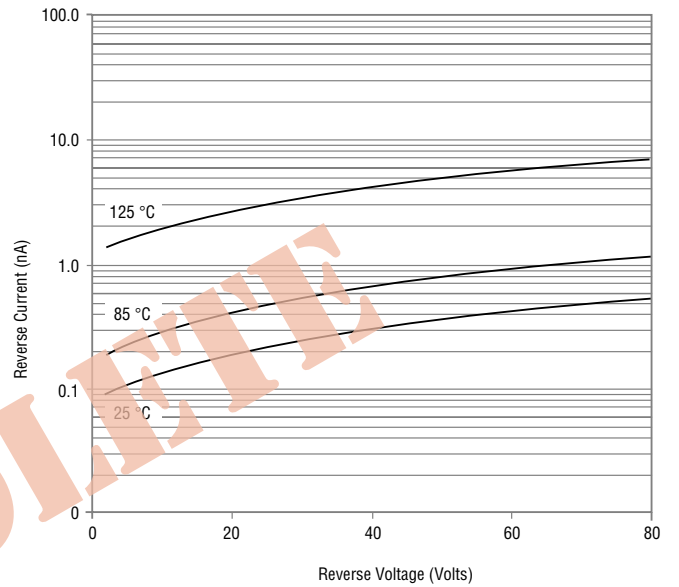

Derating Curve

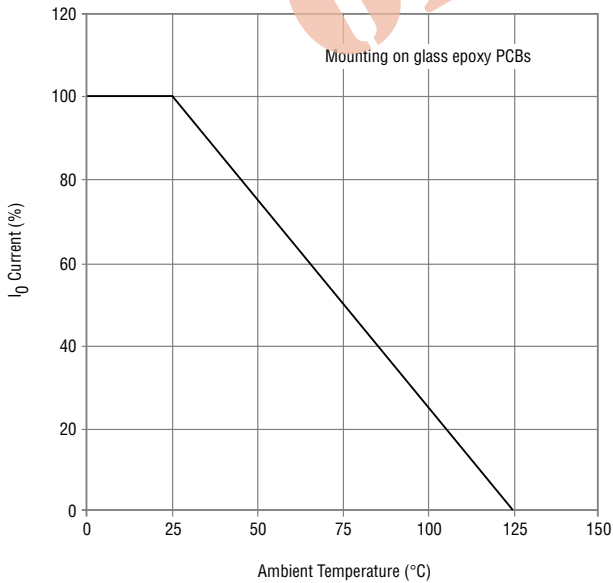

Capacitance Between Terminals

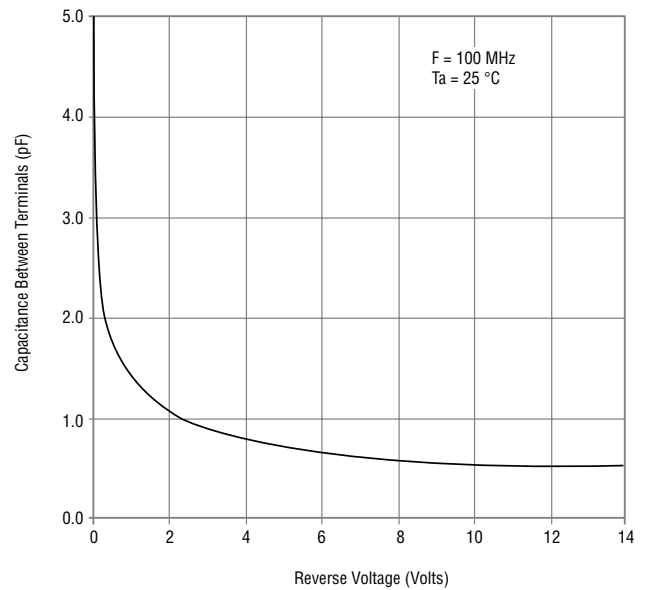

Switching Chip Diode Series - 1206

BOURNS®

Packaging Information

The product will be dispensed in Tape and Reel format (see diagram below).

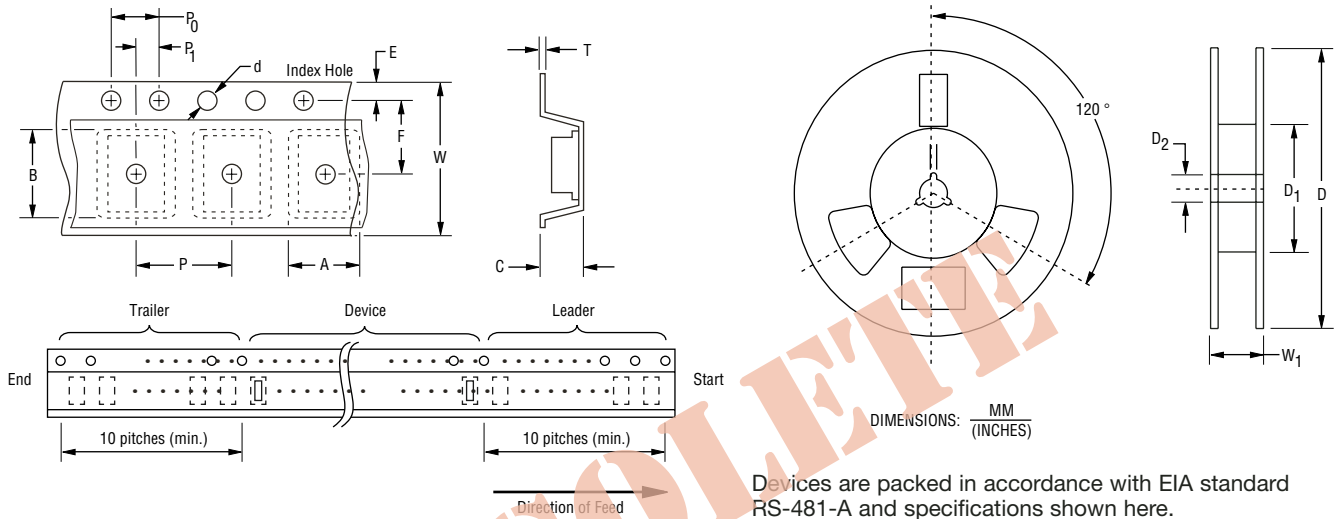

Devices are packed in accordance with EIA standard RS-481-A and specifications shown here.

Item	Symbol	1206
Carrier Width	A	1.70 ± 0.10 (0.067 - 0.004)
Carrier Length	B	3.40 ± 0.10 (0.134 - 0.004)
Carrier Depth	C	1.25 ± 0.10 (0.049 - 0.004)
Sprocket Hole	d	1.55 ± 0.10 (0.061 - 0.004)
Reel Outside Diameter	D	178 (7.008)
Reel Inner Diameter	D ₁	60.0 (2.362) MIN.
Feed Hole Diameter	D ₂	13.0 ± 0.20 (0.512 - 0.008)
Sprocket Hole Position	E	1.75 ± 0.10 (0.069 - 0.004)
Punch Hole Position	F	3.50 ± 0.05 (0.138 - 0.002)
Punch Hole Pitch	P	4.00 ± 0.10 (0.157 - 0.004)
Sprocket Hole Pitch	P ₀	4.00 ± 0.10 (0.157 - 0.004)
Embossment Center	P ₁	2.00 ± 0.05 (0.079 - 0.002)
Overall Tape Thickness	T	0.20 ± 0.05 (0.008 - 0.002)
Tape Width	W	8.00 ± 0.20 (0.315 - 0.008)
Reel Width	W ₁	13.5 (0.531) MAX.
Quantity per Reel	--	3,000