

# LM3528

*LM3528 High Efficiency, Multi Display LED Driver with 128 Exponential Dimming Steps and Integrated OLED Power Supply in a 1.2mm - 1.6mm SMD Package*



Literature Number: SNVS513

# LM3528

## High Efficiency, Multi Display LED Driver with 128 Exponential Dimming Steps and Integrated OLED Power Supply in a 1.2mm x 1.6mm $\mu$ SMD Package

### General Description

The LM3528 current mode boost converter offers two separate outputs. The first output (MAIN) is a constant current sink for driving series white LED's. The second output (SUB/FB) is configurable as a constant current sink for series white LED bias, or as a feedback pin to set a constant output voltage for powering OLED panels.

As a dual output white LED bias supply, the LM3528 adaptively regulates the supply voltage of the LED strings to maximize efficiency and insure the current sinks remain in regulation. The maximum current per output is set via a single external low power resistor. An I<sup>2</sup>C compatible interface allows for independent adjustment of the LED current in either output from 0 to max current in 128 exponential steps. When configured as a white LED + OLED bias supply the LM3528 can independently and simultaneously drive a string of up to 6 white LED's and deliver a constant output voltage of up to 21V for OLED panels.

Output over-voltage protection shuts down the device if V<sub>OUT</sub> rises above 22V allowing for the use of small sized low voltage output capacitors. Other features include a dedicated general purpose I/O (GPIO) and a multi-function pin (HWEN/PGEN/GPIO) which can be configured as a 32 bit pattern generator, a hardware enable input, or as a GPIO. When configured as a pattern generator, an arbitrary pattern is programmed via the I<sup>2</sup>C compatible interface and output at HWEN/PGEN/GPIO for indicator LED flashing or for external logic control. The LM3528 is offered in a tiny 12-bump  $\mu$ SMD package and operates over the -40°C to +85°C temperature range.

### Features

- 128 Exponential Dimming Steps
- Programmable Auto-Dimming Function
- Up to 90% Efficient
- Low Profile 12 Bump  $\mu$ -SMD Package (1.2mm x 1.6mm x 0.6mm)
- Integrated OLED Display Power Supply and LED Driver
- Programmable Pattern Generator Output for LED Indicator Function
- Drives up to 12 LED's at 20mA
- Drives up to 5 LED's at 20mA and delivers 18V at 40mA
- 1% Accurate Current Matching Between Strings
- Internal Soft-Start Limits Inrush Current
- True Shutdown Isolation for LED's
- Wide 2.5V to 5.5V Input Voltage Range
- 22V Over-Voltage Protection
- 1.25MHz Fixed Frequency Operation
- Dedicated Programmable General Purpose I/O
- Active Low Hardware Reset

### Applications

- Dual Display LCD Backlighting for Portable Applications
- Large Format LCD Backlighting
- OLED Panel Power Supply
- Display Backlighting with Indicator Light

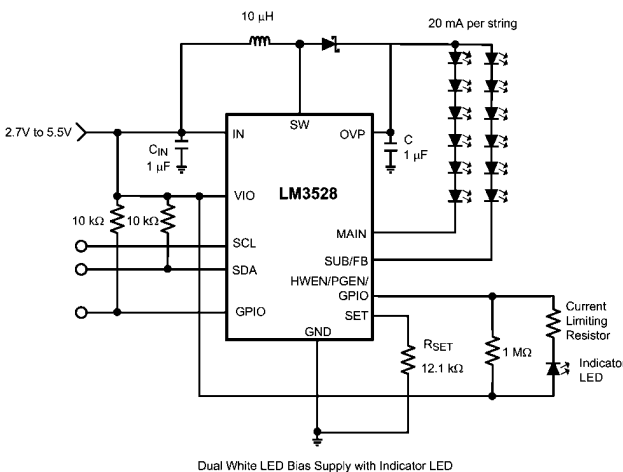

Typical Application Circuit

30020501

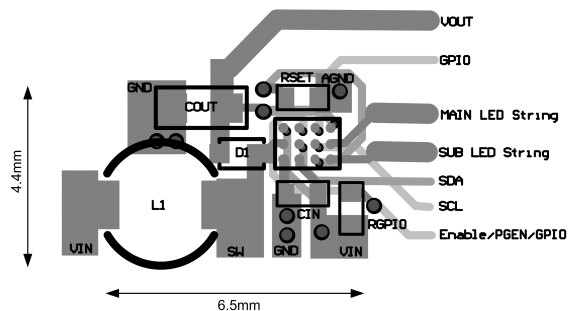

Typical PCB Layout

30020563

## Connection Diagram

### Top View

Top View

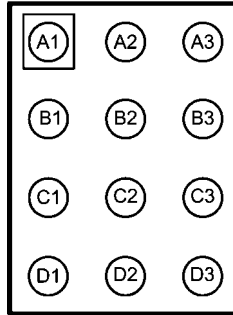

12-Bump (1.215mm × 1.615mm × 0.6mm) TMD12AAA <sup>30020502</sup>

## Ordering Information

Order Number	Package Type	NSC Package Drawing	Top Mark	Supplied As
LM3528TME	12-Bump $\mu$ SMD	TMD12AAA	SE	250 units, Tape-and-Reel, No Lead
LM3528TMX	12-Bump $\mu$ SMD	TMD12AAA	SE	3000 units, Tape-and-Reel, No Lead

## Pin Descriptions/Functions

Pin	Name	Function
A1	OVP	Over-Voltage Protection Sense Connection. Connect OVP to the positive terminal of the output capacitor.
A2	MAIN	Main Current Sink Input.
A3	SUB/FB	Secondary Current Sink Input or 1.21V Feedback Connection for Constant Voltage Output.
B1	GPIO1	Programmable General Purpose I/O.
B2	SCL	Serial Clock Input
B3	SET	LED Current Setting Connection. Connect a resistor from SET to GND to set the maximum LED current into MAIN or SUB/FB (when in LED mode), where $I_{LED\_MAX} = 192 \times 1.244V / R_{SET}$ .
C1	HWEN/PGEN/ GPIO	Active High Hardware Enable Input. Programmable Pattern Generator Output, and Programmable General Purpose I/O.
C2	SDA	Serial Data Input/Output
C3	IN	Input Voltage Connection. Connect IN to the input supply, and bypass to GND with a 1 $\mu$ F ceramic capacitor.
D1	VIO	Logic Voltage Level Input
D2	SW	Drain Connection for Internal NMOS Switch
D3	GND	Ground

## Absolute Maximum Ratings (Notes 1, 2)

If Military/Aerospace specified devices are required, please contact the National Semiconductor Sales Office/Distributors for availability and specifications.

$V_{IN}$	-0.3V to 6V
$V_{SW}$ , $V_{OVP}$ ,	-0.3V to 25V
$V_{SUB/FB}$ , $V_{MAIN}$	-0.3V to 23V
$V_{SCL}$ , $V_{SDA}$ , $V_{\overline{RESET}/GPIO}$ , $V_{IO}$ , $V_{SET}$	-0.3V to 6V
Continuous Power Dissipation	Internally Limited
Junction Temperature ( $T_{J-MAX}$ )	+150°C
Storage Temperature Range	-65°C to +150°C
Maximum Lead Temperature (Soldering, 10s)(Note 3)	+300°C
ESD Rating(Note 10) Human Body Model	2.5kV

## Operating Ratings (Notes 1, 2)

$V_{IN}$	2.5V to 5.5V
$V_{SW}$ , $V_{OVP}$ ,	0V to 23V
$V_{SUB/FB}$ , $V_{MAIN}$	0V to 21V
Junction Temperature Range ( $T_J$ )(Note 4)	-40°C to +110°C
Ambient Temperature Range ( $T_A$ )(Note 5)	-40°C to +85°C

## Thermal Properties

Junction to Ambient Thermal Resistance ( $\theta_{JA}$ )(Note 6)	68°C/W
---	--------

## ESD Caution Notice

National Semiconductor recommends that all integrated circuits be handled with appropriate ESD precautions. Failure to observe proper ESD handling techniques can result in damage to the device.

## Electrical Characteristics

Specifications in standard type face are for  $T_A = 25^\circ\text{C}$  and those in **boldface type** apply over the Operating Temperature Range of  $T_A = -40^\circ\text{C}$  to  $+85^\circ\text{C}$ . Unless otherwise specified  $V_{IN} = 3.6\text{V}$ ,  $V_{IO} = 1.8\text{V}$ ,  $V_{\overline{RESET}/GPIO} = V_{IN}$ ,  $V_{SUB/FB} = V_{MAIN} = 0.5\text{V}$ ,  $R_{SET} = 12.0\text{k}\Omega$ ,  $OLED = '0'$ ,  $ENM = ENS = '1'$ ,  $BSUB = BMAIN = \text{Full Scale}$ .(Notes 2, 7)

Symbol	Parameter	Conditions	Min	Typ	Max	Units
$I_{LED}$	Output Current Regulation MAIN or SUB/FB Enabled	UNI = '0', or '1', $2.5\text{V} < V_{IN} < 5.5\text{V}$	<b>18.5</b>	20	<b>22</b>	mA
	Maximum Current Per Current Sink	$R_{SET} = 8.0\text{k}\Omega$		30		
$I_{LED-MATCH}$	$I_{MAIN}$ to $I_{SUB/FB}$ Current Matching	UNI = '1', $2.5\text{V} < V_{IN} < 5.5\text{V}$ (Note 11)		0.15	<b>1</b>	%
$V_{SET}$	SET Pin Voltage	$3.0\text{V} < V_{IN} < 5\text{V}$		1.244		V
$I_{LED}/I_{SET}$	$I_{LED}$ Current to $I_{SET}$ Current Ratio			192		
$V_{REG\_CS}$	Regulated Current Sink Headroom Voltage			500		mV
$V_{REG\_OLED}$	$V_{SUB/FB}$ Regulation Voltage in OLED Mode	$2.5\text{V} < V_{IN} < 5.5\text{V}$ , $OLED = '1'$	<b>1.170</b>	1.21	<b>1.237</b>	V
$V_{HR}$	Current Sink Minimum Headroom Voltage	$I_{LED} = 95\%$ of nominal		300		mV
$R_{DSON}$	NMOS Switch On Resistance	$I_{SW} = 100\text{mA}$		0.43		$\Omega$
$I_{CL}$	NMOS Switch Current Limit	$2.5\text{V} < V_{IN} < 5.5\text{V}$	<b>645</b>	770	<b>900</b>	mA
$V_{OVP}$	Output Over-Voltage Protection	ON Threshold, $2.5\text{V} < V_{IN} < 5.5\text{V}$	<b>20.6</b>	22	<b>23</b>	V
		OFF Threshold, $2.7\text{V} < V_{IN} < 5.5\text{V}$	<b>19.25</b>	20.6	<b>21.5</b>	
$f_{SW}$	Switching Frequency		<b>1.0</b>	1.27	<b>1.4</b>	MHz
$D_{MAX}$	Maximum Duty Cycle			90		%
$D_{MIN}$	Minimum Duty Cycle			10		%

Symbol	Parameter	Conditions	Min	Typ	Max	Units
$I_Q$	Quiescent Current, Device Not Switching	$V_{MAIN}$ and $V_{SUB/FB} > V_{REG\_CS}$ , BSUB = BMAIN = 0x00, 2.5V $< V_{IN} < 5.5V$		350	390	$\mu A$
		$V_{SUB/FB} > V_{REG\_OLED}$ , OLED='1', ENM=ENS='0', R <sub>SET</sub> Open, 2.5V $< V_{IN} < 5.5V$		250	260	
$I_{SHDN}$	Shutdown Current	ENM = ENS = OLED = '0', 2.5V $< V_{IN} < 5.5V$		1.8	3	$\mu A$
<b>HWEN/PGEN/GPIO, GPIO1 Pin Voltage Specifications</b>						
$V_{IL}$	Input Logic Low	2.5V $< V_{IN} < 5.5V$ , MODE bit = 0			0.5	V
$V_{IH}$	Input Logic High	2.5V $< V_{IN} < 5.5V$ , MODE bit = 0	1.1			V
$V_{OL}$	Output Logic Low	$I_{LOAD}=3mA$ , MODE bit = 1			400	mV
<b>I<sup>2</sup>C Compatible Voltage Specifications (SCL, SDA, VIO)</b>						
$V_{IO}$	Serial Bus Voltage Level	2.5V $< V_{IN} < 5.5V$ (Note 9)	1.7		$V_{IN}$	V
$V_{IL}$	Input Logic Low	2.5V $< V_{IN} < 5.5V$			$0.36 \times V_{IO}$	V
$V_{IH}$	Input Logic High	2.5V $< V_{IN} < 5.5V$	$0.7 \times V_{IO}$			V
$V_{OL}$	Output Logic Low	$I_{LOAD} = 3mA$			400	mV
<b>I<sup>2</sup>C Compatible Timing Specifications (SCL, SDA, VIO, see Figure 1) (Notes 8, 9)</b>						
$t_1$	SCL Clock Period		2.5			$\mu s$
$t_2$	Data In Setup Time to SCL High		100			ns
$t_3$	Data Out Stable After SCL Low		0			ns
$t_4$	SDA Low Setup Time to SCL Low (Start)		100			ns
$t_5$	SDA High Hold Time After SCL High (Stop)		100			ns

**Note 1:** Absolute maximum ratings are limits beyond which damage to the device may occur. Operating Ratings are conditions for which the device is intended to be functional, but device parameter specifications may not be guaranteed. For guaranteed specifications and test conditions, see the Electrical Characteristics.

**Note 2:** All voltages are with respect to the potential at the GND pin.

**Note 3:** For detailed soldering specifications and information, please refer to National Semiconductor Application Note 1112: Micro SMD Wafer L<sup>E</sup>vel Chip Scale Package (AN-1112).

**Note 4:** Internal thermal shutdown circuitry protects the device from permanent damage. Thermal shutdown engages at  $T_J=+150^\circ C$  (typ.) and disengages at  $T_J=+140^\circ C$  (typ.).

**Note 5:** In applications where high power dissipation and/or poor package thermal resistance is present, the maximum ambient temperature may have to be derated. Maximum ambient temperature ( $T_{A-MAX}$ ) is dependent on the maximum operating junction temperature ( $T_{J-MAX-OP} = +105^\circ C$ ), the maximum power dissipation of the device in the application ( $P_{D-MAX}$ ), and the junction-to ambient thermal resistance of the part/package in the application ( $\theta_{JA}$ ), as given by the following equation:  $T_{A-MAX} = T_{J-MAX-OP} - (\theta_{JA} \times P_{D-MAX})$ .

**Note 6:** Junction-to-ambient thermal resistance ( $\theta_{JA}$ ) is taken from a thermal modeling result, performed under the conditions and guidelines set forth in the JEDEC standard JESD51-7. The test board is a 4-layer FR-4 board measuring 114.3mm x 76.2mm x 1.6mm. The ground plane on the board is 113mm x 75mm. Thickness of copper layers are 71.5 $\mu m$ /35 $\mu m$ /35 $\mu m$ /71.5 $\mu m$  (2oz/1oz/1oz/2oz). Ambient temperature in simulation is 22 $^\circ C$ , still air. Power dissipation is 1W. For more information on these topics, please refer to National Semiconductor Application Note 1112, and JEDEC Standard JESD51-7.

**Note 7:** Min and Max limits are guaranteed by design, test, or statistical analysis. Typical (Typ) numbers are not guaranteed, but represent the most likely norm.

**Note 8:** SCL and SDA must be glitch-free in order for proper brightness control to be realized.

**Note 9:** SCL and SDA signals are referenced to VIO and GND for minimum VIO voltage testing. VIO limits indicate the minimum voltage at VIO at which the part is operational.

**Note 10:** The human body model is a 100pF capacitor discharged through 1.5k $\Omega$  resistor into each pin. (MIL-STD-883 3015.7).

**Note 11:** The matching specification between MAIN and SUB is calculated as  $100 \times ((I_{MAIN} \text{ or } I_{SUB}) - I_{AVE}) / I_{AVE}$ . This simplifies out to be  $100 \times (I_{MAIN} - I_{SUB}) / (I_{MAIN} + I_{SUB})$ .

# Timing Diagram

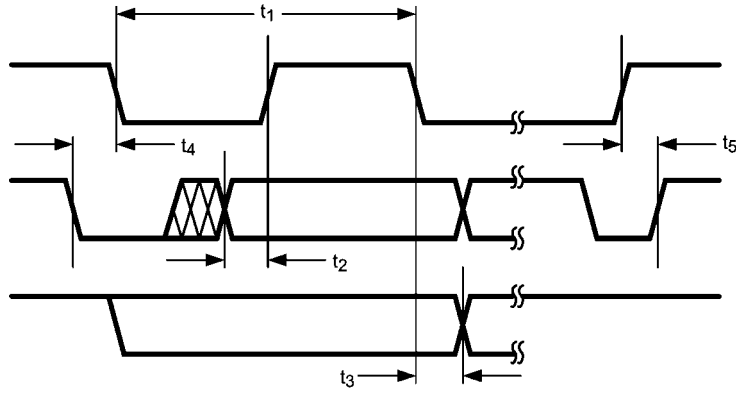

30020503

FIGURE 1. I<sup>2</sup>C Timing

**Typical Performance Characteristics**  $V_{IN} = 3.6V$ , LEDs are Nichia (NSSW008C),  $C_{OUT} = 1\mu F$  (LED Mode),  $C_{OUT} = 2.2\mu F$  (OLED Mode),  $C_{IN} = 1\mu F$ ,  $L = TDK VLF4012AT-100MR79$ , ( $R_L = 0.3\Omega$ ),  $R_{SET} = 12.1k\Omega$ ,  $UNI = '1'$ ,  $I_{LED} = I_{SUB} + I_{MAIN}$ ,  $T_A = +25^\circ C$  unless otherwise specified.

**2x6 LED Efficiency vs  $I_{LED}$**   
(2 Strings of 6LEDs)

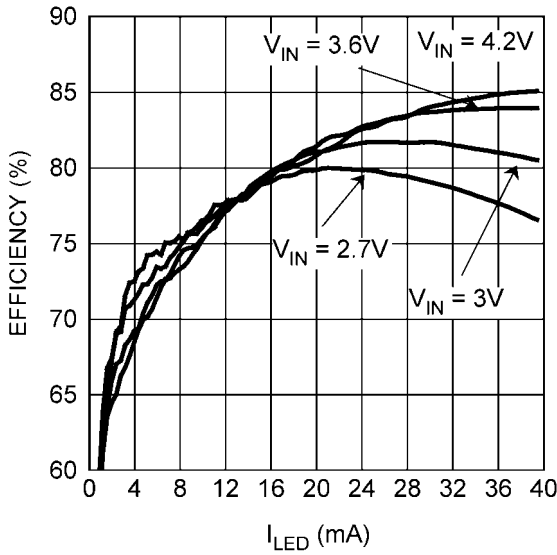

**2x5 LED Efficiency vs  $I_{LED}$**   
(2 Strings of 5LEDs)

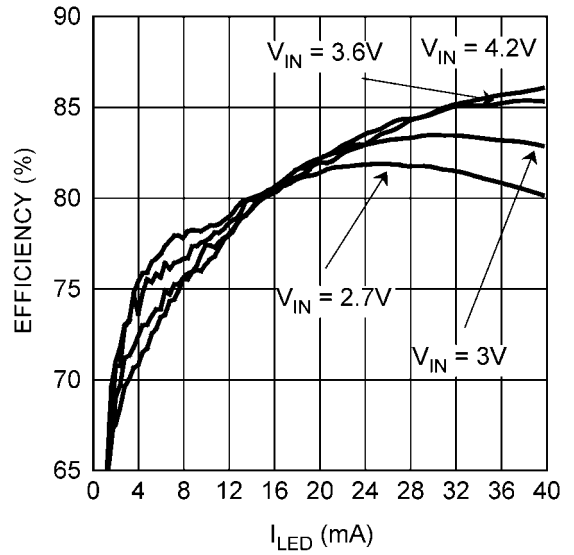

**2x4 LED Efficiency vs  $I_{LED}$**   
(2 Strings of 4LEDs)

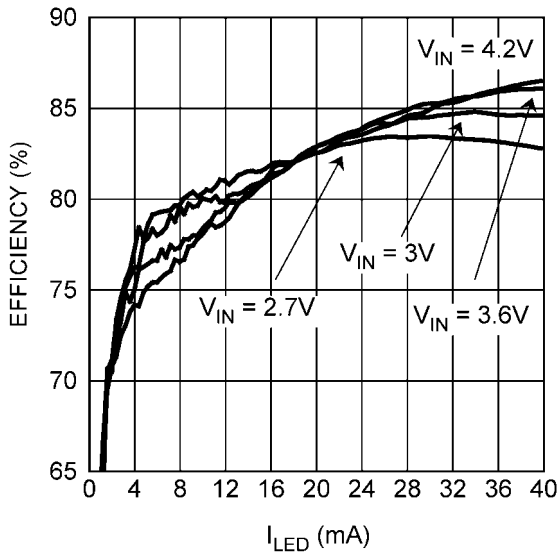

**2x3 LED Efficiency vs  $I_{LED}$**   
(2 Strings of 3LEDs)

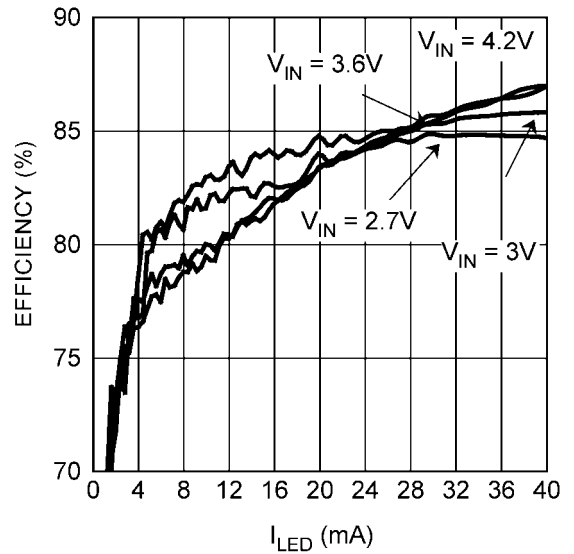

**2x2 LED Efficiency vs  $I_{LED}$**   
(2 Strings of 2LEDs)

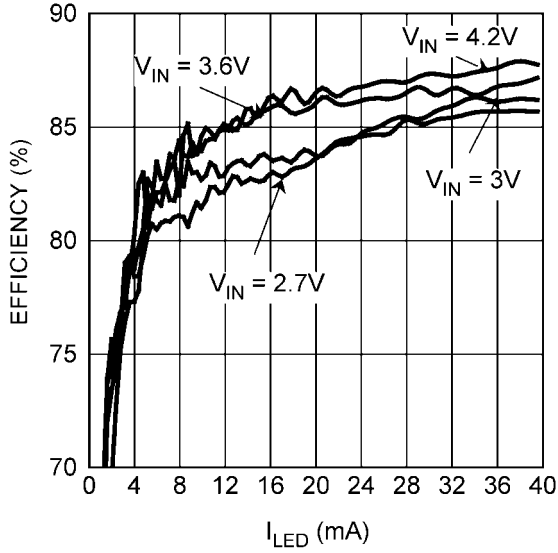

30020512

**LED Efficiency vs  $V_{IN}$**   
( $L = \text{TDK VLF3012AT-100MR92}$ ,  $R_L = 0.36\Omega$ ,  $I_{SUB} + I_{MAIN} = 40\text{mA}$ )

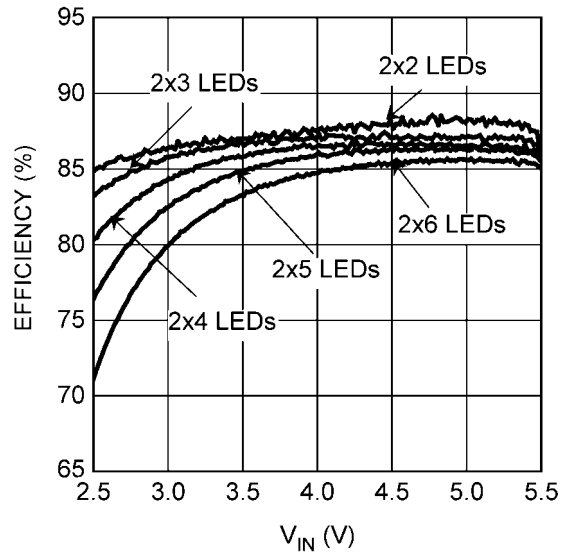

30020513

**18V OLED Efficiency vs  $I_{OUT}$**

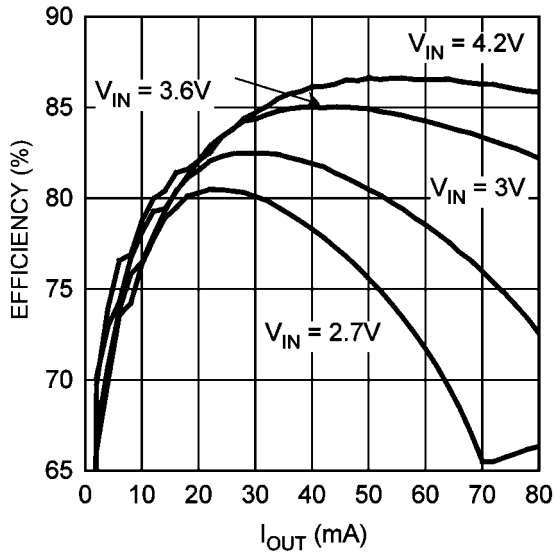

30020514

**12V OLED Efficiency vs  $I_{OUT}$**

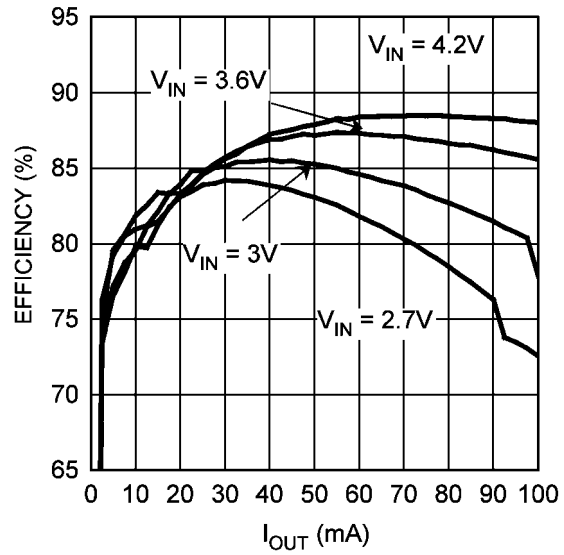

30020515



**LED Line Regulation**  
(UNI = '0')

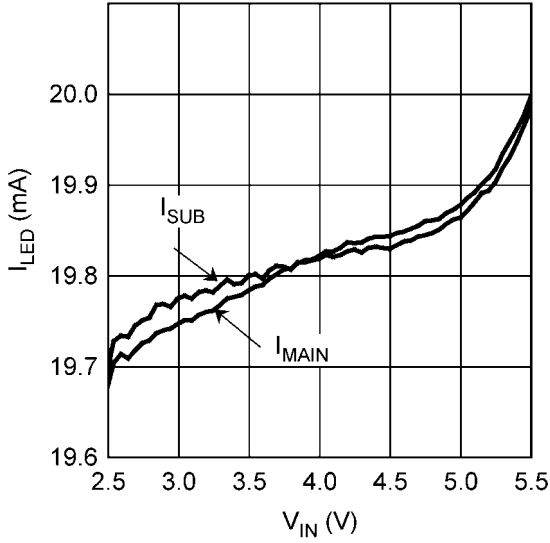

30020516

**OLED Line Regulation**  
 $I_{OLED} = 60mA$

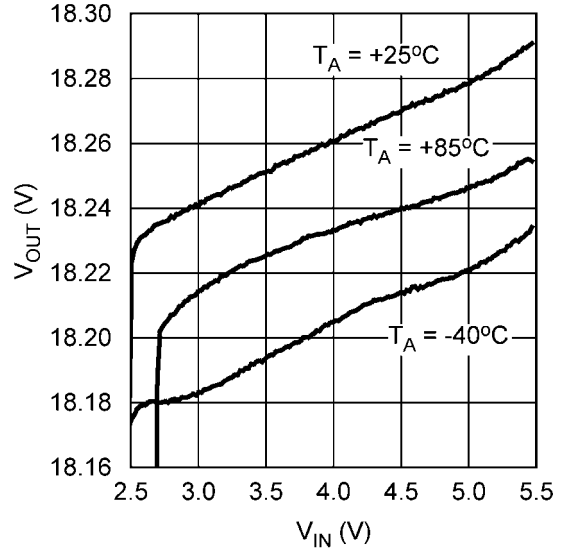

30020517

**OLED Line Regulation**  
 $I_{OLED} = 60mA$

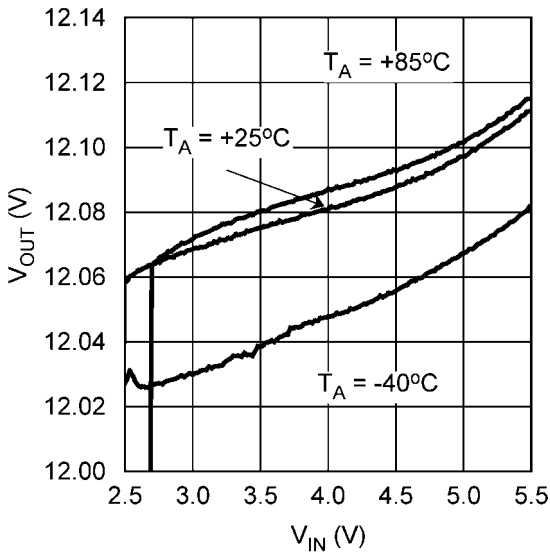

30020518

**OLED Load Regulation**  
 $V_{OLED} = 18V$

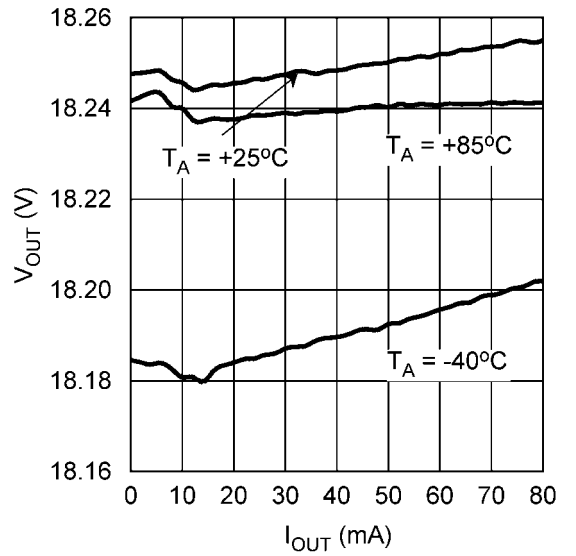

30020519

**OLED Load Regulation**  
 $V_{OLED} = 12V$

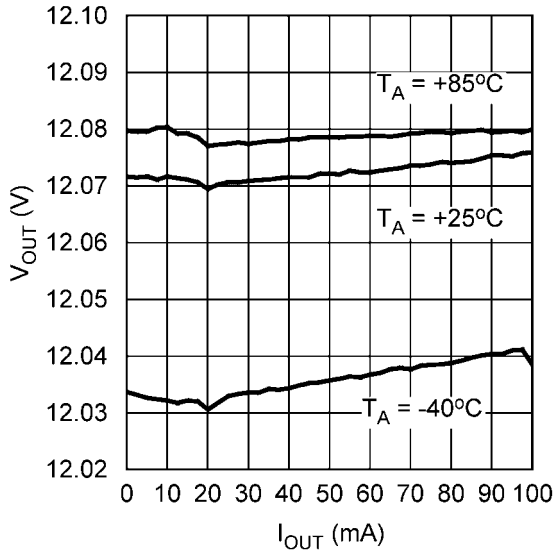

30020520

**Peak Current Limit vs.  $V_{IN}$**

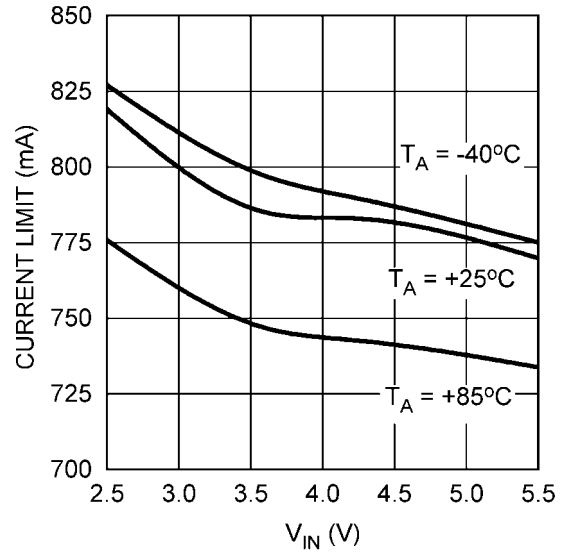

30020521

**Over Voltage Limit vs.  $V_{IN}$**

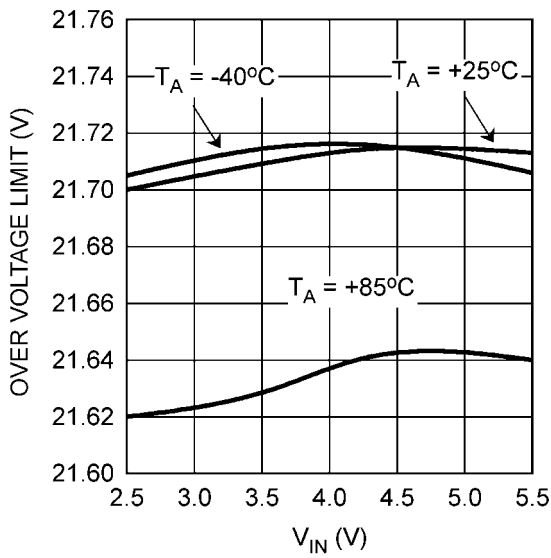

30020522

**Switch On-Resistance vs.  $V_{IN}$**

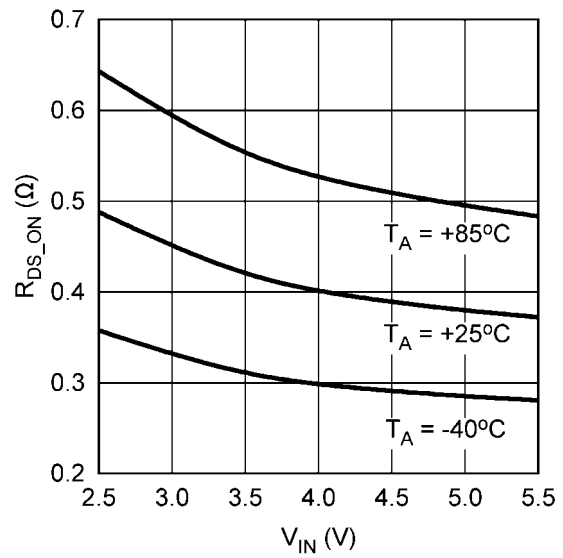

30020523

Switching Frequency vs.  $V_{IN}$

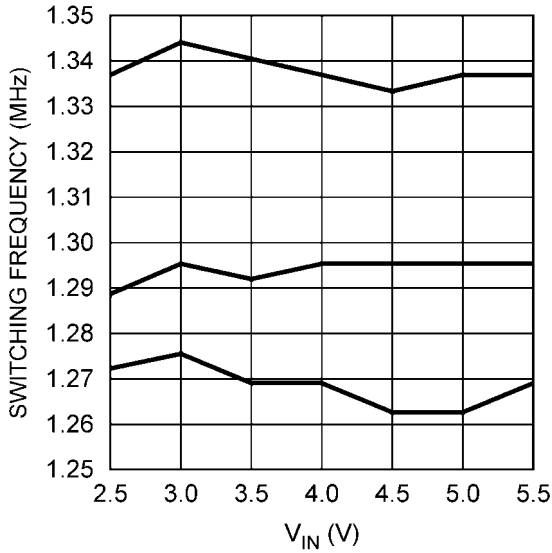

30020524

Maximum Duty Cycle vs.  $V_{IN}$

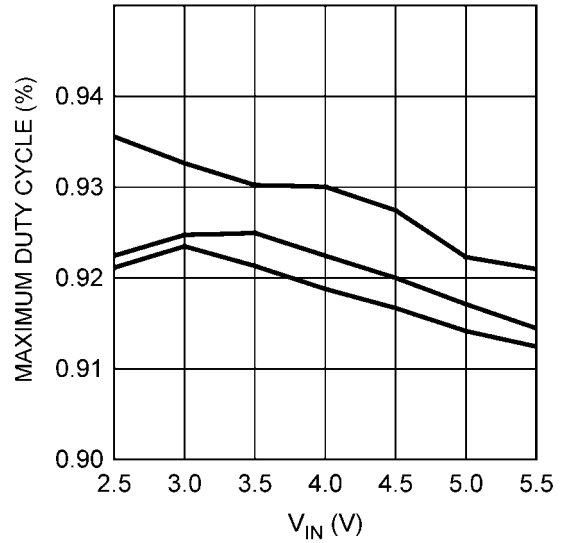

30020525

Shutdown Current vs.  $V_{IN}$

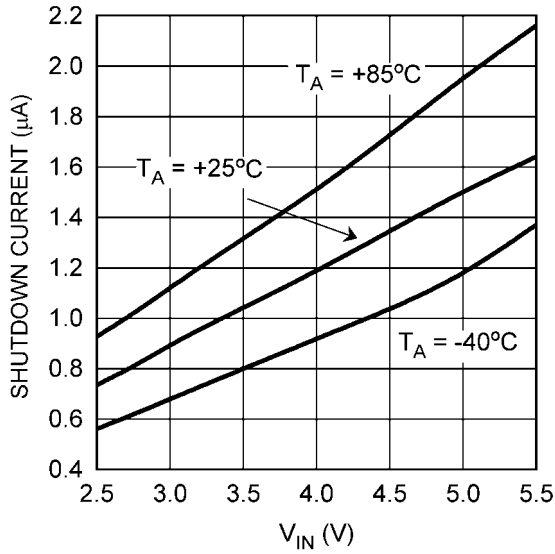

30020526

Switching Supply Current vs.  $V_{IN}$

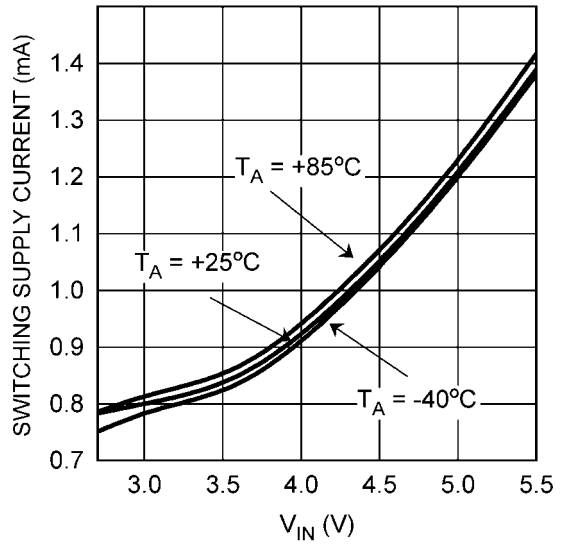

30020527

**LED Current Matching vs. CODE (Note 11)**  
 (UNI = '1',  $R_{SET} = 12k\Omega$ ,  $T_A = -40^\circ C$  to  $+85^\circ C$ )

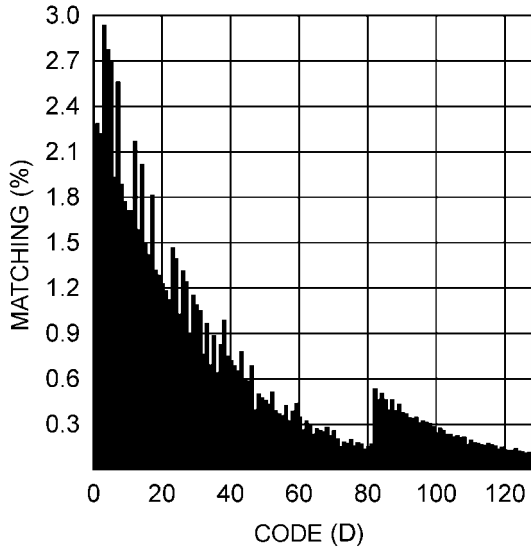

30020528

**LED Current Accuracy vs CODE**  
 ( $R_{SET} = 12k\Omega \pm 0.05\%$ )

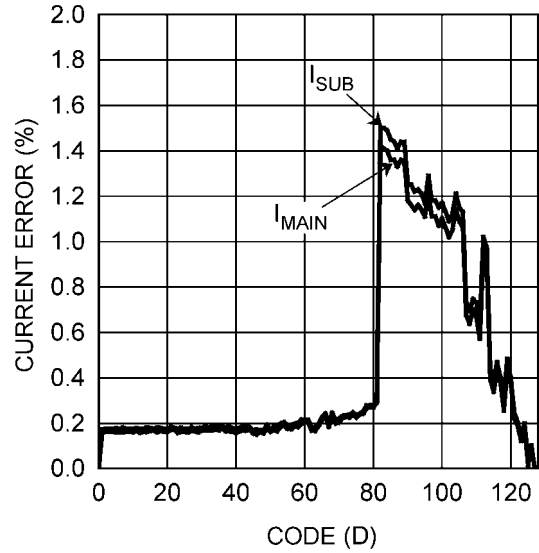

30020529

**LED Current vs CODE**  
 ( $I_{MAIN}$ ,  $I_{SUB}$ ,  $I_{IDEAL}$ ,  $R_{SET} = 12k\Omega \pm 0.05\%$ )

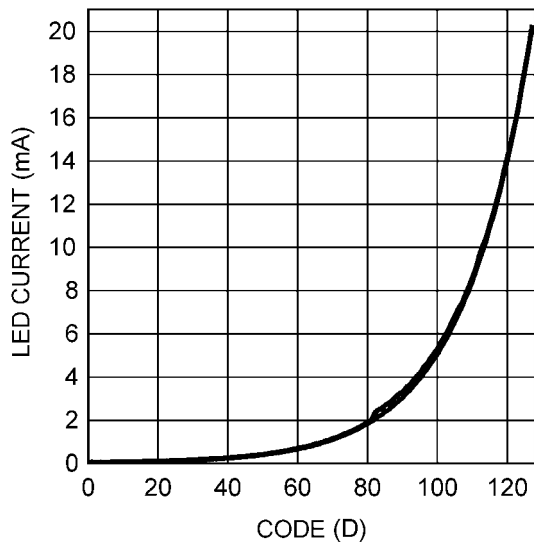

30020530

**$I_{LED}$  vs Current Source Headroom Voltage**  
 ( $V_{IN} = 3V$ , UNI = '0')

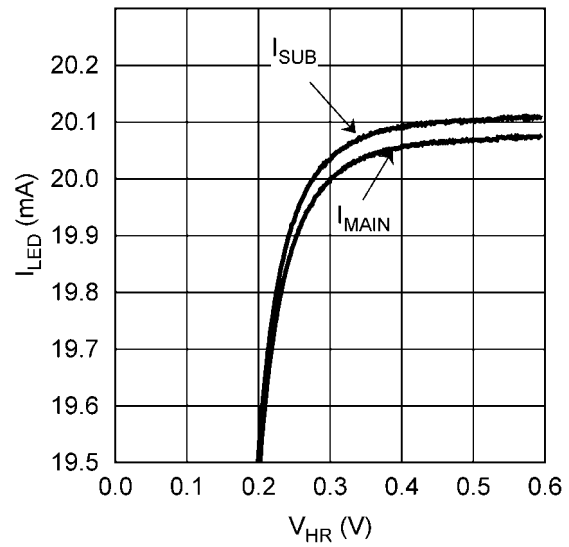

30020531

**Start-Up Waveform (LED Mode)**  
(2 x 5 LEDs, 20mA per string)

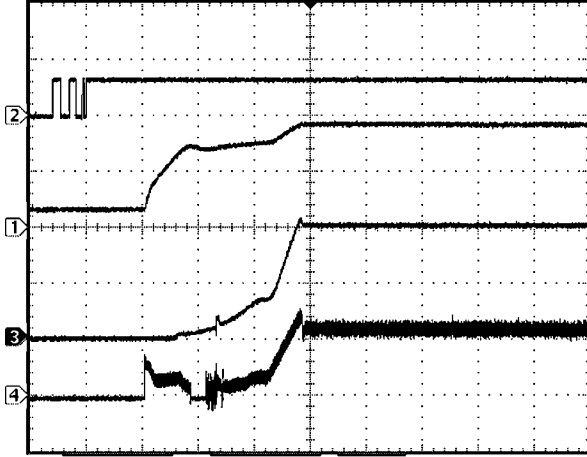

30020556

Channel 2: SDA (5V/div)  
Channel 1: V<sub>OUT</sub> (10V/div)  
Channel 3: I<sub>LED</sub> (20mA/div)  
Channel 4: I<sub>IN</sub> (200mA/div)  
Time Base: 400μs/div

**Start-Up Waveform (OLED Mode)**  
(V<sub>OUT</sub> = 18V, I<sub>OUT</sub> = 60mA)

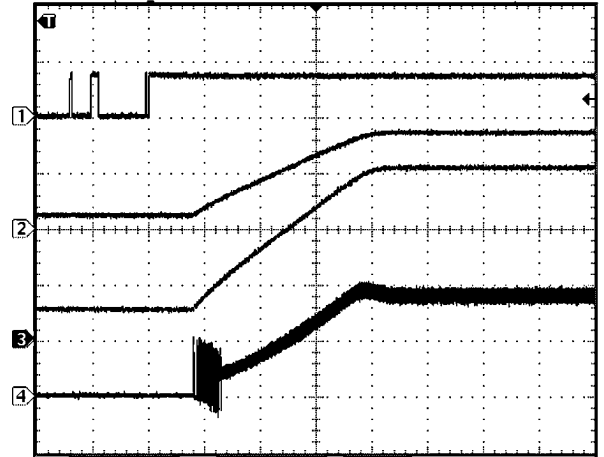

30020555

Channel 1: SDA (5V/div)  
Channel 2: V<sub>OUT</sub> (10V/div)  
Channel 3: I<sub>OUT</sub> (20mA/div)  
Channel 4: I<sub>IN</sub> (200mA/div)  
Time Base: 400μs/div

**Load Step (OLED Mode)**  
(V<sub>OUT</sub> = 18V, C<sub>OUT</sub> = 2.2μF)

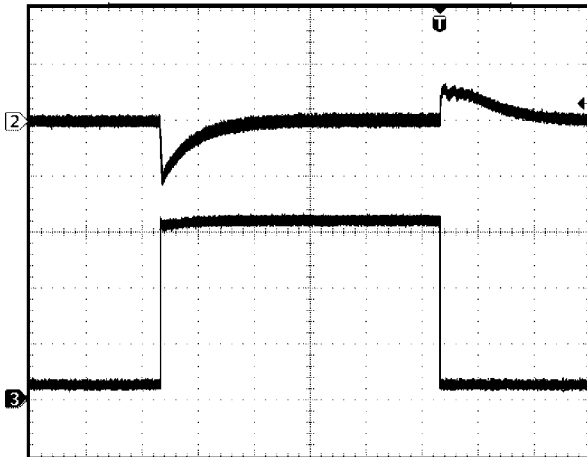

30020553

Channel 2: V<sub>OUT</sub> (AC Coupled, 500mV/div)  
Channel 3: I<sub>OUT</sub> (20mA/div)  
Time Base: 200μs/div

**Line Step (LED Mode)**  
(2 x 5 LEDs, 20mA per String, C<sub>OUT</sub> = 1μF, V<sub>IN</sub> from 3V to 3.6V)

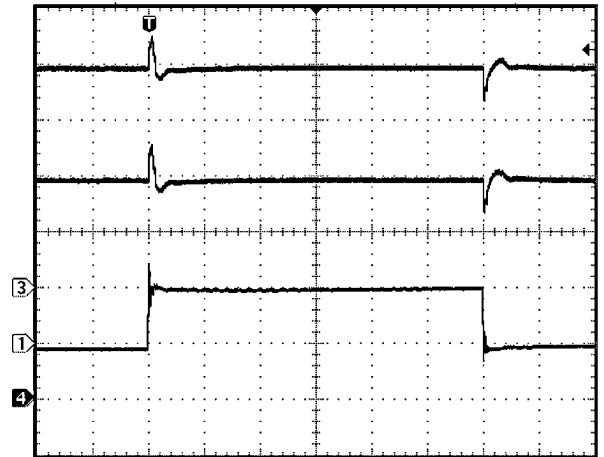

30020552

Channel 3: I<sub>SUB</sub> (5mA/div)  
Channel 4: I<sub>MAIN</sub> (5mA/div)  
Channel 2: V<sub>IN</sub> (AC Coupled, 500mV/div)  
Time Base: 100μs/div

**Line Step (OLED Mode)**  
 ( $V_{OUT} = 18V$ ,  $C_{OUT} = 2.2\mu F$ ,  $V_{IN}$  from 3V to 3.6V)

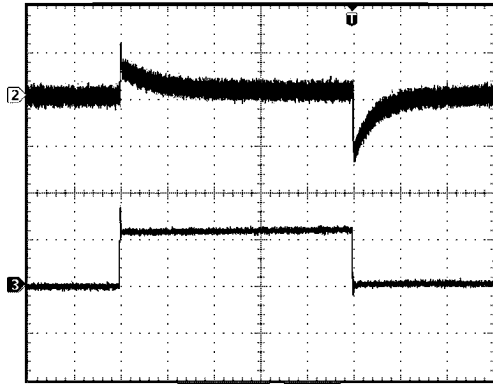

Channel 2: VOUT (AC Coupled, 100mV/div)  
 Channel 3: VIN (AC Coupled, 500mV/div)  
 Time Base: 200µs/div

30020557

**HWEN Functionality**

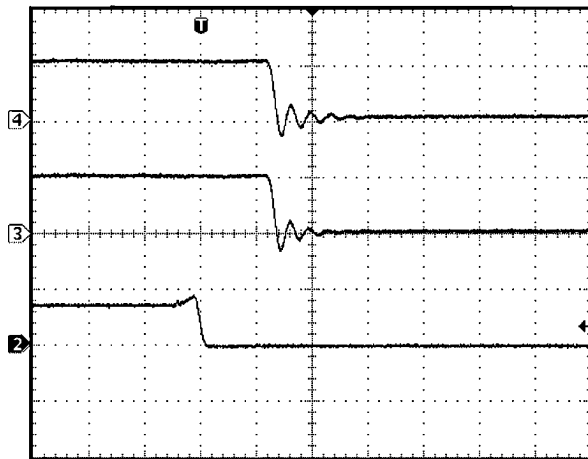

Channel 4:  $I_{SUB}$  (20mA/div)  
 Channel 3:  $I_{MAIN}$  (20mA/div)  
 Channel 2: HWEN (5V/div)  
 Time Base: 200ns/div

30020551

**GPIO1 Functionality**  
 (GPIO1 Configured as OUTPUT,  $f_{SCL} = 360kHz$ )

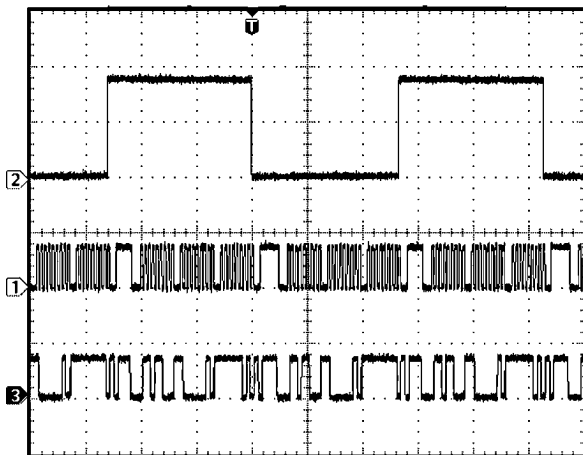

Channel 2: GPIO (2V/div)  
 Channel 1: SCL (5V/div)  
 Channel 1: SDA (5V/div)  
 Time Base: 40µs/div

30020558

**Ramp Rate Functionality**  
 (RMP1, RMP0 = '11')

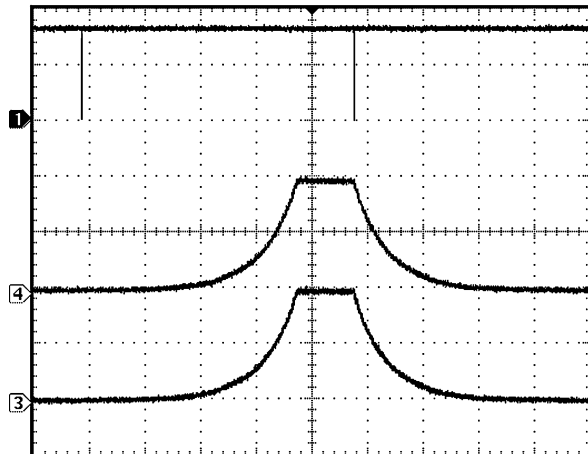

Channel 1: SDA (2V/div)  
 Channel 4:  $I_{SUB}$  (10mA/div)  
 Channel 3:  $I_{SUB}$  (10mA/div)  
 Time Base: 400ms/div

30020554

## Block Diagram

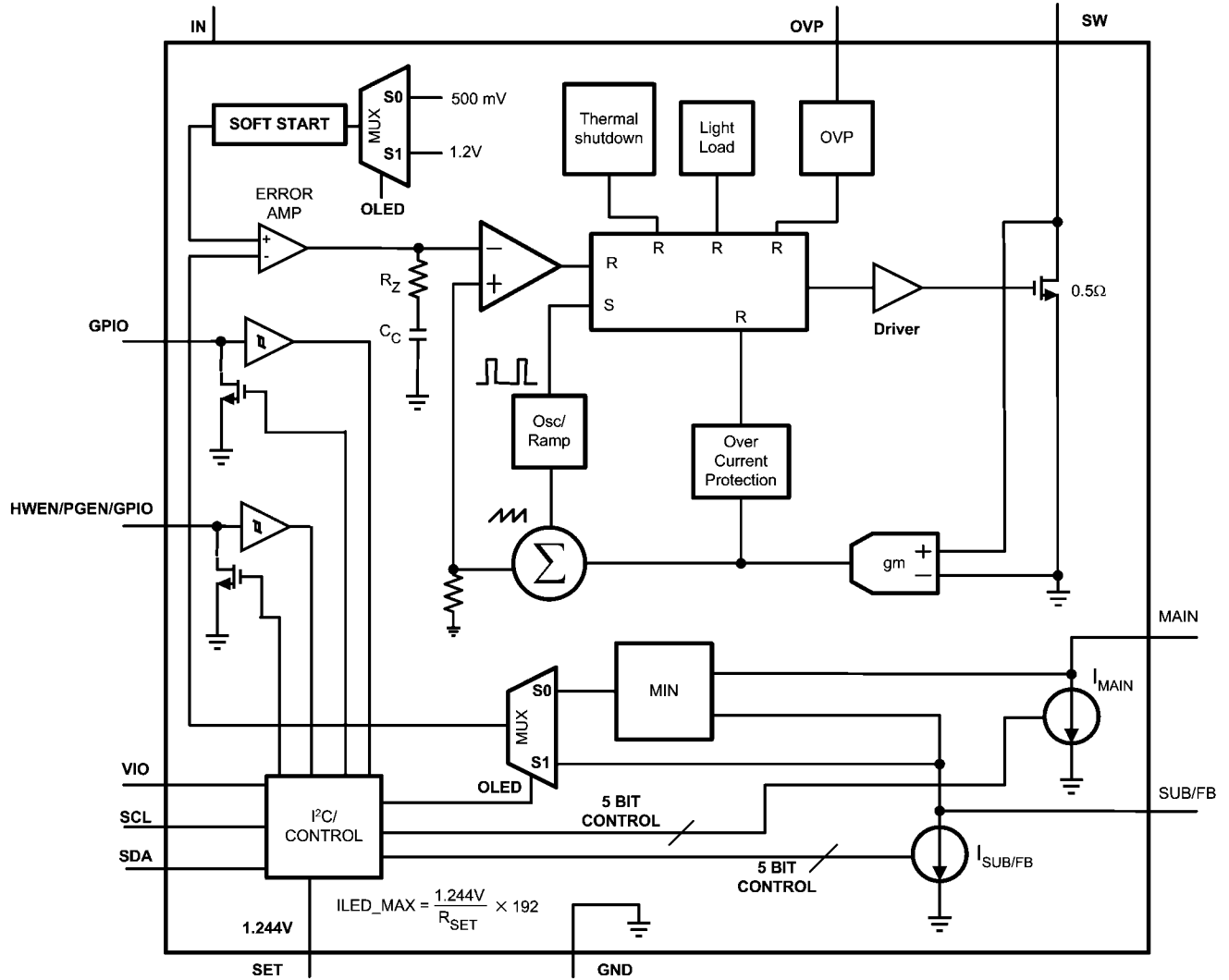

30020533

FIGURE 2. LM3528 Block Diagram

### Operation Description

The LM3528 Current Mode PWM boost converter operates from a 2.7V to 5.5V input and provides two regulated outputs for White LED and OLED display biasing. The first output, MAIN, provides a constant current of up to 30mA to bias up to 6 series white LED's. The second output, SUB/FB, can be configured as a current source for up to 6 series white LED's at up to 30mA, or as a feedback voltage pin to regulate a constant output voltage of up to 21V. When both MAIN and SUB/FB are configured for white LED bias the current for each LED string is controlled independently or in unison via an I<sup>2</sup>C compatible interface. When MAIN is configured for white LED bias and SUB/FB is configured as a feedback voltage pin, the current into MAIN is controlled via the I<sup>2</sup>C compatible interface and SUB/FB becomes the middle tap of a resistive divider used to regulate the output voltage of the boost converter.

The core of the LM3528 is a Current Mode Boost converter. Operation is as follows. At the start of each switching cycle the internal oscillator sets the PWM converter. The converter turns the NMOS switch on, allowing the inductor current to

ramp while the output capacitor supplies power to the white LED's and/or OLED panel. The error signal at the output of the error amplifier is compared against the sensed inductor current. When the sensed inductor current equals the error signal, or when the maximum duty cycle is reached, the NMOS switch turns off causing the external Schottky diode to pick up the inductor current. This allows the inductor current to ramp down causing its stored energy to charge the output capacitor and supply power to the load. At the end of the clock period the PWM controller is again set and the process repeats itself.

### ADAPTIVE REGULATION

When biasing dual white led strings (White LED mode) the LM3528 maximizes efficiency by adaptively regulating the output voltage. In this configuration the 500mV reference is connected to the non-inverting input of the error amplifier via mux S2 (see Figure 2, Block Diagram). The lowest of either  $V_{MAIN}$  or  $V_{SUB/FB}$  is then applied to the inverting input of the error amplifier via mux S1. This ensures that  $V_{MAIN}$  and  $V_{SUB/$

$V_{FB}$  are at least 500mV, thus providing enough voltage headroom at the input to the current sinks for proper current regulation.

In the instance when there are unequal numbers of LEDs or unequal currents from string to string, the string with the highest voltage will be the regulation point.

### UNISON/NON-UNISON MODE

Within White LED mode there are two separate modes of operation, Unison and Non-Unison. Non-Unison mode provides for independent current regulation, while Unison mode gives up independent regulation for more accurate matching between LED strings. When in Non-Unison mode the LED currents  $I_{MAIN}$  and  $I_{SUB/FB}$  are independently controlled via registers BMAIN and BSUB respectively (see Brightness Registers BMAIN and BSUB section). When in Unison mode BSUB is disabled and both  $I_{MAIN}$  and  $I_{SUB/FB}$  are controlled via BMAIN only.

### START-UP

The LM3528 features an internal soft-start, preventing large inrush currents during start-up that can cause excessive voltage ripple on the input. For the typical application circuits when the device is brought out of shutdown the average input current ramps from zero to 450mA in approximately 1.2ms. See Start Up Plots in the Typical Performance Characteristics.

### OLED MODE

When the LM3528 is configured for a single White LED bias + OLED display bias (OLED mode), the non-inverting input of the error amplifier is connected to the internal 1.21V reference via MUX S2. MUX S1 switches SUB/FB to the inverting input of the error amplifier while disconnecting the internal current sink at SUB/FB. The voltage at MAIN is not regulated in OLED mode so when the application requires white LED + OLED panel biasing, ensure that at least 300mV of headroom is maintained at MAIN to guarantee proper regulation of  $I_{MAIN}$ . (see the Typical Performance Characteristics for a plot of  $I_{LED}$  vs Current Source Headroom Voltage)

### PEAK CURRENT LIMIT

The LM3528's boost converter has a peak current limit for the internal power switch of 770mA typical (650mA minimum). When the peak switch current reaches the current limit the duty cycle is terminated resulting in a limit on the maximum output current and thus the maximum output power the LM3528 can deliver. Calculate the maximum LED current as a function of  $V_{IN}$ ,  $V_{OUT}$ , L and  $I_{PEAK}$  as:

$$I_{OUT\_MAX} = \frac{(I_{PEAK} - \Delta I_L) \times \eta \times V_{IN}}{V_{OUT}}$$

$$\text{where } \Delta I_L = \frac{V_{IN} \times (V_{OUT} - V_{IN})}{2 \times f_{SW} \times L \times V_{OUT}}$$

$f_{SW} = 1.27\text{MHz}$ . Typical values for efficiency and  $I_{PEAK}$  can be found in the efficiency and  $I_{PEAK}$  curves in the Typical Performance Characteristics.

### OVER VOLTAGE PROTECTION

The LM3528's output voltage ( $V_{OUT}$ ) is limited on the high end by the Output Over-Voltage Protection Threshold ( $V_{OVP}$ ) of 21.2V (min). In White LED mode during output open circuit

conditions the output voltage will rise to the over voltage protection threshold. When this happens the controller will stop switching causing  $V_{OUT}$  to droop. When the output voltage drops below 19.7V (min) the device will resume switching. If the device remains in an over voltage condition the LM3528 will repeat the cycle causing the output to cycle between the high and low OVP thresholds. See waveform for OVP condition in the Typical Performance Characteristics.

### OUTPUT CURRENT ACCURACY AND CURRENT MATCHING

The LM3528 provides both precise current accuracy (% error from ideal value) and accurate current matching between the MAIN and SUB/FB current sinks. Two modes of operation affect the current matching between  $I_{MAIN}$  and  $I_{SUB/FB}$ . The first mode (Non-Unison mode) is set by writing a 0 to bit 2 of the General Purpose register (UNI bit). Non-Unison mode allows for independent programming of  $I_{MAIN}$  and  $I_{SUB/FB}$  via registers BMAIN and BSUB respectively. In this mode typical matching between current sinks is 1%.

Writing a 1 to UNI configures the device for Unison mode. In Unison mode, BSUB is disabled and  $I_{MAIN}$  and  $I_{SUB/FB}$  are both controlled via register BMAIN. In this mode typical matching is 0.15%.

### LIGHT LOAD OPERATION

The LM3528 boost converter operates in three modes; continuous conduction, discontinuous conduction, and skip mode operation. Under heavy loads when the inductor current does not reach zero before the end of the switching period the device switches at a constant frequency. As the output current decreases and the inductor current reaches zero before the end of the switching cycle, the device operates in discontinuous conduction. At very light loads the LM3528 will enter skip mode operation causing the switching period to lengthen and the device to only switch as required to maintain regulation at the output.

### HARDWARE ENABLE/PATTERN GENERATOR/GENERAL PURPOSE I/O (HWEN/PGEN/GPIO)

HWEN/PGEN/GPIO can be configured for three different modes of operation; Hardware Enable, Pattern Generation, and General Purpose I/O. Register HPG at address 0x80 controls the functionality of this pin (see Table 6).

### HARDWARE ENABLE (HWEN)

On initial power-up HWEN/PGEN/GPIO defaults to the Hardware Enable (HWEN) state. In this mode HWEN/PGEN/GPIO is an active high open-drain input enable to the device. When in HWEN mode HWEN/PGEN/GPIO must be pulled up to at least  $0.7 \times V_{IO}$  to enable the device. In HWEN mode pulling HWEN/PGEN/GPIO below  $0.36 \times V_{IO}$  will shutdown the LM3528, resetting all registers, and forcing MAIN, SUB/FB, and SW high impedance. Bit 0 of the HPG register controls the HWEN function. Writing a '0' to this bit enables the HWEN mode. Writing a '1' to this bit disables the HWEN mode and allows selection between the other two modes.

### PATTERN GENERATOR (PGEN)

With bit 0 of the HPG register set to 1, HWEN/PGEN/GPIO can be programmed as an open drain Pattern Generator Output (PGEN). In PGEN mode a 32 bit pattern is output at HWEN/PGEN/GPIO. This pattern can be programmed to repeat itself at 4 different frequencies and 6 different duty cycles. The arbitrary pattern is programmed into four 8 bit registers; PGEN0 (address 0x90), PGEN1 (address 0x91), PGEN2 (address 0x92), and PGEN3 (address 0x93) (see



Figures 12 - 15). Figure 16 details an example of a 32 bit pattern at a specific programmed duty cycle and frequency. A '1' written to the PGEN\_ registers forces HWEN/PGEN/GPIO low. A '0' causes HWEN/PGEN/GPIO to go open drain.

Bits <5:3> in the HPG register have three functions; GPIO enable, duty cycle select, and pattern latch. Any combination of these bits other than '000' or '111' puts HWEN/PGEN/GPIO into PGEN mode at the specified duty cycle shown in Table 6. Writing a '111' to bits <5:3> latches the 32 bit pattern programmed into the 4 pattern generator registers PGEN0, PGEN1, PGEN2, PGEN3 into the internal shift register. When bits <5:3> = '000' the PGEN mode is off and HWEN/PGEN/GPIO is configured as a GPIO.

Bits <7:6> of the HPG register control the pattern frequency. See Table 6 for the detailed breakdown of each available frequency. Figure 16 details the pattern programming and figure 17 shows the pattern output at HWEN/PGEN/GPIO.

#### GENERAL PURPOSE I/O (GPIO1)

With bits <5:3> and bit 0 of the HPG register all set to '0' HWEN/PGEN/GPIO functions as an open drain General Purpose I/O. In this mode, bit 1 of the HPG register controls the logic direction (Input or Output) and bit 2 holds the logic data. With bit 1 set to '0' HWEN/PGEN/GPIO is configured as an output. In this mode a '0' written to bit 2 forces HWEN/PGEN/GPIO to logic low. Likewise, a '1' written to bit 2 will force HWEN/PGEN/GPIO open drain. When bit 1 is set to '1' HWEN/PGEN/GPIO is configured as a logic input. In this mode when HWEN/PGEN/GPIO is externally pulled low a '0' is written to bit 2 of the HPG register. Likewise, when HWEN/PGEN/GPIO is externally pulled high a '1' is written to bit 2 of the HPG register. Table 6 and Figure 10 detail the bit functions

of the HPG register and their power-on-reset values. Note that the logic output levels for the GPIO function of this pin are inverted compared to the PGEN functions. For example, a 1 written to the PGEN registers cause the HWEN/PGEN/GPIO pin to pull low while a 1 written to the bit 2 of the HPG register causes the pin to go open drain.

#### GENERAL PURPOSE I/O (GPIO0)

The GPIO pin is a dedicated General Purpose I/O (open drain) and is controlled via the GPIO register at address 0x81. Bit 1 holds the logic data while bit 0 controls the logic direction (Input or Output). Bits <7:2> are un-used and will always read back as logic '1'. With bit 0 set to '0' GPIO is configured as an output. In this mode a '0' written to bit 1 forces GPIO to a logic low. Likewise, a '1' written to bit 1 will force GPIO to logic high. When bit 0 is set to '1' GPIO is configured as a logic input. In this mode when GPIO is externally pulled low a '0' is written to bit 1 of the GPIO register. Likewise, when GPIO is externally pulled high a '1' is written to bit 2 of the HPG register. Table 7 and Figure 11 detail the bit functions and power-on-reset values of GPIO.

During an initial GPIO write two I2C sequences (Slave I.D, Register Address, Register Data) are required to change the state of the GPIO pin. The first write configures the GPIO pin as an output. The second write will change the state of the GPIO output to the desired logic '1' or '0'.

#### THERMAL SHUTDOWN

The LM3528 offers a thermal shutdown protection. When the die temperature reaches +140°C the device will shutdown and not turn on again until the die temperature falls below +120°C.

**I<sup>2</sup>C COMPATIBLE INTERFACE**

The LM3528 is controlled via an I<sup>2</sup>C compatible interface. START and STOP conditions classify the beginning and the end of the I<sup>2</sup>C session. A START condition is defined as SDA transitioning from HIGH to LOW while SCL is HIGH. A STOP condition is defined as SDA transitioning from LOW to HIGH while SCL is HIGH. The I<sup>2</sup>C master always generates START and STOP conditions. The I<sup>2</sup>C bus is considered busy after a

START condition and free after a STOP condition. During data transmission, the I<sup>2</sup>C master can generate repeated START conditions. A START and a repeated START conditions are equivalent function-wise. The data on SDA must be stable during the HIGH period of the clock signal (SCL). In other words, the state of SDA can only be changed when SCL is LOW.

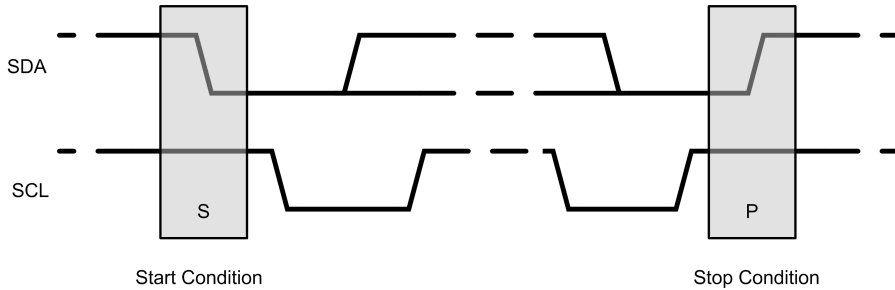

30020537

**FIGURE 3. Start and Stop Sequences**

**I<sup>2</sup>C COMPATIBLE ADDRESS**

The chip address for the LM3528 is 0110110 (36h). After the START condition, the I<sup>2</sup>C master sends the 7-bit chip address followed by a read or write bit (R/W). R/W= 0 indicates a

WRITE and R/W = 1 indicates a READ. The second byte following the chip address selects the register address to which the data will be written. The third byte contains the data for the selected register.

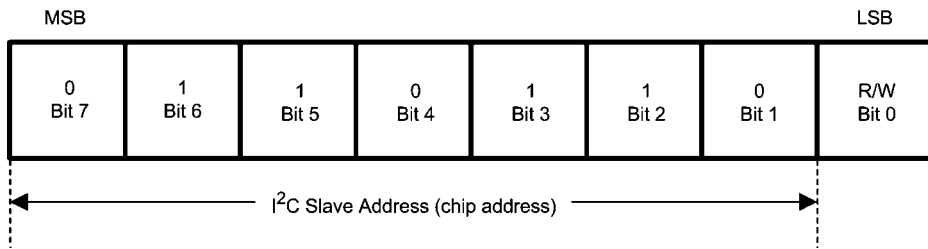

30020538

**FIGURE 4. Chip Address**

**TRANSFERRING DATA**

Every byte on the SDA line must be eight bits long, with the most significant bit (MSB) transferred first. Each byte of data must be followed by an acknowledge bit (ACK). The acknowledge related clock pulse (9th clock pulse) is generated by the master. The master releases SDA (HIGH) during the 9th clock

pulse. The LM3528 pulls down SDA during the 9th clock pulse, signifying an acknowledge. An acknowledge is generated after each byte has been received. Figure 5 is an example of a write sequence to the General Purpose register of the LM3528.

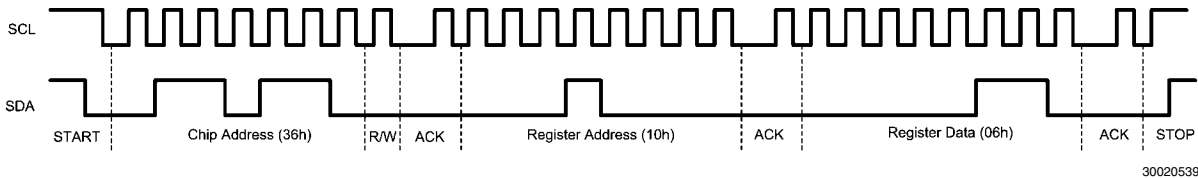

30020539

**FIGURE 5. Write Sequence to the LM3528**

## REGISTER DESCRIPTIONS

There are 4, 8 bit registers within the LM3528 as detailed in Table 1.

### TABLE 1. LM3528 Register Descriptions

Register Name	Hex Address	Power -On-Value
General Purpose (GP)	0x10	0xC0
Brightness Main (BMAIN)	0xA0	0xE0
Brightness Sub (BSUB)	0xB0	0xE0
HWEN/PGEN/GPIO Control (HPG)	0x80	0XF8
General Purpose I/O Control (GPIO)	0x81	0xFC
Pattern Register 0 (PGEN0)	0x90	0x00
Pattern Register 1 (PGEN1)	0x91	0x00
Pattern Register 2 (PGEN2)	0x92	0x00
Pattern Register 3 (PGEN3)	0x93	0x00

#### GENERAL PURPOSE REGISTER (GP)

The General Purpose register has four functions. It controls the on/off state of MAIN and SUB/FB, it selects between Unison or Non-Unison mode, provides for control over the rate of change of the LED current (see Brightness Rate of Change

Description), and selects between White LED and OLED mode. Figure 6 and Table 2 describes each bit available within the General Purpose Register. Table 3 summarizes the output state of the LM3528 for the different combinations of General Purpose register settings.

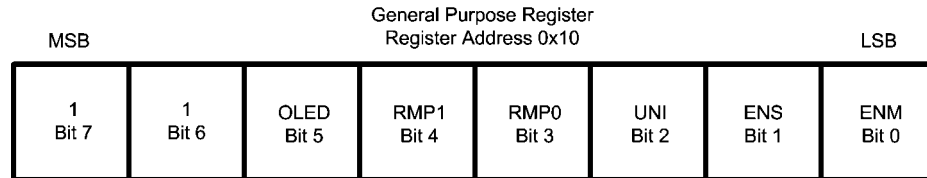

30020540

FIGURE 6. General Purpose Register Description

### TABLE 2. General Purpose Register Bit Function

Bit	Name	Function	Power-On-Value
0	ENM	Enable MAIN. Writing a 1 to this bit enables the main current sink (MAIN). Writing a 0 to this bit disables the main current sink and forces MAIN high impedance.	0
1	ENS	Enable SUB/FB. Writing a 1 to this bit enables the secondary current sink (SUB/FB). Writing a 0 to this bit disables the secondary current sink and forces SUB/FB high impedance.	0
2	UNI	Unison Mode Select. Writing a 1 to this bit disables the BSUB register and causes the contents of BMAIN to set the current in both the MAIN and SUB/FB current sinks. Writing a 0 to this bit allows the current into MAIN and SUB/FB to be independently controlled via the BMAIN and BSUB registers respectively.	0
3	RMP0	Brightness Rate of Change. Bits RMP0 and RMP1 set the rate of change of the LED current into MAIN and SUB/FB in response to changes in the contents of registers BMAIN and BSUB (see brightness rate of change description).	0
4	RMP1		0
5	OLED	OLED = 0 places the LM3528 in White LED mode. In this mode both the MAIN and SUB/FB current sinks are active. The boost converter ensures there is at least 500mV at $V_{MAIN}$ and $V_{SUB/FB}$ .  OLED = 1 places the LM3528 in OLED mode. In this mode the boost converter regulates $V_{SUB/FB}$ to 1.244V. $V_{MAIN}$ is unregulated and must be > 400mV for the MAIN current sink to maintain current regulation.	0
6	Don't Care	These are non-functional read only bits. They will always read back as a 1.	1
7			

**TABLE 3. Operational Truth Table**

UNI	OLED	ENM	ENS	Result
X	0	0	0	LM3528 Disabled
1	0	1	X	MAIN and SUB/FB current sinks enabled. Current levels set by contents of BMAIN.
1	0	0	X	MAIN and SUB/FB Disabled
0	0	0	1	SUB/FB current sink enabled. Current level set by BSUB.
0	0	1	0	MAIN current sink enabled. Current level set by BMAIN.
0	0	1	1	MAIN and SUB/FB current sinks enabled. Current levels set by contents of BMAIN and BSUB respectively.
X	1	1	X	SUB/FB current sink disabled (SUB/FB configured as a feedback pin). MAIN current sink enabled current level set by BMAIN.
X	1	0	X	SUB/FB current sink disabled (SUB/FB configured as a feedback pin). MAIN current sink disabled.

\* ENM ,ENS, or OLED high enables analog circuitry.

#### BRIGHTNESS REGISTERS (BMAIN and BSUB)

With the UNI bit (General Purpose register) set to 0 (Non-Unison mode) both brightness registers (BMAIN and BSUB) independently control the LED currents  $I_{MAIN}$  and  $I_{SUB/FB}$  respectively. BMAIN and BSUB are both 8 bit, but with only the 7 LSB's controlling the current. The MSB's is a don't care. The LED current control is designed to approximate an exponentially increasing response of the LED current vs increasing code in either BMAIN or BSUB (see Figure 9). Program  $I_{LED\_MAX}$  by connecting a resistor (RSET) from SET to GND, where:

$$I_{LED\_MAX} = 192 \times \frac{1.244V}{R_{SET}}$$

With the UNI bit (General Purpose register) set to 1 (Unison mode), BSUB is disabled and BMAIN sets both  $I_{MAIN}$  and  $I_{SUB/FB}$ . This prevents the independent control of  $I_{MAIN}$  and  $I_{SUB/FB}$ , however matching between current sinks goes from typically 1% (with UNI = 0) to typically 0.15% (with UNI = 1). Figure 7 and Figure 8 show the register descriptions for the Brightness MAIN and Brightness SUB registers. Table 4 and Figure 9 show  $I_{MAIN}$  and/or  $I_{SUB/FB}$  vs. brightness data as a percentage of  $I_{LED\_MAX}$ .

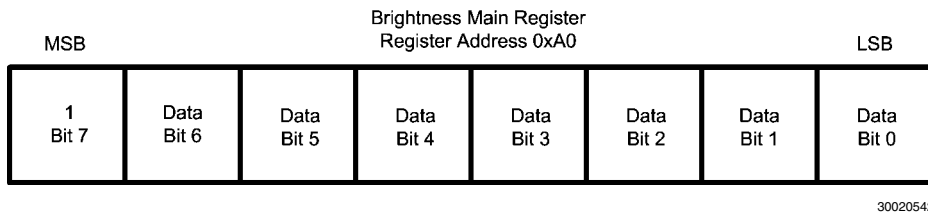
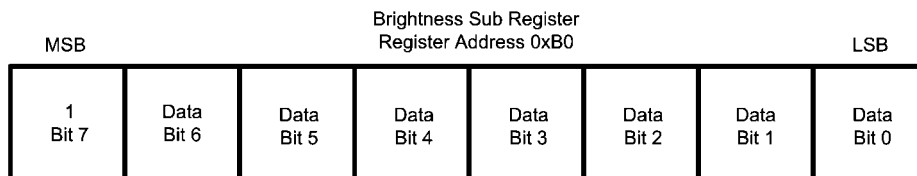
**FIGURE 7. Brightness MAIN Register Description****FIGURE 8. Brightness SUB Register Description**

**TABLE 4.  $I_{LED}$  vs. Brightness Register Data**

BMAIN or BSUB Brightness Data	% of $I_{LED\_MAX}$	BMAIN or BSUB Brightness Data	% of $I_{LED\_MAX}$	BMAIN or BSUB Brightness Data	% of $I_{LED\_MAX}$	BMAIN or BSUB Brightness Data	% of $I_{LED\_MAX}$
0000000	0.000%	0100000	0.803%	1000000	4.078%	1100000	20.713%
0000001	0.166%	0100001	0.845%	1000001	4.290%	1100001	21.792%
0000010	0.175%	0100010	0.889%	1000010	4.514%	1100010	22.928%
0000011	0.184%	0100011	0.935%	1000011	4.749%	1100011	24.122%
0000100	0.194%	0100100	0.984%	1000100	4.996%	1100100	25.379%
0000101	0.204%	0100101	1.035%	1000101	5.257%	1100101	26.701%
0000110	0.214%	0100110	1.089%	1000110	5.531%	1100110	28.092%
0000111	0.226%	0100111	1.146%	1000111	5.819%	1100111	29.556%
0001000	0.237%	0101000	1.205%	1001000	6.122%	1101000	31.096%
0001001	0.250%	0101001	1.268%	1001001	6.441%	1101001	32.716%
0001010	0.263%	0101010	1.334%	1001010	6.776%	1101010	34.420%
0001011	0.276%	0101011	1.404%	1001011	7.129%	1101011	36.213%
0001100	0.291%	0101100	1.477%	1001100	7.501%	1101100	38.100%
0001101	0.306%	0101101	1.554%	1001101	7.892%	1101101	40.085%
0001110	0.322%	0101110	1.635%	1001110	8.303%	1101110	42.173%
0001111	0.339%	0101111	1.720%	1001111	8.735%	1101111	44.371%
0010000	0.356%	0110000	1.809%	1010000	9.191%	1110000	46.682%
0010001	0.375%	0110001	1.904%	1010001	9.669%	1110001	49.114%
0010010	0.394%	0110010	2.003%	1010010	10.173%	1110010	51.673%
0010011	0.415%	0110011	2.107%	1010011	10.703%	1110011	54.365%
0010100	0.436%	0110100	2.217%	1010100	11.261%	1110100	57.198%
0010101	0.459%	0110101	2.332%	1010101	11.847%	1110101	60.178%
0010110	0.483%	0110110	2.454%	1010110	12.465%	1110110	63.313%
0010111	0.508%	0111011	2.582%	1010111	13.114%	1110111	66.611%
0011000	0.535%	0110111	2.716%	1011000	13.797%	1111000	70.082%
0011001	0.563%	0111000	2.858%	1011001	14.516%	1111001	73.733%
0011010	0.592%	0111001	3.007%	1011010	15.272%	1111010	77.574%
0011011	0.623%	0111010	3.163%	1011011	16.068%	1111011	81.616%
0011100	0.655%	0111011	3.328%	1011100	16.905%	1111100	85.868%
0011101	0.689%	0111100	3.502%	1011101	17.786%	1111101	90.341%
0011110	0.725%	0111101	3.684%	1011110	18.713%	1111110	95.048%
0011111	0.763%	0111111	3.876%	1011111	19.687%	1111111	100.000%

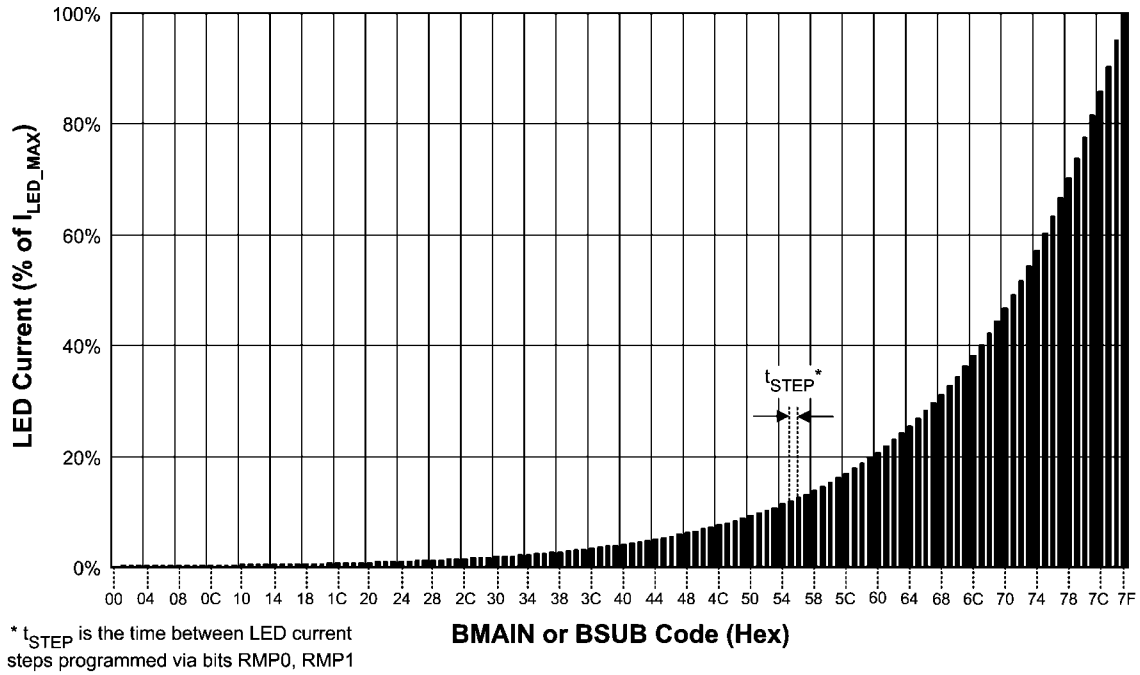

30020544

FIGURE 9.  $I_{MAIN}$  or  $I_{SUB}$  vs BMAIN or BSUB Data**BRIGHTNESS RATE OF CHANGE DESCRIPTION**

RMP0 and RMP1 control the rate of change of the LED current  $I_{MAIN}$  and  $I_{SUB/FB}$  in response to changes in BMAIN and/or BSUB. There are 4 user programmable LED current rates of change settings for the LM3528 (see Table 5).

**TABLE 5. Rate of Change Bits**

RMP0	RMP1	Change Rate ( $t_{STEP}$ )
0	0	12.75 $\mu$ s/step
0	1	3.25ms/step
1	0	6.5ms/step
1	1	13ms/step

For example, if  $R_{SET} = 12.1k\Omega$  then  $I_{LED\_MAX} = 20mA$ . With the contents of BMAIN set to 0x7F ( $I_{MAIN} = 20mA$ ), suppose the contents of BMAIN are changed to 0x00 resulting in ( $I_{MAIN} = 0mA$ ). With RMP0 = 1 and RMP1 = 1 (13ms/step),  $I_{MAIN}$  will change from 20mA to 0mA in 127 steps with 13ms elapsing between steps, excluding the step from 0x7F to 0x7E, resulting in a full scale current change in 1638ms. The total time to transition from one brightness code to another is:

$$t_{transition} = (|InitialCode - FinalCode| - 1) \times t_{STEP}$$

The following 3 additional examples detail possible scenarios when using the brightness register in conjunction with the rate of change bits and the enable bits.

**Example 1:**

Step 1: Write to BMAIN a value corresponding to  $I_{MAIN} = 20mA$ .

Step 2: Write 1 to ENM (turning on MAIN)

Step 3:  $I_{MAIN}$  ramps to 20mA with a rate set by RMP0 and RMP1. (RMP0 and RMP1 bits set the duration spent at one brightness code before incrementing to the next).

Step 4: ENM is set to 0 before 20mA is reached, thus the LED current fades off at a rate given by RMP0 and RMP1 without  $I_{MAIN}$  going up to 20mA.

**Example 2:**

Step 1: ENM is 1, and BMAIN has been programmed with code 0x01. This results in a small current into MAIN.

Step 2: BMAIN is programmed with 0x7F (full scale current). This causes  $I_{MAIN}$  to ramp toward full-scale at the rate selected by RMP0 and RMP1.

Step 3: Before  $I_{MAIN}$  reaches full-scale BMAIN is programmed with 0x30.  $I_{MAIN}$  will continue to ramp to full scale.

Step 4: When  $I_{MAIN}$  has reached full-scale value it will ramp down to the current corresponding to 0x30 at a rate set by RMP0 and RMP1.

**Example 3:**

Step 1: Write to BMAIN a value corresponding to  $I_{MAIN} = 20mA$ .

Step 2: Write a 1 to both RMP0 and RMP1.

Step 3: Write 1 to ENM (turning on MAIN).

Step 4:  $I_{MAIN}$  ramps toward 20mA with a rate set by RMP0 and RMP1. (RMP0 and RMP1 bits set the duration spent at one brightness code before incrementing to the next).

Step 5: After 1.222s  $I_{MAIN}$  has ramped to 19.687% of  $I_{LED\_MAX}$  ( $0.19687 \times 20mA = 3.9374mA$ ). Simultaneously, RMP0 and RMP1 are both programmed with 0.

Step 6:  $I_{MAIN}$  continues ramping from 3.9374mA to 20mA, but at a new ramp rate of 12.75 $\mu$ s/step.

**TABLE 6. HPG Register Function**

Bits 7 – 6 (PGEN Bit Period)	Bits 5 - 3 (PGEN Enable/Disable and Duty Cycle Selection)	Bit 2 (GPIO Data)	Bit 1 (GPIO Data Direction)	Bit 0 (HWEN Control)	Function
X	X	X	X	0	HWEN/PGEN/GPIO is configured as an active high Hardware Enable Input (HWEN)
00 = 1.6µs/bit (625kHz) 01 = 26ms/bit (38Hz) 10 = 52ms/bit (19Hz) 11 = 105ms/bit (9.5Hz) <b>Note 1</b>	001 = 100% 010 = 1/2 011 = 1/3 100 = 1/4 101 = 1/6 110 = 1/12 111 = Latch Pattern Into Shift Register <b>Note 2</b>	X	X	1	HWEN/PGEN/GPIO is configured as a Pattern Generator Output with the frequency set by bits <7:6> and the duty cycle set by bits <5:3>. (See Figure 11.)
X	000	GPIO Read Data	1	1	HWEN/PGEN/GPIO is configured as a GPIO Input. Read data from bit 2.
X	000	GPIO Write Data	0	1	HWEN/PGEN/GPIO is configured as a GPIO Output. A '1' written to bit 2 will force HWEN/PGEN/GPIO high; a 0 written to bit 2 will force HWEN/PGEN/GPIO low.

**Note 1:** This represents the amount of time each programmed bit will be present at HWEN/PGEN/GPIO. The entire pattern period will be 32 × Bit Period.

**Note 2:** This duty cycle indicates the fraction of time the pattern is being output at HWEN/PGEN/GPIO. For example the 1/2 duty cycle (bits <5:3> = 010) will have the 32 bit pattern

output once followed by a dead time (HWEN/PGEN/GPIO high impedance) equal to 1×'s the pattern period (Deadtime = 32 × Bit\_Period × (1/DutyCycle - 1)). For the 100% duty cycle setting the 32 bit pattern will repeat constantly with no dead-time.

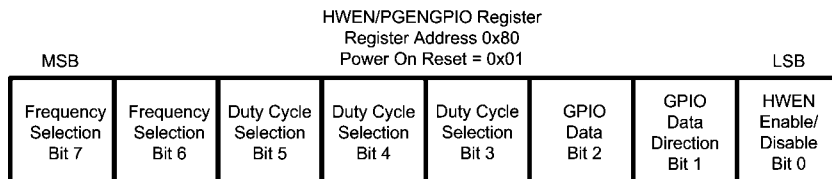

30020546

**FIGURE 10. HPG Register Description**

## GPIO Register Function

Bits 7 - 2	GPIO Data (Bit 1)	Data Direction (Bit 0)	Function
X	X	0	GPIO is configured as a GPIO input with the input data read back via bit [1]. This is the default power on state.
X	X	1	GPIO is configured as a logic output. The output logic voltage is written to bit [1].

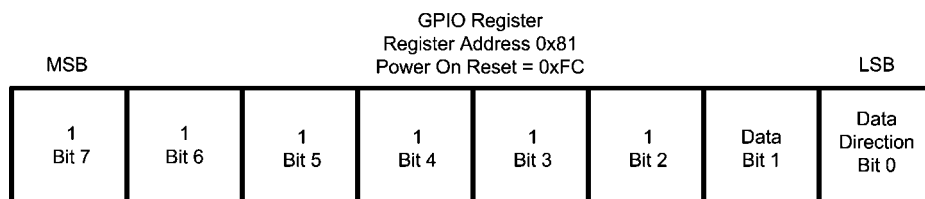

30020564

**FIGURE 11. GPIO Register Description**

Figures 12 – 15 detail the Pattern Generator Data Registers. These hold the 32 bit data that is output at HWEN/PGEN/

GPIO in PGEN mode. The data is output LSB first (Bit 0 of PGEN0) and MSB last (Bit 7 of PGEN3).

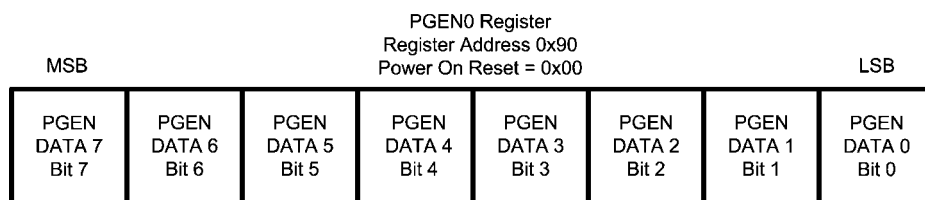

30020565

**FIGURE 12. PGEN0 Register Description**

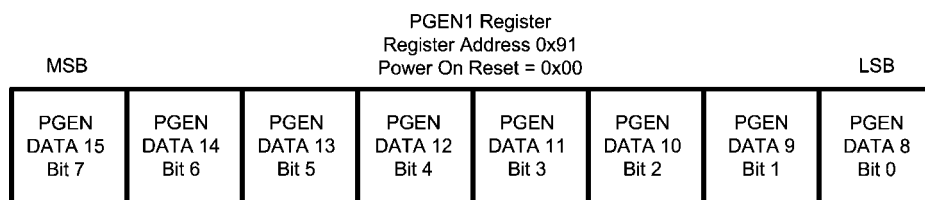

30020566

**FIGURE 13. PGEN1 Register Description**



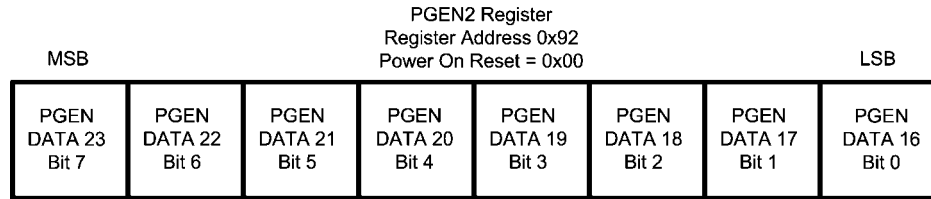

30020567

FIGURE 14. PGEN2 Register Description

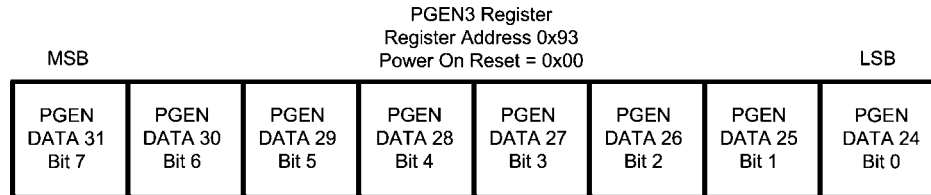

30020568

FIGURE 15. PGEN3 Register Description

Figure 16 shows a write sequence to the pattern generator programmed to output the waveform in Figure 17. In this example HPG register bits <7:6> = 01 (for 26ms/bit) and bits <5:3> = 010 (for 1/2 duty cycle). The pattern data in registers (PGEN0 – PGEN2) are all loaded with 0xAC. A '1' will force the HWEN/PGEN/GPIO output low while a '0' will force HWEN/PGEN/GPIO open drain. When set for a 26ms/bit period the pattern will be output LSB first (PGEN0, bit 0) and repeat every

When set for 1/2 duty cycle there will be a dead time (HWEN/PGEN/GPIO high impedance) between each pattern and equal to the pattern period. In applications where HWEN/PGEN/GPIO is used to pull current through an indicator LED a '1' corresponds to the LED on and a '0' corresponds to the LED off.

$$t_{\text{PERIOD}} = \frac{26 \text{ ms/bit} \times 32 \text{ bits}}{1/2 \text{ Dutycycle}} = 1.664\text{s}$$

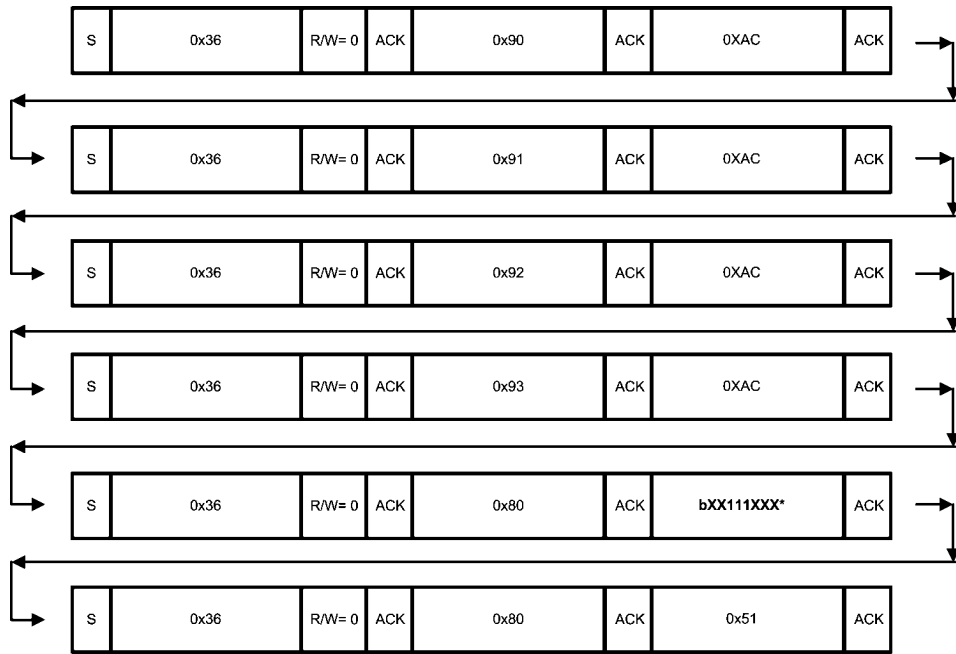

\*Only bits <5:3> are necessary in this byte the rest are don't cares. Bits <5:3> = '111' are necessary to latch the pattern generator data bits into the internal shift register.

30020569

FIGURE 16. Pattern Generation Write Sequence

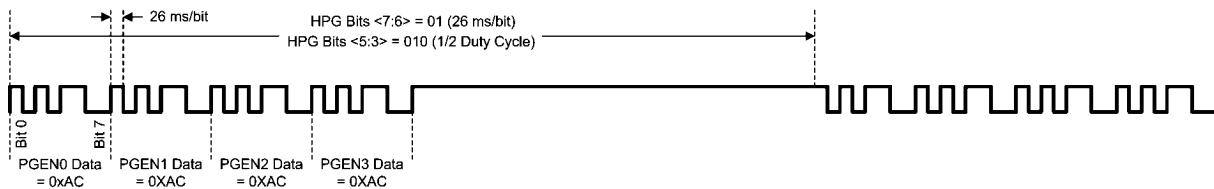

30020570

FIGURE 17. Pattern Generation Output

### SHUTDOWN AND OUTPUT ISOLATION

The LM3528 provides a true shutdown for either MAIN or SUB/FB when configured as a White LED bias supply. Write a 0 to ENM (bit 1) of the General Purpose register to turn off the MAIN current sink and force MAIN high impedance. Write a 0 to ENS (bit 2) of the General Purpose register to turn off

the SUB/FB current sink and force SUB/FB high impedance. Writing a 1 to ENM or ENS turns on the MAIN and SUB/FB current sinks respectively. When in shutdown the leakage current into MAIN or SUB/FB is typically 1.8 $\mu$ A. See Typical Performance Plots for start-up responses of the LM3528 using the ENM and ENS bits in White LED and OLED modes.

## Application Information

### LED CURRENT SETTING/MAXIMUM LED CURRENT

Connect a resistor ( $R_{SET}$ ) from SET to GND to program the maximum LED current ( $I_{LED\_MAX}$ ) into MAIN or SUB/FB. The  $R_{SET}$  to  $I_{LED\_MAX}$  relationship is:

$$I_{LED\_MAX} = 192 \times \frac{1.244V}{R_{SET}}$$

where SET provides the constant 1.244V output.

### OUTPUT VOLTAGE SETTING (OLED MODE)

Connect Feedback resistors from the converters output to SUB/FB to GND to set the output voltage in OLED mode (see R1 and R2 in the Typical Application Circuit (OLED Panel Power Supply)). First select  $R2 < 100k\Omega$  then calculate R1 such that:

$$R1 = R2 \left( \frac{V_{OUT}}{1.21V} - 1 \right)$$

In OLED mode the MAIN current sink continues to regulate the current through MAIN, however,  $V_{MAIN}$  is no longer regulated. To avoid dropout and ensure proper current regulation the application must ensure that  $V_{MAIN} > 0.3V$ .

### OUTPUT CAPACITOR SELECTION

The LM3528's output capacitor supplies the LED current during the boost converters on time. When the switch turns off the inductor energy is discharged through the diode supplying power to the LED's and restoring charge to the output capacitor. This causes a sag in the output voltage during the on time and a rise in the output voltage during the off time. The output capacitor is therefore chosen to limit the output ripple to an acceptable level depending on LED or OLED panel current requirements and input/output voltage differentials. For proper operation ceramic output capacitors ranging from 1 $\mu$ F to 2.2 $\mu$ F are required.

As with the input capacitor, the output voltage ripple is composed of two parts, the ripple due to capacitor discharge (delta  $V_Q$ ) and the ripple due to the capacitors ESR (delta  $V_{ESR}$ ). For continuous conduction mode, the ripple components are found by:

$$\Delta V_Q = \frac{I_{LED} \times (V_{OUT} - V_{IN})}{f_{SW} \times V_{OUT} \times C_{OUT}} \quad \text{and}$$

$$\Delta V_{ESR} = R_{ESR} \times \left( \frac{I_{LED} \times V_{OUT}}{V_{IN}} + \Delta I_L \right)$$

$$\text{where } \Delta I_L = \frac{V_{IN} \times (V_{OUT} - V_{IN})}{2 \times f_{SW} \times L \times V_{OUT}}$$

### INPUT CAPACITOR SELECTION

Choosing the correct size and type of input capacitor helps minimize the input voltage ripple caused by the switching of the LM3528's boost converter. For continuous inductor current operation the input voltage ripple is composed of 2 primary components, the capacitor discharge (delta  $V_Q$ ) and the capacitor's equivalent series resistance (delta  $V_{ESR}$ ). These ripple components are found by:

$$\Delta V_Q = \frac{\Delta I_L \times D}{2 \times f_{SW} \times C_{IN}}$$

and

$$\Delta V_{ESR} = 2 \times \Delta I_L \times R_{ESR}$$

$$\text{where } \Delta I_L = \frac{V_{IN} \times (V_{OUT} - V_{IN})}{2 \times f_{SW} \times L \times V_{OUT}}$$

In the typical application circuit a 1 $\mu$ F ceramic input capacitor works well. Since the ESR in ceramic capacitors is typically less than 5m $\Omega$  and the capacitance value is usually small, the input voltage ripple is primarily due to the capacitive discharge. With larger value capacitors such as tantalum or aluminum electrolytic the ESR can be greater than 0.5 $\Omega$ . In this case the input ripple will primarily be due to the ESR.

Table 7 lists different manufacturers for various capacitors and their case sizes that are suitable for use with the LM3528. When configured as a dual output LED driver a 1 $\mu$ F output capacitor is adequate. In OLED mode for output voltages above 12V a 2.2 $\mu$ F output capacitor is required (see Low Output Voltage Operation (OLED) Section).

**TABLE 7. Recommended Output Capacitors**

Manufacturer	Part Number	Value	Case Size	Voltage Rating
TDK	C1608X5R1E105M	1 $\mu$ F	0603	25V
Murata	GRM39X5R105K25D539	1 $\mu$ F	0603	25V
TDK	C2012X5R1E225M	2.2 $\mu$ F	0805	25V
Murata	GRM219R61E225KA12	2.2 $\mu$ F	0805	25V

**INDUCTOR SELECTION**

The LM3528 is designed for use with a 10 $\mu$ H inductor, however 22 $\mu$ H are suitable providing the output capacitor is increased 2x. When selecting the inductor ensure that the saturation current rating ( $I_{SAT}$ ) for the chosen inductor is high enough and the inductor is large enough such that at the maximum LED current the peak inductor current is less than the LM3528's peak switch current limit. This is done by choosing:

$$I_{SAT} > \frac{I_{LED}}{\eta} \times \frac{V_{OUT}}{V_{IN}} + \Delta I_L \quad \text{where}$$

$$\Delta I_L = \frac{V_{IN} \times (V_{OUT} - V_{IN})}{2 \times f_{SW} \times L \times V_{OUT}}, \text{ and}$$

$$L > \frac{V_{IN} \times (V_{OUT} - V_{IN})}{2 \times f_{SW} \times V_{OUT} \times \left( I_{PEAK} - \frac{I_{LED\_MAX} \times V_{OUT}}{\eta \times V_{IN}} \right)}$$

Values for  $I_{PEAK}$  can be found in the plot of peak current limit vs.  $V_{IN}$  in the Typical Performance Characteristics graphs. Table 8 shows possible inductors, as well as their corresponding case size and their saturation current ratings.

**TABLE 8. Recommended Inductors**

Manufacturer	Part Number	Value	Dimensions	$I_{SAT}$	DC Resistance
TDK	VLF3012AT-100MR49	10 $\mu$ H	2.6mmx2.8mmx1mm	490mA	0.36 $\Omega$
Coilcraft	LPS3008-103ML	10 $\mu$ H	2.95mmx2.95mmx0.8mm	490mA	0.65 $\Omega$
TDK	VLF4012AT-100MR79	10 $\mu$ H	3.5mmx3.7mmx1.2mm	800mA	0.3 $\Omega$
Coilcraft	LPS4012-103ML	10 $\mu$ H	3.9mmx3.9mmx1.1mm	700mA	0.35 $\Omega$
TOKO	A997AS-100M	10 $\mu$ H	3.8mmx3.8mmx1.8mm	580mA	0.18 $\Omega$

**DIODE SELECTION**

The output diode must have a reverse breakdown voltage greater than the maximum output voltage. The diodes average current rating should be high enough to handle the LM3528's output current. Additionally, the diodes peak current rating must be high enough to handle the peak inductor current. Schottky diodes are recommended due to their lower

forward voltage drop (0.3V to 0.5V) compared to (0.6V to 0.8V) for PN junction diodes. If a PN junction diode is used, ensure it is the ultra-fast type ( $t_{rr} < 50$ ns) to prevent excessive loss in the rectifier. For Schottky diodes the B05030WS (or equivalent) work well for most designs. See Table 9 for a list of other Schottky Diodes with similar performance.

**TABLE 9. Recommended Schottky Diodes**

Manufacturer	Part Number	Package	Reverse Breakdown Voltage	Average Current Rating
On Semiconductor	NSR0230P2T5G	SOD-923 (0.8mm×0.6mm×0.4mm)	30V	200mA
On Semiconductor	NSR0230M2T5G	SOD-723 (1mm×0.6mm×0.52mm)	30V	200mA
On Semiconductor	RB521S30T1	SOD-523 (1.2mm×0.8mm×0.6mm)	30V	200mA
Diodes Inc.	SDM20U30	SOD-523 (1.2mm×0.8mm×0.6mm)	30V	200mA
Diodes Inc.	B05030WS	SOD-323 (1.6mm×1.2mm×1mm)	30V	0.5A
Philips	BAT760	SOD-323 (1.6mm×1.2mm×1mm)	20V	1A

**OUTPUT CURRENT RANGE (OLED MODE)**

The maximum output current the LM3528 can deliver in OLED mode is limited by 4 factors (assuming continuous conduction); the peak current limit of 770mA (typical), the inductor value, the input voltage, and the output voltage. Calculate the maximum output current ( $I_{OUT\_MAX}$ ) using the following equation:

$$I_{OUT\_MAX} = \frac{(I_{PEAK} - \Delta I_L) \times \eta \times V_{IN}}{V_{OUT}}$$

where

$$\Delta I_L = \frac{V_{IN} \times (V_{OUT} - V_{IN})}{2 \times f_{SW} \times L \times V_{OUT}}$$

For the typical application circuit with  $V_{OUT} = 18V$  and assuming 70% efficiency, the maximum output current at  $V_{IN} = 2.7V$  will be approximately 70mA. At 4.2V due to the shorter on times and lower average input currents the maximum output current (at 70% efficiency) jumps to approximately 105mA. Figure 11 shows a plot of  $I_{OUT\_MAX}$  vs.  $V_{IN}$  using the above equation, assuming 80% efficiency. In reality, factors such as current limit and efficiency will vary over  $V_{IN}$ , temperature, and component selection. This can cause the actual  $I_{OUT\_MAX}$  to be higher or lower.

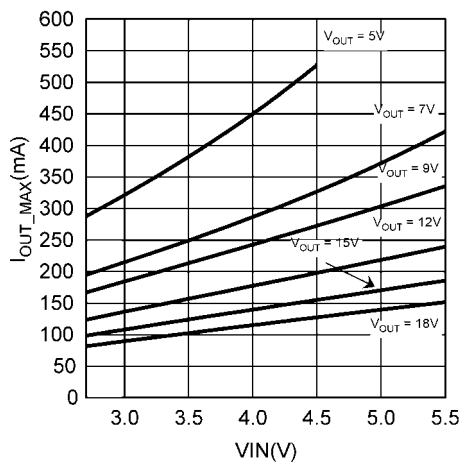

30020562

**FIGURE 18. Typical Maximum Output Current in OLED Mode (assumed 80% efficiency)**

**OUTPUT VOLTAGE RANGE (OLED MODE)**

The LM3528's output voltage is constrained by 2 factors. On the low end it is limited by the minimum duty cycle of 10% (assuming continuous conduction) and on the high end it is limited by the over voltage protection threshold ( $V_{OVP}$ ) of 22V (typical). In order to maintain stability when operating at different output voltages the output capacitor and inductor must be changed. Refer to Table 10 for different  $V_{OUT}$ ,  $C_{OUT}$ , and L combinations.

**TABLE 10. Component Values for Output Voltage Selection**

V <sub>OUT</sub>	C <sub>OUT</sub>	L	V <sub>IN</sub> Range
18V	2.2μF	10μH	2.7V to 5.5V
15V	2.2μF	10μH	2.7V to 5.5V
12V	4.7μF	10μH	2.7V to 5.5V
9V	10μF	10μH	2.7V to 5.5V
7V	10μF	4.7μH	2.7V to 5.5V
5V	22μF	4.7μH	2.7V to 4.5V

## APPLICATION CIRCUITS

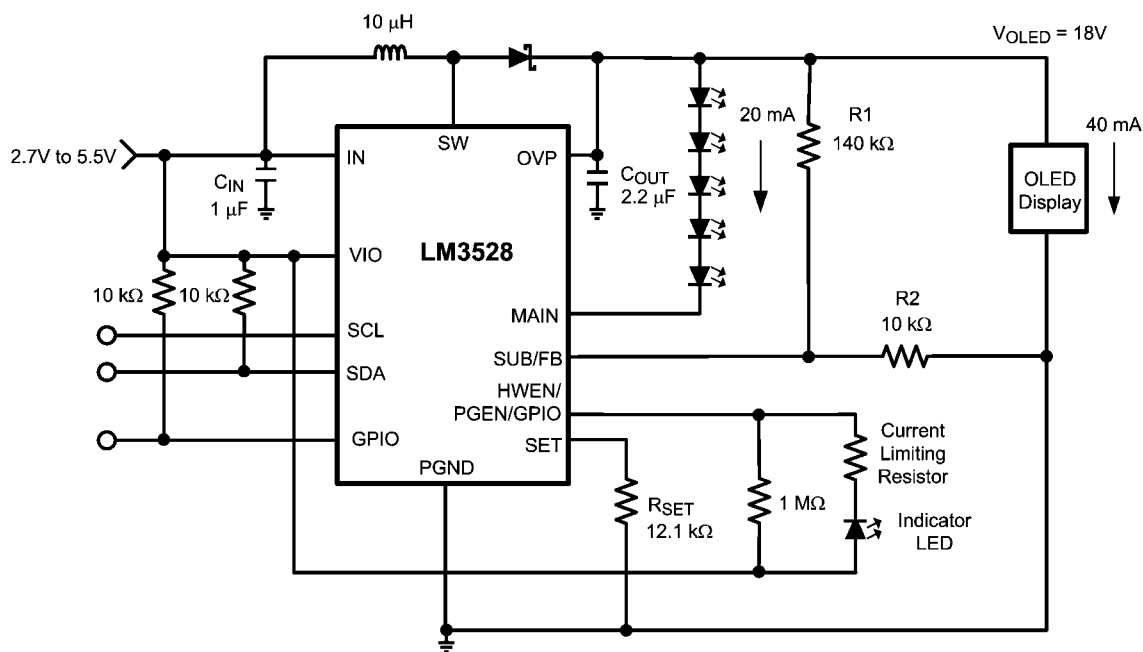

OLED Panel Power Supply With Indicator LED

30020561

FIGURE 19. LED Backlight + OLED Power Supply

## LAYOUT CONSIDERATIONS

Refer to AN-1112 for  $\mu$ SMD package soldering

The high switching frequencies and large peak currents in the LM3528 make the PCB layout a critical part of the design. The proceeding steps should be followed to ensure stable operation and proper current source regulation.

1,  $C_{IN}$  should be located on the top layer and as close to the device as possible. The input capacitor supplies the driver currents during MOSFET switching and can have relatively large spikes. Connecting the capacitor close to the device will reduce the inductance between  $C_{IN}$  and the LM3528 and eliminate much of the noise that can disturb the internal analog circuitry.

2, Connect the anode of the Schottky diode as close to the SW pin as possible. This reduces the inductance between the internal MOSFET and the diode and minimizes the noise generated from the discontinuous diode current and the PCB trace inductance that will add ringing at the SW node and filter through to VOUT. This is especially important in VOUT mode when designing for a stable output voltage.

3,  $C_{OUT}$  should be located on the top layer to minimize the trace lengths between the diode and PGND. Connect the positive terminal of the output capacitor ( $C_{OUT+}$ ) as close as possible to the cathode of the diode. Connect the negative terminal of the output capacitor ( $C_{OUT-}$ ) as close as possible

to the PGND pin on the LM3528. This minimizes the inductance in series with the output capacitor and reduces the noise present at VOUT and at the PGND connection. This is important due to the large  $di/dt$  into and out of  $C_{OUT}$ . The returns for both  $C_{IN}$  and  $C_{OUT}$  should terminate directly to the PGND pin.

4, Connect the inductor on the top layer close to the SW pin. There should be a low impedance connection from the inductor to SW due to the large DC inductor current, and at the same time the area occupied by the SW node should be small so as to reduce the capacitive coupling of the high  $dV/dt$  present at SW that can couple into nearby traces.

5, Route the traces for  $R_{SET}$  and the feedback divider away from the SW node to minimize the capacitance between these nodes that can couple the high  $dV/dt$  present at SW into them. Furthermore, the feedback divider and  $R_{SET}$  should have dedicated returns that terminate directly to the PGND pin of the device. This will minimize any shared current with  $C_{OUT}$  or  $C_{IN}$  that can lead to instability. Avoid routing the SUB/FB node close to other traces that can see high  $dV/dt$  such as the I2C pins. The capacitive coupling on the PCB between FB and these nodes can disturb the output voltage and cause large voltage spikes at VOUT.

6, Do not connect any external capacitance to the SET pin.

7, Refer to the LM3528 Evaluation Board as a guide for proper layout.

**Physical Dimensions** inches (millimeters) unless otherwise noted

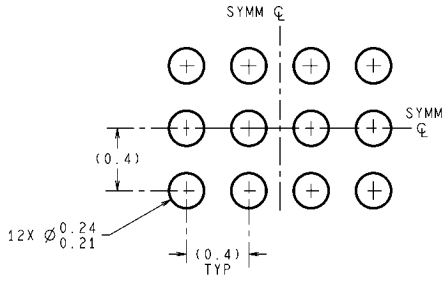

**DIMENSIONS ARE IN MILLIMETERS**  
DIMENSIONS IN ( ) FOR REFERENCE ONLY

**LAND PATTERN RECOMMENDATION**

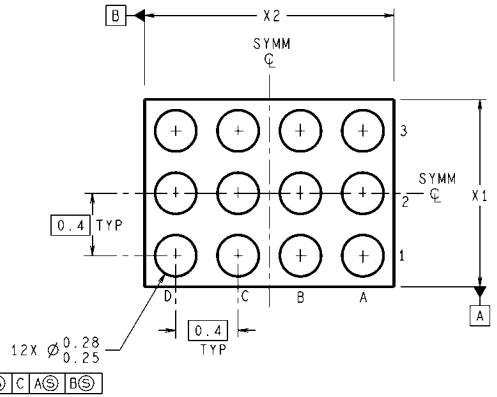
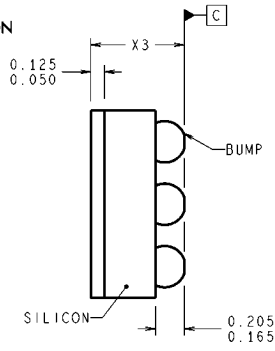
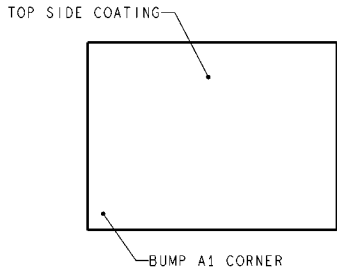

⊕ 0.005 C A B

TMD12XXX (Rev B)

**12 Bump  $\mu$ SMD**  
**For Ordering, Refer to Ordering Information Table**  
**NS Package Number TMD12**  
**X1 = 1.215mm ( $\pm$ 0.1mm), X2 = 1.615mm ( $\pm$ 0.1mm), X3 = 0.6mm**

# Notes

LM3528



## Notes

For more National Semiconductor product information and proven design tools, visit the following Web sites at:

Products		Design Support	
Amplifiers	<a href="http://www.national.com/amplifiers">www.national.com/amplifiers</a>	WEBENCH	<a href="http://www.national.com/webench">www.national.com/webench</a>
Audio	<a href="http://www.national.com/audio">www.national.com/audio</a>	Analog University	<a href="http://www.national.com/AU">www.national.com/AU</a>
Clock Conditioners	<a href="http://www.national.com/timing">www.national.com/timing</a>	App Notes	<a href="http://www.national.com/appnotes">www.national.com/appnotes</a>
Data Converters	<a href="http://www.national.com/adc">www.national.com/adc</a>	Distributors	<a href="http://www.national.com/contacts">www.national.com/contacts</a>
Displays	<a href="http://www.national.com/displays">www.national.com/displays</a>	Green Compliance	<a href="http://www.national.com/quality/green">www.national.com/quality/green</a>
Ethernet	<a href="http://www.national.com/ethernet">www.national.com/ethernet</a>	Packaging	<a href="http://www.national.com/packaging">www.national.com/packaging</a>
Interface	<a href="http://www.national.com/interface">www.national.com/interface</a>	Quality and Reliability	<a href="http://www.national.com/quality">www.national.com/quality</a>
LVDS	<a href="http://www.national.com/lvds">www.national.com/lvds</a>	Reference Designs	<a href="http://www.national.com/refdesigns">www.national.com/refdesigns</a>
Power Management	<a href="http://www.national.com/power">www.national.com/power</a>	Feedback	<a href="http://www.national.com/feedback">www.national.com/feedback</a>
Switching Regulators	<a href="http://www.national.com/switchers">www.national.com/switchers</a>		
LDOs	<a href="http://www.national.com/lido">www.national.com/lido</a>		
LED Lighting	<a href="http://www.national.com/led">www.national.com/led</a>		
PowerWise	<a href="http://www.national.com/powerwise">www.national.com/powerwise</a>		
Serial Digital Interface (SDI)	<a href="http://www.national.com/sdi">www.national.com/sdi</a>		
Temperature Sensors	<a href="http://www.national.com/tempsensors">www.national.com/tempsensors</a>		
Wireless (PLL/VCO)	<a href="http://www.national.com/wireless">www.national.com/wireless</a>		

THE CONTENTS OF THIS DOCUMENT ARE PROVIDED IN CONNECTION WITH NATIONAL SEMICONDUCTOR CORPORATION ("NATIONAL") PRODUCTS. NATIONAL MAKES NO REPRESENTATIONS OR WARRANTIES WITH RESPECT TO THE ACCURACY OR COMPLETENESS OF THE CONTENTS OF THIS PUBLICATION AND RESERVES THE RIGHT TO MAKE CHANGES TO SPECIFICATIONS AND PRODUCT DESCRIPTIONS AT ANY TIME WITHOUT NOTICE. NO LICENSE, WHETHER EXPRESS, IMPLIED, ARISING BY ESTOPPEL OR OTHERWISE, TO ANY INTELLECTUAL PROPERTY RIGHTS IS GRANTED BY THIS DOCUMENT.

TESTING AND OTHER QUALITY CONTROLS ARE USED TO THE EXTENT NATIONAL DEEMS NECESSARY TO SUPPORT NATIONAL'S PRODUCT WARRANTY. EXCEPT WHERE MANDATED BY GOVERNMENT REQUIREMENTS, TESTING OF ALL PARAMETERS OF EACH PRODUCT IS NOT NECESSARILY PERFORMED. NATIONAL ASSUMES NO LIABILITY FOR APPLICATIONS ASSISTANCE OR BUYER PRODUCT DESIGN. BUYERS ARE RESPONSIBLE FOR THEIR PRODUCTS AND APPLICATIONS USING NATIONAL COMPONENTS. PRIOR TO USING OR DISTRIBUTING ANY PRODUCTS THAT INCLUDE NATIONAL COMPONENTS, BUYERS SHOULD PROVIDE ADEQUATE DESIGN, TESTING AND OPERATING SAFEGUARDS.

EXCEPT AS PROVIDED IN NATIONAL'S TERMS AND CONDITIONS OF SALE FOR SUCH PRODUCTS, NATIONAL ASSUMES NO LIABILITY WHATSOEVER, AND NATIONAL DISCLAIMS ANY EXPRESS OR IMPLIED WARRANTY RELATING TO THE SALE AND/OR USE OF NATIONAL PRODUCTS INCLUDING LIABILITY OR WARRANTIES RELATING TO FITNESS FOR A PARTICULAR PURPOSE, MERCHANTABILITY, OR INFRINGEMENT OF ANY PATENT, COPYRIGHT OR OTHER INTELLECTUAL PROPERTY RIGHT.

### LIFE SUPPORT POLICY

**NATIONAL'S PRODUCTS ARE NOT AUTHORIZED FOR USE AS CRITICAL COMPONENTS IN LIFE SUPPORT DEVICES OR SYSTEMS WITHOUT THE EXPRESS PRIOR WRITTEN APPROVAL OF THE CHIEF EXECUTIVE OFFICER AND GENERAL COUNSEL OF NATIONAL SEMICONDUCTOR CORPORATION.** As used herein:

Life support devices or systems are devices which (a) are intended for surgical implant into the body, or (b) support or sustain life and whose failure to perform when properly used in accordance with instructions for use provided in the labeling can be reasonably expected to result in a significant injury to the user. A critical component is any component in a life support device or system whose failure to perform can be reasonably expected to cause the failure of the life support device or system or to affect its safety or effectiveness.

National Semiconductor and the National Semiconductor logo are registered trademarks of National Semiconductor Corporation. All other brand or product names may be trademarks or registered trademarks of their respective holders.

Copyright© 2008 National Semiconductor Corporation

For the most current product information visit us at [www.national.com](http://www.national.com)



**National Semiconductor Americas Technical Support Center**  
 Email: [support@nsc.com](mailto:support@nsc.com)  
 Tel: 1-800-272-9959

**National Semiconductor Europe Technical Support Center**  
 Email: [europe.support@nsc.com](mailto:europe.support@nsc.com)  
 German Tel: +49 (0) 180 5010 771  
 English Tel: +44 (0) 870 850 4288

**National Semiconductor Asia Pacific Technical Support Center**  
 Email: [ap.support@nsc.com](mailto:ap.support@nsc.com)

**National Semiconductor Japan Technical Support Center**  
 Email: [jpn.feedback@nsc.com](mailto:jpn.feedback@nsc.com)

## IMPORTANT NOTICE

Texas Instruments Incorporated and its subsidiaries (TI) reserve the right to make corrections, modifications, enhancements, improvements, and other changes to its products and services at any time and to discontinue any product or service without notice. Customers should obtain the latest relevant information before placing orders and should verify that such information is current and complete. All products are sold subject to TI's terms and conditions of sale supplied at the time of order acknowledgment.

TI warrants performance of its hardware products to the specifications applicable at the time of sale in accordance with TI's standard warranty. Testing and other quality control techniques are used to the extent TI deems necessary to support this warranty. Except where mandated by government requirements, testing of all parameters of each product is not necessarily performed.

TI assumes no liability for applications assistance or customer product design. Customers are responsible for their products and applications using TI components. To minimize the risks associated with customer products and applications, customers should provide adequate design and operating safeguards.

TI does not warrant or represent that any license, either express or implied, is granted under any TI patent right, copyright, mask work right, or other TI intellectual property right relating to any combination, machine, or process in which TI products or services are used. Information published by TI regarding third-party products or services does not constitute a license from TI to use such products or services or a warranty or endorsement thereof. Use of such information may require a license from a third party under the patents or other intellectual property of the third party, or a license from TI under the patents or other intellectual property of TI.

Reproduction of TI information in TI data books or data sheets is permissible only if reproduction is without alteration and is accompanied by all associated warranties, conditions, limitations, and notices. Reproduction of this information with alteration is an unfair and deceptive business practice. TI is not responsible or liable for such altered documentation. Information of third parties may be subject to additional restrictions.

Resale of TI products or services with statements different from or beyond the parameters stated by TI for that product or service voids all express and any implied warranties for the associated TI product or service and is an unfair and deceptive business practice. TI is not responsible or liable for any such statements.

TI products are not authorized for use in safety-critical applications (such as life support) where a failure of the TI product would reasonably be expected to cause severe personal injury or death, unless officers of the parties have executed an agreement specifically governing such use. Buyers represent that they have all necessary expertise in the safety and regulatory ramifications of their applications, and acknowledge and agree that they are solely responsible for all legal, regulatory and safety-related requirements concerning their products and any use of TI products in such safety-critical applications, notwithstanding any applications-related information or support that may be provided by TI. Further, Buyers must fully indemnify TI and its representatives against any damages arising out of the use of TI products in such safety-critical applications.

TI products are neither designed nor intended for use in military/aerospace applications or environments unless the TI products are specifically designated by TI as military-grade or "enhanced plastic." Only products designated by TI as military-grade meet military specifications. Buyers acknowledge and agree that any such use of TI products which TI has not designated as military-grade is solely at the Buyer's risk, and that they are solely responsible for compliance with all legal and regulatory requirements in connection with such use.

TI products are neither designed nor intended for use in automotive applications or environments unless the specific TI products are designated by TI as compliant with ISO/TS 16949 requirements. Buyers acknowledge and agree that, if they use any non-designated products in automotive applications, TI will not be responsible for any failure to meet such requirements.

Following are URLs where you can obtain information on other Texas Instruments products and application solutions:

### Products

Audio	<a href="http://www.ti.com/audio">www.ti.com/audio</a>
Amplifiers	<a href="http://amplifier.ti.com">amplifier.ti.com</a>
Data Converters	<a href="http://dataconverter.ti.com">dataconverter.ti.com</a>
DLP® Products	<a href="http://www.dlp.com">www.dlp.com</a>
DSP	<a href="http://dsp.ti.com">dsp.ti.com</a>
Clocks and Timers	<a href="http://www.ti.com/clocks">www.ti.com/clocks</a>
Interface	<a href="http://interface.ti.com">interface.ti.com</a>
Logic	<a href="http://logic.ti.com">logic.ti.com</a>
Power Mgmt	<a href="http://power.ti.com">power.ti.com</a>
Microcontrollers	<a href="http://microcontroller.ti.com">microcontroller.ti.com</a>
RFID	<a href="http://www.ti-rfid.com">www.ti-rfid.com</a>
OMAP Mobile Processors	<a href="http://www.ti.com/omap">www.ti.com/omap</a>
Wireless Connectivity	<a href="http://www.ti.com/wirelessconnectivity">www.ti.com/wirelessconnectivity</a>

### Applications

Communications and Telecom	<a href="http://www.ti.com/communications">www.ti.com/communications</a>
Computers and Peripherals	<a href="http://www.ti.com/computers">www.ti.com/computers</a>
Consumer Electronics	<a href="http://www.ti.com/consumer-apps">www.ti.com/consumer-apps</a>
Energy and Lighting	<a href="http://www.ti.com/energy">www.ti.com/energy</a>
Industrial	<a href="http://www.ti.com/industrial">www.ti.com/industrial</a>
Medical	<a href="http://www.ti.com/medical">www.ti.com/medical</a>
Security	<a href="http://www.ti.com/security">www.ti.com/security</a>
Space, Avionics and Defense	<a href="http://www.ti.com/space-avionics-defense">www.ti.com/space-avionics-defense</a>
Transportation and Automotive	<a href="http://www.ti.com/automotive">www.ti.com/automotive</a>
Video and Imaging	<a href="http://www.ti.com/video">www.ti.com/video</a>

TI E2E Community Home Page

[e2e.ti.com](http://e2e.ti.com)

Mailing Address: Texas Instruments, Post Office Box 655303, Dallas, Texas 75265  
Copyright © 2011, Texas Instruments Incorporated