

# 2MHz, High-Brightness LED Drivers with Integrated MOSFET and High-Side Current Sense

## General Description

The MAX16822A/MAX16822B step-down constant-current high-brightness LED (HB LED) drivers provide a cost-effective design solution for automotive interior/exterior lighting, architectural and ambient lighting, LED bulbs, and other LED illumination applications.

The MAX16822A/MAX16822B operate from a +6.5V to +65V input-voltage range and can provide an output current up to 350mA, if operated up to a temperature of +125°C, or up to 500mA, if operated up to a temperature of +105°C. A high-side current-sense resistor adjusts the output current and a dedicated pulse-width modulation (PWM) input enables pulsed LED dimming over a wide range of brightness levels.

These devices are well suited for applications requiring a wide input-voltage range. The high-side current sensing and an integrated current-setting circuitry minimize the number of external components while delivering an average output current with  $\pm 3\%$  accuracy. A hysteretic control method ensures excellent input supply rejection and fast response during load transients and PWM dimming. The MAX16822A allows 10% current ripple and the MAX16822B allows 30% current ripple. Both devices operate up to a switching frequency of 2MHz, thus allowing the use of small-sized components.

The MAX16822A/MAX16822B offer an analog dimming feature that reduces the output current by applying an external DC voltage below the internal 2V threshold voltage from TEMP\_I to GND. TEMP\_I also sources 25 $\mu$ A to a negative temperature coefficient (NTC) thermistor connected between TEMP\_I and GND, thus providing an analog thermal-foldback feature that reduces the LED current when the temperature of the LED string exceeds a specified temperature point.

An additional feature includes thermal-shutdown protection that turns off the LX driver when the junction temperature exceeds +165°C.

The MAX16822A/MAX16822B operate over the -40°C to +125°C automotive temperature range and are available in an 8-pin SO package.

## Applications

Architectural, Industrial, and Ambient Lighting  
Automotive RCL, DRL, and Fog Lights  
Heads-Up Displays  
Indicator and Emergency Lighting

Pin Configuration appears at end of data sheet.

## Features

- ◆ High-Efficiency Solution
- ◆ 6.5V to 65V Input-Voltage Range
- ◆ Output Current Up to 500mA
- ◆ On-Board 65V, 0.85 $\Omega$  Power MOSFET
- ◆ Hysteretic Control: Up to 2MHz Switching Frequency
- ◆  $\pm 3\%$  LED Current Accuracy
- ◆ 200mV Current-Sense Reference
- ◆ Resistor-Programmable Constant LED Current
- ◆ Integrated High-Side Current Sense
- ◆ Thermal-Foldback Protection/Linear Dimming
- ◆ Thermal-Shutdown Protection
- ◆ Available in an 8-Pin SO Package
- ◆ -40°C to +125°C Operating Temperature Range

## Ordering Information

PART	TEMP RANGE	PIN-PACKAGE
MAX16822AASA+	-40°C to +125°C	8 SO
MAX16822AASA/V+	-40°C to +125°C	8 SO
MAX16822BASA+	-40°C to +125°C	8 SO

+ Denotes a lead(Pb)-free/RoHS-compliant package.  
/V denotes an automotive qualified part.

## Typical Application Circuit

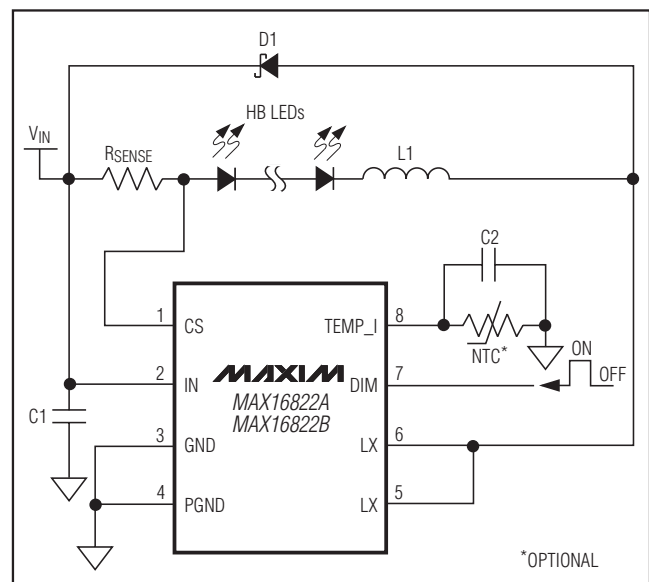

# 2MHz, High-Brightness LED Drivers with Integrated MOSFET and High-Side Current Sense

## ABSOLUTE MAXIMUM RATINGS

IN, CS, LX, DIM to GND .....	-0.3V to +70V
TEMP_I to GND .....	-0.3V to +6V
PGND to GND .....	-0.3V to +0.3V
CS to IN .....	-0.3V to +0.3V
Maximum Current into Any Pin (except IN, LX, and PGND).....	20mA
Continuous Power Dissipation (T <sub>A</sub> = +70°C) 8-Pin SO (derate 7.4mW/°C above +70°C).....	588.2mW

Junction-to-Ambient Thermal Resistance (θ <sub>JA</sub> ) (Note 1)...	136°C/W
Pin-to-Pin ESD Ratings.....	±2.5kV
Operating Temperature Range	
350mA (max) Output Current .....	-40°C to +125°C
500mA (max) Output Current .....	-40°C to +105°C
Junction Temperature .....	+150°C
Storage Temperature Range .....	-65°C to +150°C
Lead Temperature (soldering, 10s).....	+300°C

**Note 1:** Package thermal resistances were obtained using the method described in JEDEC specification JESD51-7, using a four-layer board. For detailed information on package thermal considerations, see [www.maxim-ic.com/thermal-tutorial](http://www.maxim-ic.com/thermal-tutorial).

Stresses beyond those listed under "Absolute Maximum Ratings" may cause permanent damage to the device. These are stress ratings only, and functional operation of the device at these or any other conditions beyond those indicated in the operational sections of the specifications is not implied. Exposure to absolute maximum rating conditions for extended periods may affect device reliability.

## ELECTRICAL CHARACTERISTICS

(V<sub>IN</sub> = +24V, V<sub>DIM</sub> = V<sub>IN</sub>, T<sub>A</sub> = T<sub>J</sub> = -40°C to +125°C, unless otherwise noted. Typical values are at T<sub>A</sub> = +25°C.)

PARAMETER	SYMBOL	CONDITIONS	MIN	TYP	MAX	UNITS
Input-Voltage Range	V <sub>IN</sub>		6.5		65	V
Ground Current		No switching		1.5		mA
Supply Current		V <sub>DIM</sub> < 0.6V, V <sub>IN</sub> = 12V		350		μA
<b>UNDERVOLTAGE LOCKOUT (UVLO)</b>						
Undervoltage Lockout	UVLO	V <sub>CS</sub> = V <sub>IN</sub> - 100mV, V <sub>IN</sub> rising from 4V until V <sub>LX</sub> < 0.5V <sub>IN</sub>		6.25	6.5	V
		V <sub>CS</sub> = V <sub>IN</sub> - 100mV, V <sub>IN</sub> falling from 6.5V until V <sub>LX</sub> > 0.5V <sub>IN</sub>			6	
Undervoltage-Lockout Hysteresis				0.5		V
<b>SENSE COMPARATOR</b>						
Sense Voltage Threshold High	V <sub>SNSHI</sub>	MAX16822A, V <sub>IN</sub> - V <sub>CS</sub> rising from 140mV until V <sub>LX</sub> > 0.5V <sub>IN</sub>	201	210	216	mV
		MAX16822B, V <sub>IN</sub> - V <sub>CS</sub> rising from 140mV until V <sub>LX</sub> > 0.5V <sub>IN</sub>	218	230	236	
Sense Voltage Threshold Low	V <sub>SNSLO</sub>	MAX16822A, V <sub>IN</sub> - V <sub>CS</sub> falling from 260mV until V <sub>LX</sub> < 0.5V <sub>IN</sub>	185	190	198	mV
		MAX16822B, V <sub>IN</sub> - V <sub>CS</sub> falling from 260mV until V <sub>LX</sub> < 0.5V <sub>IN</sub>	166	170	180	
Propagation Delay to Output High	t <sub>DPDH</sub>	Falling edge of V <sub>IN</sub> - V <sub>CS</sub> from 140mV to 260mV to V <sub>LX</sub> > 0.5V <sub>IN</sub>		50		ns
Propagation Delay to Output Low	t <sub>DPDL</sub>	Rising edge of V <sub>CS</sub> - V <sub>IN</sub> from 260mV to 140mV to V <sub>LX</sub> < 0.5V <sub>IN</sub>		50		ns
CS Input Current	I <sub>CSIN</sub>	V <sub>IN</sub> - V <sub>CS</sub> = 200mV			3.5	μA

# 2MHz, High-Brightness LED Drivers with Integrated MOSFET and High-Side Current Sense

## ELECTRICAL CHARACTERISTICS (continued)

( $V_{IN} = +24V$ ,  $V_{DIM} = V_{IN}$ ,  $T_A = T_J = -40^{\circ}C$  to  $+125^{\circ}C$ , unless otherwise noted. Typical values are at  $T_A = +25^{\circ}C$ .)

PARAMETER	SYMBOL	CONDITIONS	MIN	TYP	MAX	UNITS
<b>INTERNAL MOSFET</b>						
Drain-to-Source Resistance	RDSON	$V_{IN} = V_{DIM} = 24V$ , $V_{CS} = 23.9V$ , $I_{LX} = 350mA$		0.85	1.7	$\Omega$
		$V_{IN} = V_{DIM} = 6.0V$ , $V_{CS} = 5.9V$ , $I_{LX} = 350mA$		1	2	
LX Leakage Current	I <sub>LX_LEAK</sub>	$V_{DIM} = 0V$ , $V_{LX} = 65V$			10	$\mu A$
<b>DIM INPUT</b>						
DIM Input-Voltage High	V <sub>IH</sub>	$V_{IN} - V_{CS} = 100mV$	2.8			V
DIM Input-Voltage Low	V <sub>IL</sub>	$V_{CS} - V_{IN} = 100mV$			0.6	V
DIM Turn-On Time	t <sub>DIM_ON</sub>	$V_{DIM}$ rising edge to $V_{LX} < 0.5V_{IN}$		200		ns
DIM Input Leakage High		$V_{DIM} = V_{IN}$			15	$\mu A$
DIM Input Leakage Low		$V_{DIM} = 0V$	-3		0	$\mu A$
<b>THERMAL SHUTDOWN</b>						
Thermal-Shutdown Threshold		Temperature rising		165		$^{\circ}C$
Thermal-Shutdown Threshold Hysteresis				10		$^{\circ}C$
<b>THERMAL FOLDBACK</b>						
Thermal-Foldback Enable Threshold Voltage	V <sub>TFB_ON</sub>	$V_{DIM} = 5V$	1.9	2.0	2.12	V
Thermal-Foldback Slope	FBSLOPE	$V_{DIM} = 5V$		0.75		1/V
TEMP_I Output Bias Current	I <sub>TEMP_I</sub>		25	26.5	28	$\mu A$

## Typical Operating Characteristics

( $V_{IN} = V_{DIM} = 48V$ ,  $C_{VCC} = 1\mu F$ ,  $R_{SENSE} = 0.62\Omega$ ,  $L = 220\mu H$  (connected between IN and CS). Typical values are at  $T_A = +25^{\circ}C$ , unless otherwise noted.)

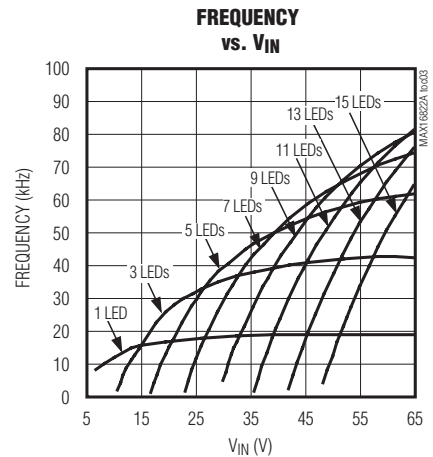
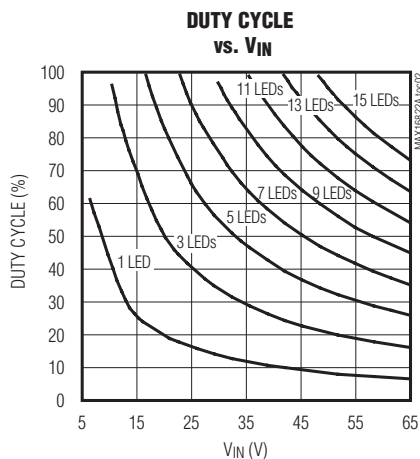
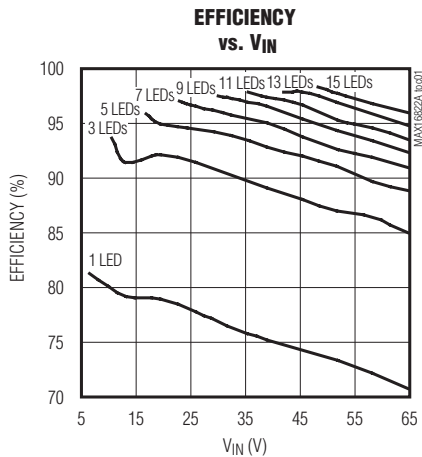

# 2MHz, High-Brightness LED Drivers with Integrated MOSFET and High-Side Current Sense

## Typical Operating Characteristics (continued)

( $V_{IN} = V_{DIM} = 48V$ ,  $C_{VCC} = 1\mu F$ ,  $R_{SENSE} = 0.62\Omega$ ,  $L = 220\mu H$  (connected between IN and CS). Typical values are at  $T_A = +25^\circ C$ , unless otherwise noted.)

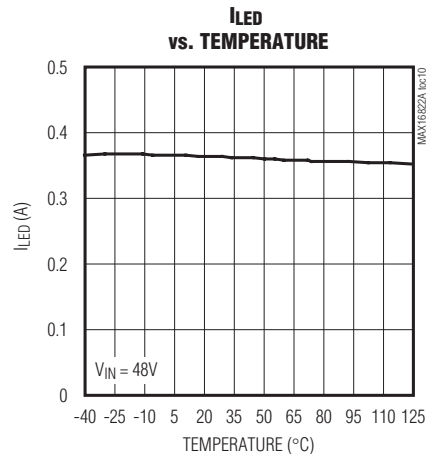
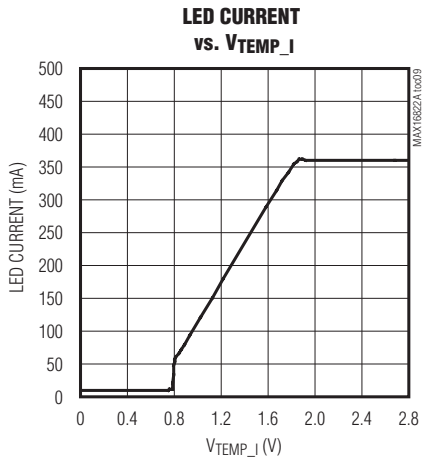
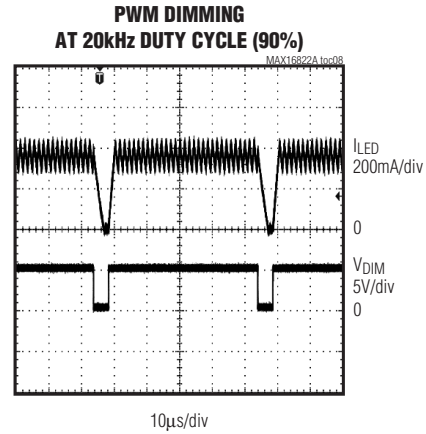
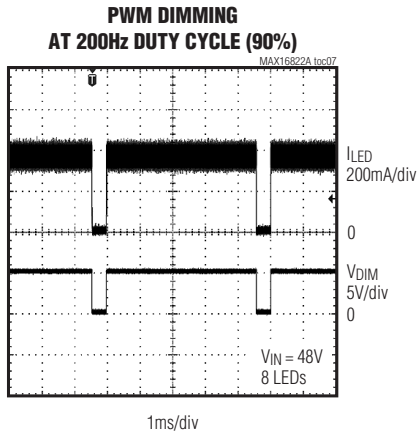
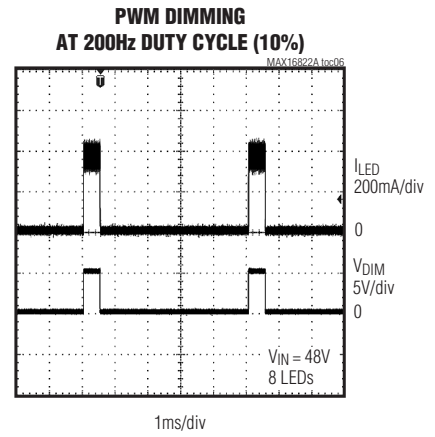
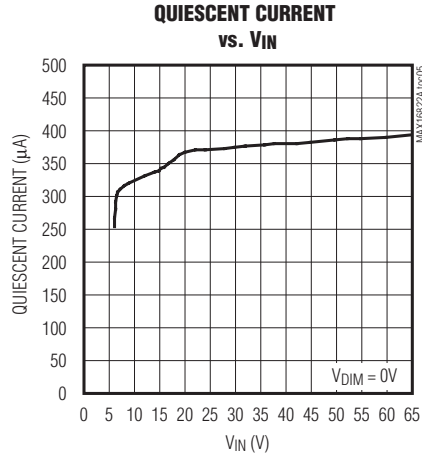
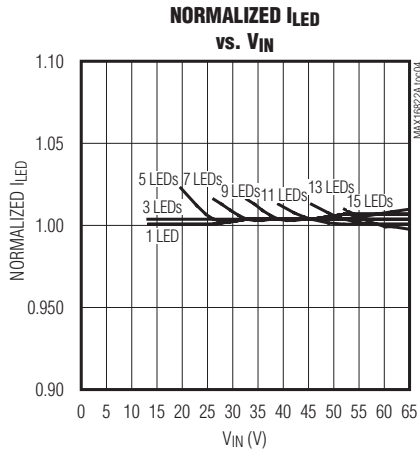

# 2MHz, High-Brightness LED Drivers with Integrated MOSFET and High-Side Current Sense

## Typical Operating Characteristics (continued)

( $V_{IN} = V_{DIM} = 48V$ ,  $C_{VCC} = 1\mu F$ ,  $R_{SENSE} = 0.62\Omega$ ,  $L = 220\mu H$  (connected between IN and CS). Typical values are at  $T_A = +25^\circ C$ , unless otherwise noted.)

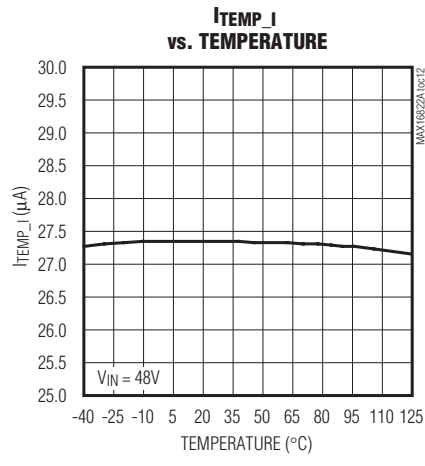
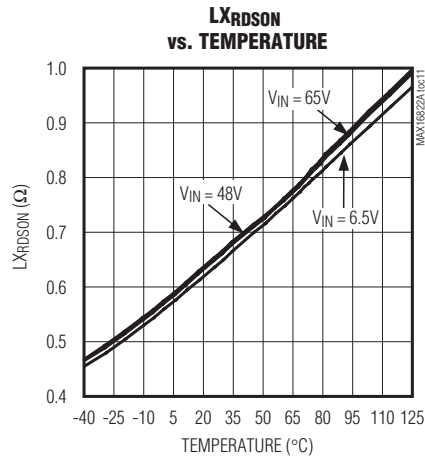

## Pin Description

PIN	NAME	FUNCTION
1	CS	Current-Sense Input. Connect a resistor between IN and CS to program the LED current.
2	IN	Positive Supply Voltage Input. Bypass with a 1μF or higher value capacitor to GND.
3	GND	Ground
4	PGND	Power Ground
5, 6	LX	Switching Node
7	DIM	Logic-Level Dimming Input. Drive DIM low to turn off the current regulator. Drive DIM high to enable the current regulator.
8	TEMP_I	Thermal Foldback Control and Linear Input. Bypass with a 0.01μF capacitor to GND if thermal foldback or analog dimming is used. See the <i>Thermal Foldback</i> section for more details.

## Detailed Description

The MAX16822A/MAX16822B are step-down, constant-current, high-brightness LED (HB LED) drivers. These devices operate from a +6.5V to +65V input-voltage range. The maximum output current is 500mA, if the part is used at temperatures up to +105°C, or 350mA, if it is used up to +125°C. A high-side current-sense resistor sets the output current and a dedicated PWM

dimming input enables pulsed LED dimming over a wide range of brightness levels.

A high-side current-sensing scheme and an on-board current-setting circuitry minimize the number of external components while delivering LED current with ±3% accuracy, using a 1% sense resistor. See Figure 1 for an internal block diagram.

# 2MHz, High-Brightness LED Drivers with Integrated MOSFET and High-Side Current Sense

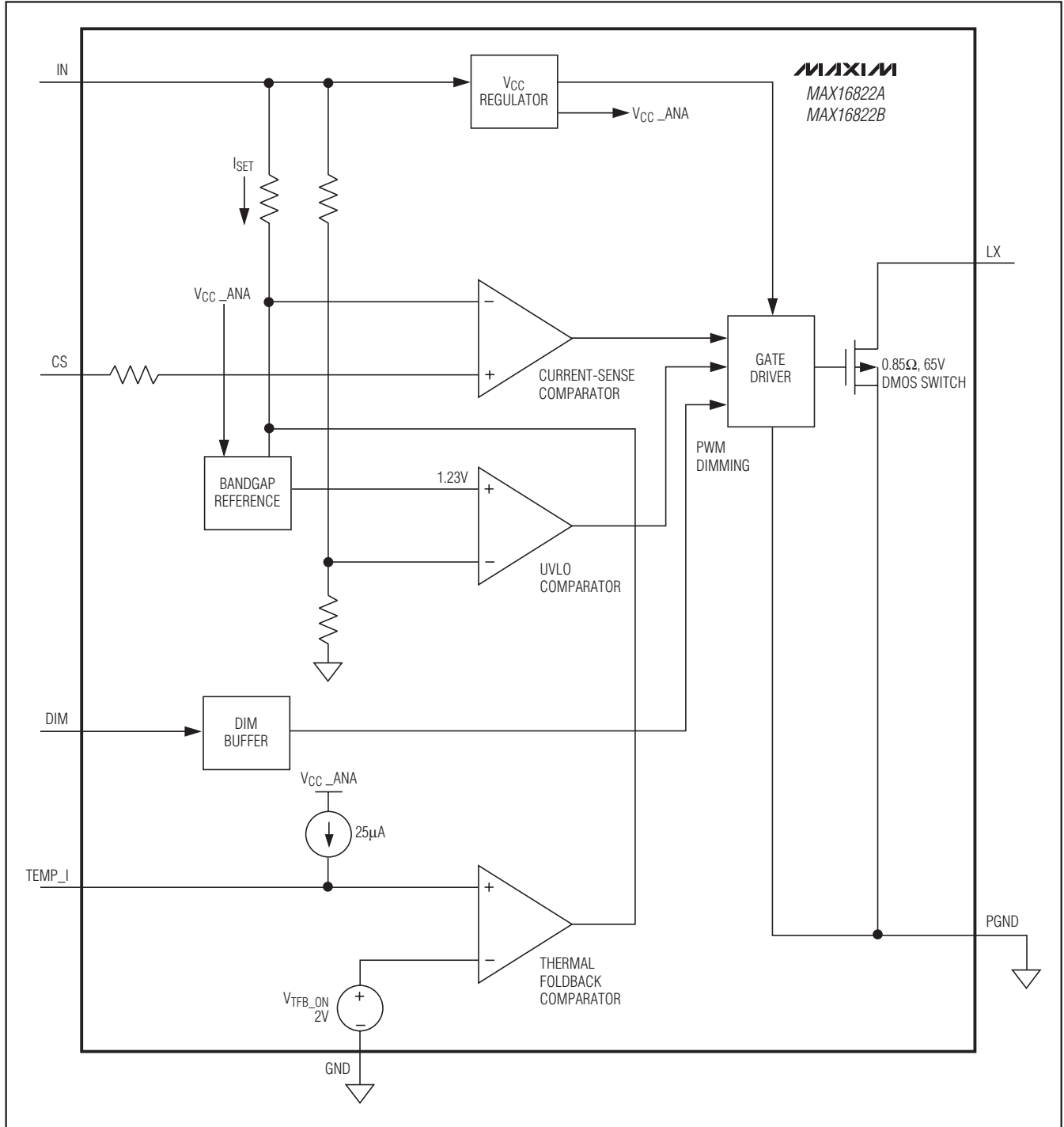

Figure 1. Internal Block Diagram

# 2MHz, High-Brightness LED Drivers with Integrated MOSFET and High-Side Current Sense

## Undervoltage Lockout (UVLO)

The MAX16822A/MAX16822B include UVLO with 500mV hysteresis. The internal MOSFET turns off when  $V_{IN}$  falls below 5.5V to 6.0V.

## DIM Input

LED dimming is achieved by applying a PWM signal at DIM. A logic level below 0.6V at DIM forces the MAX16822A/MAX16822B's output low, thus turning off the LED current. To turn the LED current on, the logic level at DIM must be greater than 2.8V.

## Thermal Shutdown

The MAX16822A/MAX16822B thermal-shutdown feature turns off the LX driver when the junction temperature exceeds +165°C. The LX driver turns back on when the junction temperature drops 10°C below the shutdown-temperature threshold.

## Analog Dimming

The MAX16822A/MAX16822B offer an analog dimming feature that reduces the output current when the voltage at TEMP\_I is below the internal 2V threshold voltage. The MAX16822A/MAX16822B achieve analog dimming by either an external DC voltage source connected between TEMP\_I and ground or by a voltage on a resistor connected across TEMP\_I and ground induced by an internal current source of 25µA. When the voltage at TEMP\_I is below the internal 2V threshold limit, the MAX16822A/MAX16822B reduce the LED current. Use the following formula to set the analog dimming current.

$$I_{TF}(A) = I_{LED}(A) \times \left[ 1 - FB_{SLOPE} \left( \frac{1}{V} \right) \times (V_{TFB\_ON} - V_{AD})(V) \right]$$

where  $V_{TFB\_ON} = 2V$  and  $FB_{SLOPE} = 0.75$  are obtained from the *Electrical Characteristics* table and  $V_{AD}$  is the voltage at TEMP\_I.

## Thermal Foldback

The MAX16822A/MAX16822B also include a thermal-foldback feature that reduces the output current when the temperature of the LED string exceeds a specified temperature point. These devices enter thermal-foldback mode when the voltage drop on the NTC thermistor, thermally attached to the LEDs and electrically connected between TEMP\_I and ground, drops below the internal 2V threshold limit.

## Applications Information

### Selecting R<sub>SENSE</sub> to Set LED Current

The LED current is programmed with a current-sense resistor connected between IN and CS. Use the equation below to calculate the value of this resistor:

$$R_{SENSE}(\Omega) = \frac{1}{2} \frac{(V_{SNSHI} + V_{SNSLO})(V)}{I_{LED}(A)}$$

where  $V_{SNSHI}$  is the sense voltage threshold high and  $V_{SNSLO}$  is sense voltage threshold low (see the *Electrical Characteristics* table for values).

### Current-Regulator Operation

The MAX16822A/MAX16822B regulate the LED current using a comparator with hysteresis (see Figure 2). As the current through the inductor ramps up and the voltage across the sense resistor reaches the upper threshold, the internal MOSFET turns off. The internal MOSFET turns on again when the inductor current ramps down through the freewheeling diode until the voltage across the sense resistor equals the lower threshold. Use the following equation to determine the operating frequency:

$$f_{SW} = \frac{(V_{IN} - nV_{LED}) \times nV_{LED} \times R_{SENSE}}{V_{IN} \times \Delta V \times L}$$

where  $n$  is the number of LEDs,  $V_{LED}$  is the forward voltage drop of 1 LED, and  $\Delta V = (V_{SNSHI} - V_{SNSLO})$ .

### Inductor Selection

The MAX16822A/MAX16822B operate up to a switching frequency of 2MHz. For space-sensitive applications, the high switching frequency allows the size of the inductor to be reduced. Use the following formula to calculate an approximate inductor value and use the closest standard value:

$$L(\text{approx.}) = \frac{(V_{IN} - nV_{LED}) \times nV_{LED} \times R_{SENSE}}{V_{IN} \times \Delta V \times f_{SW}}$$

For component selection, use the MAX16822A/B Design Tool available at: [www.maxim-ic.com/MAX16822-software](http://www.maxim-ic.com/MAX16822-software).



## 2MHz, High-Brightness LED Drivers with Integrated MOSFET and High-Side Current Sense

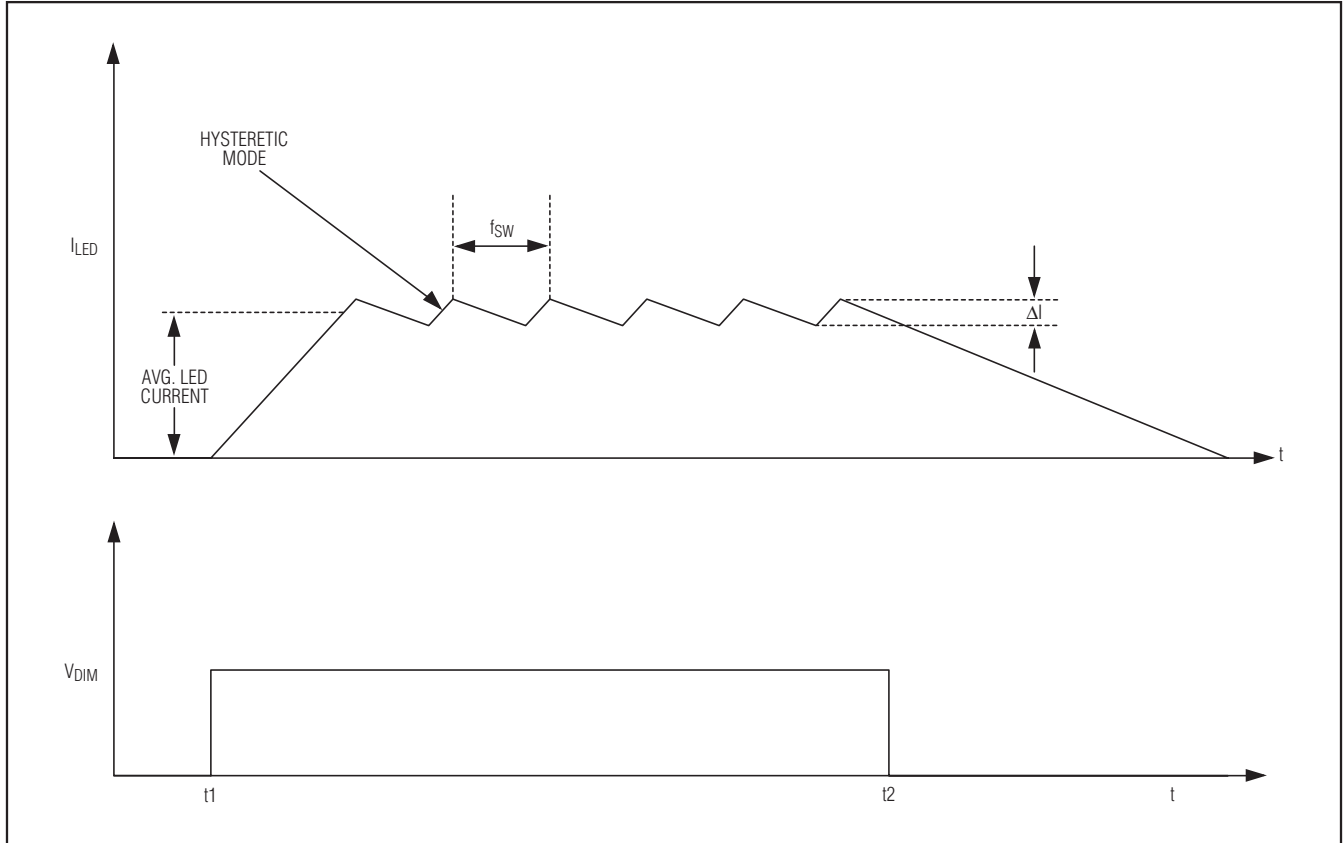

Figure 2. Current-Regulator Operation

### Freewheeling-Diode Selection

For stability and best efficiency, a low forward-voltage drop diode with fast reverse-recovery time and low capacitance is recommended. A Schottky diode is a good choice as long as its breakdown voltage is high enough to withstand the maximum operating voltage.

### PCB Layout Guidelines

Careful PCB layout is critical to achieve low switching losses and stable operation. Use a multilayer board whenever possible for better noise immunity. Minimize ground noise by connecting high-current ground returns, the input bypass-capacitor ground lead, and

the output-filter ground lead to a single point (star ground configuration). In normal operation, there are two power loops. One is formed when the internal MOSFET is on and the high current flows through IN,  $R_{SENSE}$ , LED load, the inductor, the internal MOSFET, and GND. The other loop is formed when the internal MOSFET is off and the high-current circulates through  $R_{SENSE}$ , LED load, the inductor, and the freewheeling diode. Minimize each loop area to reduce noise interaction.

Place  $R_{SENSE}$  as close as possible to CS and IN. For better noise immunity, a Kelvin connection between CS and  $R_{SENSE}$  is strongly recommended.



# 2MHz, High-Brightness LED Drivers with Integrated MOSFET and High-Side Current Sense

## Pin Configuration

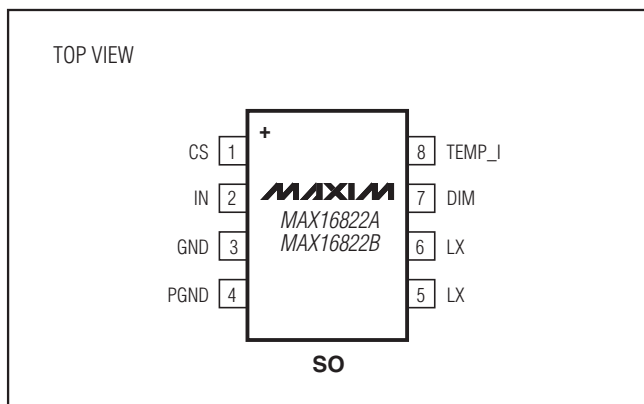

## Chip Information

PROCESS: BiCMOS

## Package Information

For the latest package outline information and land patterns, go to [www.maxim-ic.com/packages](http://www.maxim-ic.com/packages). Note that a "+", "#", or "-" in the package code indicates RoHS status only. Package drawings may show a different suffix character, but the drawing pertains to the package regardless of RoHS status.

PACKAGE TYPE	PACKAGE CODE	DOCUMENT NO.
8 SO	S8-2	<a href="#">21-0041</a>

MAX16822A/MAX16822B

# **2MHz, High-Brightness LED Drivers with Integrated MOSFET and High-Side Current Sense**

## **Revision History**

<b>REVISION NUMBER</b>	<b>REVISION DATE</b>	<b>DESCRIPTION</b>	<b>PAGES CHANGED</b>
0	5/08	Initial release	—
1	6/08	Updated <i>Ordering Information</i> table to release MAX16822B.	1
2	5/09	Revised <i>General Description, Features, Absolute Maximum Ratings, and Detailed Description</i> .	1, 2, 5
3	1/10	Added <i>N</i> part number.	1

Maxim cannot assume responsibility for use of any circuitry other than circuitry entirely embodied in a Maxim product. No circuit patent licenses are implied. Maxim reserves the right to change the circuitry and specifications without notice at any time.

10 **Maxim Integrated Products, 120 San Gabriel Drive, Sunnyvale, CA 94086 408-737-7600**