

restarting your program. Removing the PropSTICK from a solderless breadboard is a little tricky. Be sure to use the "extractor" provided and not a metal implement like a screwdriver. Working from the sides, as shown in the photo below, gently pry a little bit at a time on alternate sides until it's free.

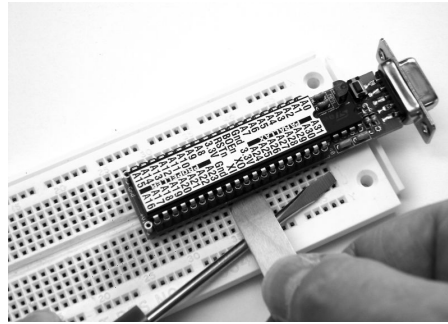

### Sample Programs

Any program written for the Propeller will, of course, work with the PropSTICK. Sample programs for the PropSTICK can be downloaded at:

[www.parallax.com/detail.asp?product\\_id=32310](http://www.parallax.com/detail.asp?product_id=32310)

Assuming everything checks out, peel the label off its backing and, starting from one end, roll it onto the back of the Propeller chip, pressing out any air bubbles as you go along. Make sure the semicircular cutout on the label aligns with its mate on the IC. Now, with the power off, insert the Propeller chip into its socket on the PropSTICK, making sure that pin 1 aligns with the "1" on the board. Connect an RS232 cable between the DB9 and your PC, and start the Propeller IDE. Power up the PropSTICK. Then press the F7 key. You should see a message indicating that the Propeller was found. When programming the Propeller, you can upload either to RAM or EEPROM. In the latter case, the reset button on the PropSTICK will come in handy for



**NOTE:** Although the PropSTICK's Vin supply can range from +5V to +9V, the Propeller chip's pins should *never* have more than 3.3V applied to them.

### PropSTICK Schematic

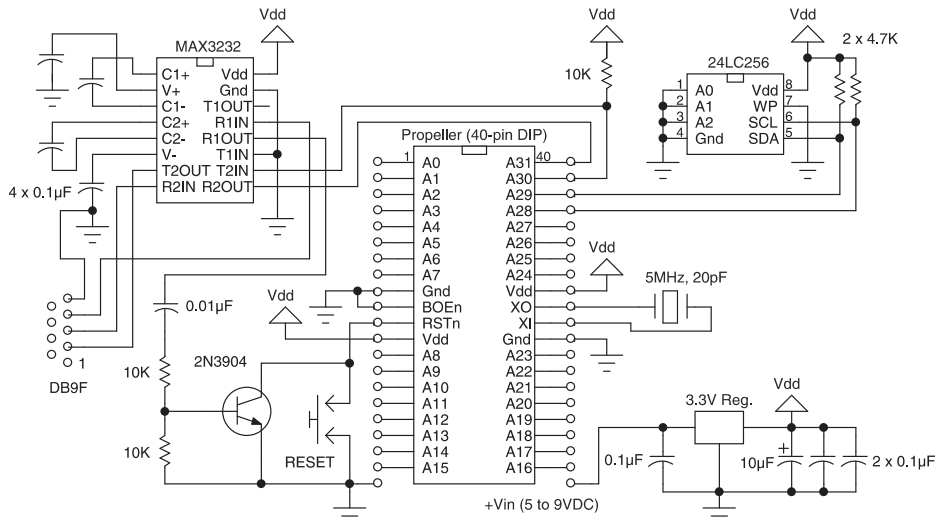

# PropSTICK Kit



Cat. No. 32310

[www.parallax.com](http://www.parallax.com)  
[support@parallax.com](mailto:support@parallax.com)

Shown Assembled, with  
 Solderless Breadboard  
 (Not Included)

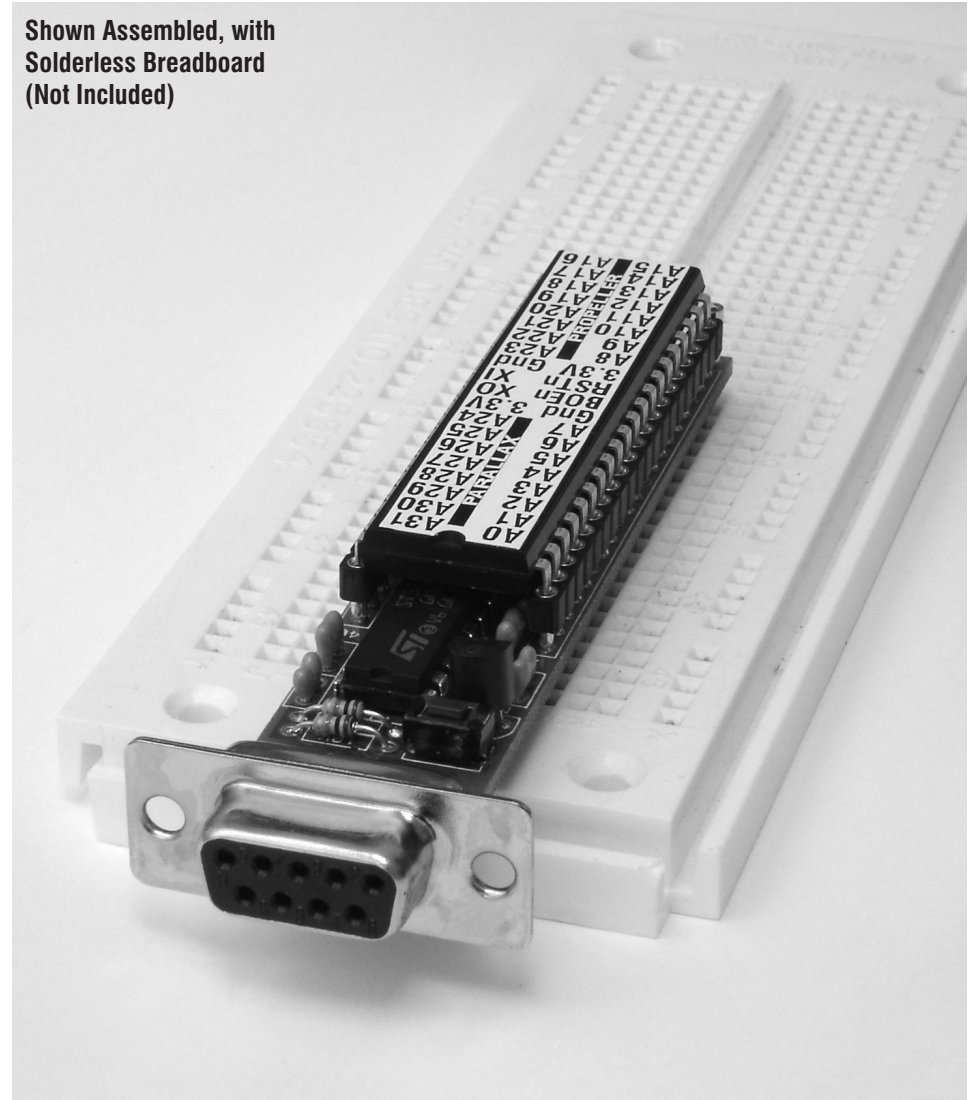

599 Menlo Drive, Suite 100 • Rocklin, CA 95765 • USA  
 888-512-1024 (toll-free) • 916-624-8333 • 916-624-8003 (fax)

## Parts List

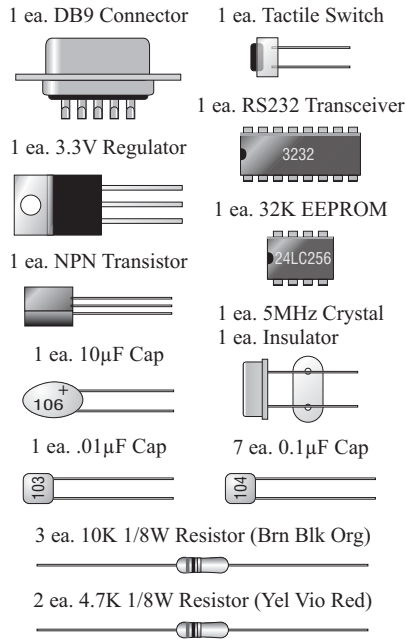

## Assembly & Testing

To assemble and test the PropSTICK, you will need a low-wattage soldering iron with a fine tip, some rosin-core solder, a good pair of lead trimmers (side-cutters), needle-nosed pliers, a +5VDC supply, and a voltmeter. First, familiarize yourself with the circuit board. The top (component) side is the side with the white silkscreen legend. The bottom (solder) side has the copyright notice. This is the side that gets soldered. Now, take the voltage regulator and, with the pliers, bend the leads as shown:

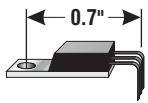

Then insert the leads through their respective holes. Jockey the IC around if necessary so the large holes in its metal tab and in the board line up. Make sure the package is flat against the board. You can use a #4 screw and a nut (not included) to hold the IC in place if you like. Solder the middle pin, and recheck the alignment. Then

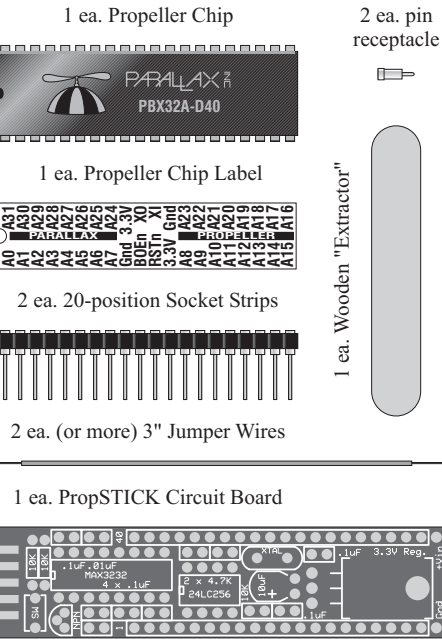

solder the other two pins.

Next, mount the two small DIPs, aligning their notches with the silkscreen. You may need to flex the leads inward to get all the pins through their holes. Push the ICs in all the way, flip the board over, and solder them in place. The board will look like this:

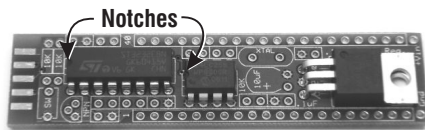

Next, bend the leads of the 10 $\mu$ F capacitor as shown:



Insert the cap's leads through the holes on the board, making sure the "+" signs align. Solder one lead and verify that the cap is lying flat, then solder the other lead.

Remove the Mylar crystal insulator from its backing, and slide it onto the crystal leads, sticky side facing away from the crystal. Insert the crystal leads through the holes in

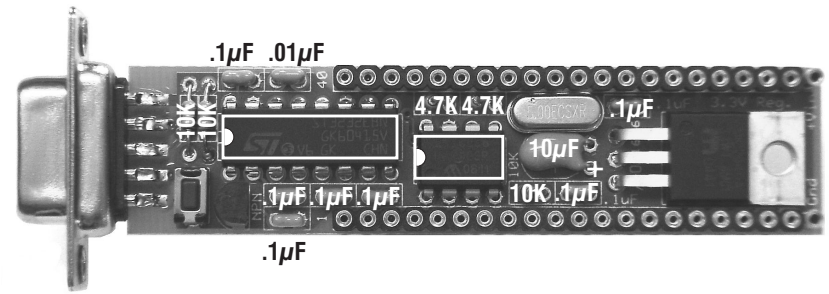

the board, and push it in all the way. The insulator will ride up the leads and adhere to the board. Solder the crystal into place.

Next, mount and solder everything else *except the DB9 connector, the sockets, the transistor, and the switch*. Use the photo above as a guide for those parts designators covered by the DIPs. The resistors that are mounted on 0.1" centers should be bent transistor-radio-style, as shown:

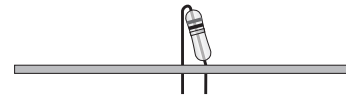

Keep the loops tight, but not kinked. As you go along, you should trim the soldered leads as close to the circuit board as you can. The board will look like this:

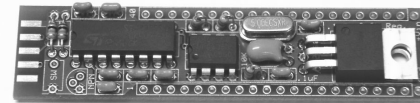

Now, take the two 20-pin socket strips and insert them through their holes. *Make sure the strips are wholly within the rectangular areas designated for them*. There should be one empty hole left over in each row at the end of the board. Flip the board over and place on a flat, smooth surface. See photo:

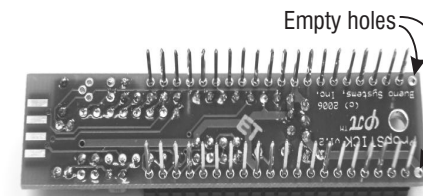

Solder one of the middle pins on each socket strip. *Try not to get solder too far up the leg*

*of the pin. A small fillet near the hole is all you want. Neatness counts here, so take your time!* Check to make sure the soldered pins are all the way in and that the sockets are sitting squarely atop the board. If not, press the board down with one hand while heating the solder joint with the other. Now, do the same with the pins on the ends, again making sure they're inserted all the way and that the sockets are squarely seated. Finally, solder the remaining pins, checking and correcting the seating as you go along.

Take the two pin receptacles, insert them squarely into their respective holes (the "leftover" socket holes, and solder them in place.

Now, grab the DB9 connector and slide it over the pads at the end of the board. There will be five pins on top and four on the bottom. Make sure the pins align with their respective pads, and solder the middle pin on top to its pad. Double check the alignment, and adjust if necessary. Then solder the other eight pins to their pads.

The last items to be installed are the transistor and switch. Push them in as far as they will go, and solder them into place. Make sure all the leads (excepting the socket strips, of course) are trimmed close to the board.

To test the board, you will need a +5VDC power supply. Push the PropSTICK into a solderless breadboard, as shown on the next page. Apply power to the +Vin and Gnd sockets at the end of the board. With a voltmeter, measure the voltage between pins 2 and 3 of the voltage regulator. It should read 3.3V. Also, verify the voltage between the Propeller's 3.3V and Gnd positions. You can lay the vinyl label (with the backing still on) between the socket strips as an aid in finding the right positions to check.