

REP430F

Replicator for MSP430 MCU

User's Manual

PM041A01 Rev.0
October-23-2009

Elprotronic Inc.

Elprotronic Inc.

16 Crossroads Drive
Richmond Hill,
Ontario, L4E-5C9
CANADA

Web site: www.elprotronic.com
E-mail: info@elprotronic.com
Fax: 905-780-2414
Voice: 905-780-5789

Copyright © Elprotronic Inc. All rights reserved.

EVALUATION BOARD/KIT IMPORTANT NOTICE

Elprotronic Inc. provides the enclosed product(s) under the following conditions:

This evaluation board/kit is intended for use for **ENGINEERING DEVELOPMENT, DEMONSTRATION, OR EVALUATION PURPOSES ONLY** and is not considered by Elprotronic Inc. to be a finished end-product fit for general consumer use. Persons handling the product(s) must have electronics training and observe good engineering practice standards. As such, the goods being provided are not intended to be complete in terms of required design-, marketing-, and/or manufacturing-related protective considerations, including product safety and environmental measures typically found in end products that incorporate such semiconductor components or circuit boards. This evaluation board/kit does not fall within the scope of the European Union directives regarding electromagnetic compatibility, restricted substances (RoHS), recycling (WEEE), FCC, CE or UL, and therefore may not meet the technical requirements of these directives or other related directives.

Should this evaluation board/kit not meet the specifications indicated in the User's Guide, the board/kit may be returned within 30 days from the date of delivery for a full refund. **THE FOREGOING WARRANTY IS THE EXCLUSIVE WARRANTY MADE BY SELLER TO BUYER AND IS IN LIEU OF ALL OTHER WARRANTIES, EXPRESSED, IMPLIED, OR STATUTORY, INCLUDING ANY WARRANTY OF MERCHANTABILITY OR FITNESS FOR ANY PARTICULAR PURPOSE.**

The user assumes all responsibility and liability for proper and safe handling of the goods. Further, the user indemnifies Elprotronic Inc. from all claims arising from the handling or use of the goods. Due to the open construction of the product, it is the user's responsibility to take any and all appropriate precautions with regard to electrostatic discharge.

EXCEPT TO THE EXTENT OF THE INDEMNITY SET FORTH ABOVE, NEITHER PARTY SHALL BE LIABLE TO THE OTHER FOR ANY INDIRECT, SPECIAL, INCIDENTAL, OR CONSEQUENTIAL DAMAGES.

Elprotronic Inc. assumes **no liability for applications assistance, customer product design, software performance, or infringement of patents or services described herein.**

Please read the User's Guide and, specifically, the Warnings and Restrictions notice in the User's Guide prior to handling the product. This notice contains important safety information about temperatures and voltages. For additional information on Elprotronic Inc. environmental and/or safety programs, please contact the Elprotronic Inc. application engineer. No license is granted under any patent right or other intellectual property right of Elprotronic Inc. covering or relating to any machine, process, or combination in which such Elprotronic Inc. products or services might be or are used.

FCC WARNING

This evaluation board/kit is intended for use for **ENGINEERING DEVELOPMENT, DEMONSTRATION, OR EVALUATION PURPOSES ONLY** and is not considered by Elprotronic Inc. to be a finished end-product fit for general consumer use. It generates, uses, and can radiate radio frequency energy and has not been tested for compliance with the limits of computing devices pursuant to part 15 of FCC rules, which are designed to provide reasonable protection against radio frequency interference. Operation of this equipment in other environments may cause interference with radio communications, in which case the user at his own expense will be required to take whatever measures may be required to correct this interference.

Table of Contents

1.	<i>Introduction</i>	5
2.	<i>Feature</i>	6
2.1	Specification	7
3.	Software	8
4.	<i>Hardware</i>	9
4.1	Powering REP430F	10
4.2	Host JTAG connector	11
4.3	Target JTAG/BSL connectors	11
4.4	Options switch	13
4.5	LEDs	13
4.6	Buttons	14
4.7	Schematic, PCB, BOM	14

1. Introduction

The **REP430F** replicator is dedicated to programming the Texas Instruments (TI) MSP430Fxx family of microcontrollers. It allows the programming of target devices via the JTAG Interface (4-wires), SBW (Spy-Bi-Wire) (2-wires) and via the BSL (Boot Strap Loader) Interface. The replicator is built on the newest MSP430F5437 MCU with 256 kB of flash memory.

The **REP430F** replicator operates in accordance with TI's **MSP430 Memory Programming User's Guide** Application Note **SLAU265**. The AN **SLAU265** documents the JTAG communication protocol that allows erasing, programming and verification of the MSP430 MCU via JTAG or Spy-Bi-Wire communication protocols. MSP430Fxx microcontrollers can be programmed via the JTAG or Spy-Bi-Wire Interface as long as the Security Fuse is not blown. When the Security Fuse is blown then the MSP430Fxx microcontrollers can still be accessed, but only via the BSL Interface. The complete C source code and project files are provided by Texas Instruments. See AN **SLAU265** and TI website for details.

The **REP430F** package contains:

- * one REP430F PCB/Evaluation Board,
- * one 14 wires ribbon cable,
- * CD with documentation and software.

2. Feature

Key features of the REP430F Replicator include:

- * an MSP430F5437 as a host MCU with 256 kB of flash for saving firmware and code.
- * support for all MSP430 flash-based devices. There are specific software projects for the following target device Replicator implementations:
 - * **Replicator:** For MSP430 architecture devices (includes both 4-wire JTAG and Spy-Bi-Wire implementation)
 - * **ReplicatorX:** For MSP430X extended architecture devices only (includes both 4-wire JTAG and Spy-Bi-Wire implementation)
 - * **ReplicatorXv2:** For MSP430Xv2 (5xx, 6xx Family) extended architecture devices only (includes both 4-wire JTAG and Spy-Bi-Wire implementation)
- * support for program code size of approximately 200kB.
- * Speed (Erase, Program, Verify): approximately 8 KB in 1.5 s, 48 KB in 8 s
- * Verify and erase check: 17 KB/10 ms
- * Support for JTAG, SBW and BSL interfaces. Capability to blow the JTAG/SBW security fuse.
- * Stand-alone target programming operation (no PC or additional supporting hardware/software required)
- * Programmable Vcc from 2.1V to 3.6V with step 0.1V.
- * Replicator can be supplied from an external power supply (8V to 10V / 300 mA) or from target device (2.5V-3.6V).

2.1 Specification

Host MCU Type	- MSP430F5437
XTAL frequency	- 12 MHz
MCU frequency	- up to 18MHz using internal PLL in theMSP430F5437
REP430F Supply	
With Fuse Blown capability for MSP430F1xx, F2xx and F4xx	
- External	- 8 to 10V/ 300mA
With Fuse Blown capability for MSP430F5xx, F6xx	
- External	- 4 to 10V/ 300mA
- From Target device	- 2.5 to 4V
Without Fuse Blown capability	
- External	- 4 to 10V/ 300mA
- From Target device	- 2.5 to 4V
Current consumption	- 30mA max plus Target device's current supply
Target device power supply from REP430F	- programmable from 2.1V to 3.6V with step 0.1V / up to 200mA
Vpp voltage for blow the Security Fuse	- 6.5V +/- 0.3V
HOST connector to programming adapter	- 14 pins header - JTAG - TI standard for MSP430
Target connector	- 14 pins header - JTAG/SBW and BSL (TI standard plus added BSL) - 10 pins header - BSL only (TI standard)
PCB size	- 3 " x 2 " (76.2 mm x 51.2 mm)

3. *Software*

The **REP430F** replicator software has to be written by the user and usually contains the firmware that allows to download the code to the target device and the code to be downloaded as well. If required, some testing procedures can be combined with the code downloaded to **REP430F**.

Texas Instruments prepared a library of firmware that allows code to be downloaded to target devices using the **REP430F**. Users can take advantage of TI's library, add their own code that should be downloaded to target device and recompile combined project. Final code downloaded to REP430F allows to download the flash contents to desired target device. Detailed information is provided in TI's **MSP430 Memory Programming User's Guide** Application Note **SLAU265**. See chapter 9 for details. The latest User's Guide and software package can be downloaded from TI's website

<http://focus.ti.com/docs/toolsw/folders/print/rep430f.html>

The same software can be downloaded also from Elprotronic's website

<http://www.elprotronic.com/rep430f.html>

or taken from the CD attached to the REP430F package. When software is installed from CD or from the file taken from the Elprotronic's website, then it is located in directory

C:\Program Files\Elprotronic\MSP430\REP430F Replicator\TI-SLAU265-Files

in the file JTAG Programming.zip. Unzip this file to get the project files created for CCS4 and IAR IDE software

4. Hardware

The Figure 4.1 shows the major parts of the **REP430F** replicator. Detailed schematic and PCB layout are presented on Figures 4-3, 4-4, 4-5, 4-6, 4-7 and 4-8. BOM is presented in the table on page 19.

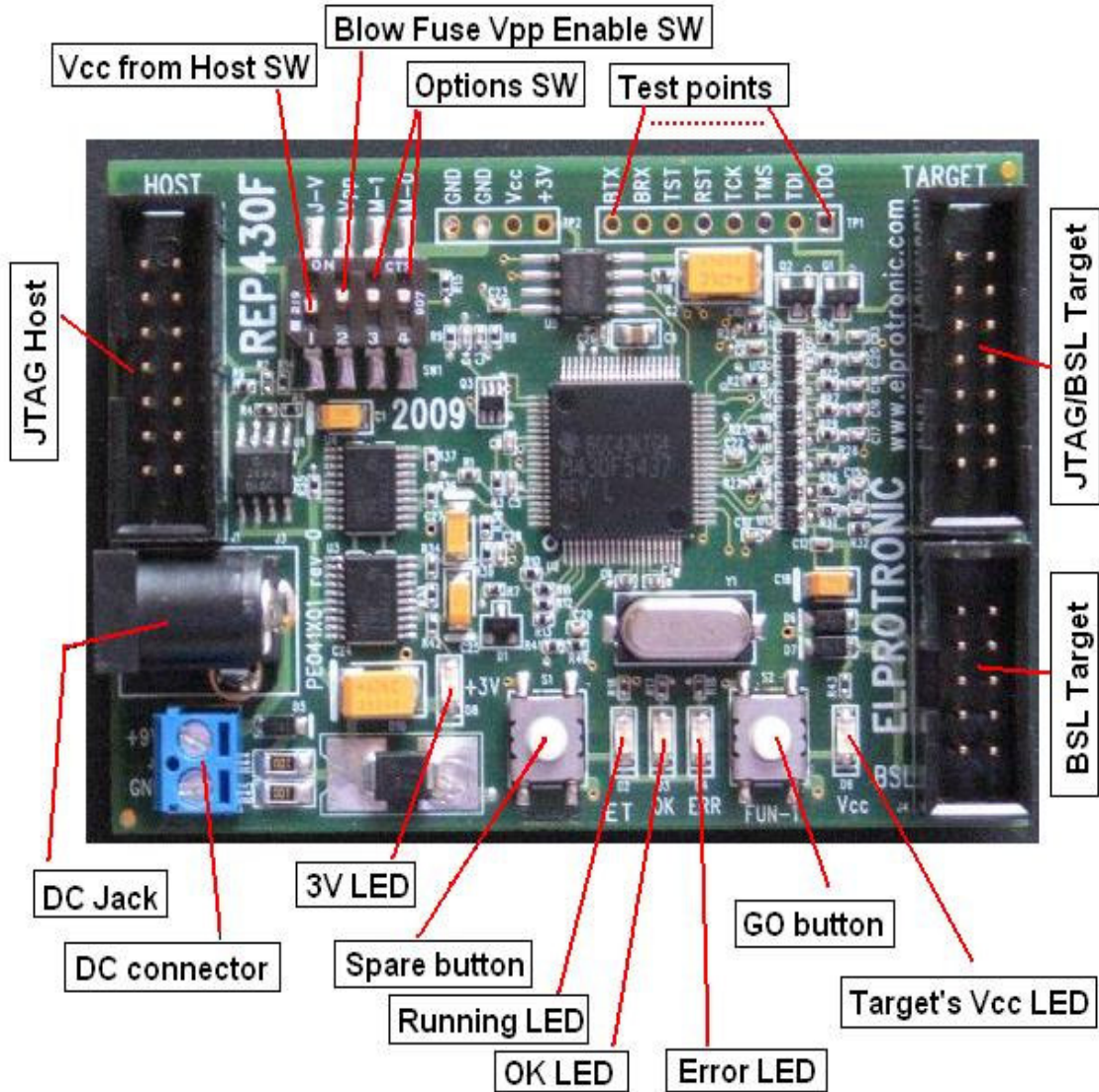

Figure 4.1

4.1 Powering REP430F

The **REP430F** replicator can be powered in several ways:

- * DC jack connector with standard DC jack power connectors with a 1.95mm center pin and external connector diameter 6.0 mm . The center pin is used for the positive voltage. A 4-10V DC power supply should be used. The onboard voltage regulators supplies Vcc 3.0V to the board and Vpp 6.5V to blow the security fuse circuit.
- * Terminal block power supply. Ground should be connected to the GND terminal on the power connector (see Figure 4.1). A 4-10V supply can be connected to the “9V” terminal.
- * Power supply from target device connector - pin 4. Ground should be connected to pin 9 and a 4-10V supply can be connected to pin-4 of the Target’s connector.
- * Power supply from target device connector - pin 2. Ground should be connected to pin 9 and the Vcc taken directly from the target’s MCU Vcc (2.5V to 3.6V) can be connected to pin-2 of the Target’s connector.
- * Power supply from the Host JTAG connector. Ground should be connected to pin 9 and the Vcc (2.5 to 3.6V) taken directly from the Host JTAG adapter connected to pin-2 of the Target’s connector. Switch “*Vcc from Host SW*” should be on “*ON*” position (see figure 4.1)

If several power sources are connected to REP430F replicator the board will be powered from the supply that supplies the highest voltage.

The board should be supplied from external power supply 8 to 10V (min 200mA) if blowing the physical security fuse in the target devices MSP320F1xx, F2xx or F4xx feature is used. If the **REP430F** board is used with targets F5xx, F6xx (with or without blowing the security fuse option) or with targets F1xx, F2xx, F4xx without blowing the security fuse option, then the board can be supplied from external power supply as low as 4V. If board is supplied with a voltage lower than 4V, then the functionality is still available, however setting the Vcc target device can be limited to lower voltage only.

4.2 Host JTAG connector

The Host JTAG connector (J1) is connected directly to JTAG pins of the MSP430F5437 MCU and allows to download a code to REP430F MCU and debug it. For debugging should be used standard FET debugging adapter and software eg. TI's MST-FET430UIF adapter and Code Composer Essential, IAR or other debugging IDE software.

4.3 Target JTAG/BSL connectors

The pinout of the JTAG connector (J2) with added BSL-Tx and BSL-Rx signals is shown in figure 4-2. BSL-Tx and BSL-Rx signals are connected to the pins 12 and 14 respectively. Detailed description of the J2 and J4 are presented in Table 1 and 2.

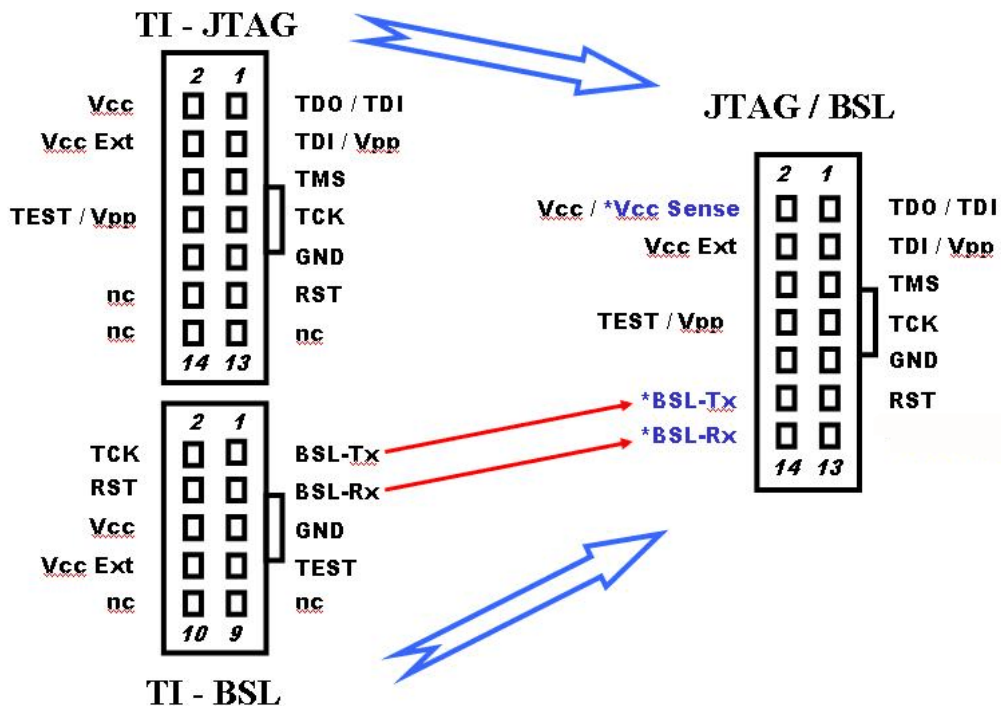

Figure 4-2

Table 1 JTAG/BSL Interface connector (J2)

Pin #	Name	Description
1 (Red)	TDO/TDI	JTAG Data Output/Input (From/To target device)
2	Vcc/ Sense	Vcc supplied Target Device and Target's Device Vcc Sense
3	TDI-Vpp	JTAG Data Input (to target device) - Blow Fuse voltage Vpp (+6.5V)
4	Ext-Vcc	External Vcc
5	TMS	TMS (to target device)
6	NC	Not connected
7	TCK	JTAG TCK (to target device)
8	TEST-Vpp	JTAG TEST (to target device), Blow Fuse voltage Vpp (+6.5V)
9	GND	Ground
10	NC	Not connected
11	VRST	Reset (Active LOW) (to target device).
12	BTX	Bootloader Tx Output (from target device)
13	NC	Not connected

Table 2 BSL Interface connector (J4)

Pin #	Name	Description
1 (Red)	BTX	Bootloader Tx Output (from target device)
2	TCK	Bootloader TCK (to target device)
3	BRX	Bootloader Rx Input (to target device)
4	VRST	Reset (Active LOW) (to target device).
5	GND	Ground
6	VCC/ Sense	Vcc supplied Target Device and Target's Device Vcc Sense
7	TEST	Bootloader / JTAG TEST Input pin (note-4)
8	Ext-Vcc	External Vcc
9	nc	Not connected
10	nc	Not connected

4.4 Options switch

Option switch contains the following four switches to modify the replicator's configuration:

- * J-V - supply enable the replicator from host programming adapter
- * Vpp - Vpp (6.5V) for blow the security fuse enable
- * M-1 - mode - 1
- * M-0 - mode - 0

Switch J-V allows to connect the Vcc from the host programming adapter directly to the MSP430F5437 MCU and supply it. When this option is used, then no external power supply is required for the REP430F. Current provided from programming adapter should be higher than 30mA. This option is useful for debugging.

Switch Vpp is used for blowing the JTAG security fuse. If this switch is in the “**ON**” position then the Vpp 6.5V can be used to blow the security fuse. If the Vpp switch is in the “**OFF**” position then the Vpp 6.5 V is off and the physical fuse in the MSP430F1xx, F2xx and F4xx cannot be blown regardless of other software options. However, the fuse can be blown if the MSP430F5xx or F6xx microcontrollers are used. Position of the Vpp switch can be detected by the software.

Switches M-0 and M-1 are connected directly to MCU and can be used for mode detection - Mode0, (00), Mode-1 (01), Mode-2 (10) and Mode-3 (11). Type of modes are related to software as an extra options.

4.5 LEDs

The **REP430F** contains five LEDs.

- * 3V - Yellow LED - is connected directly to internal 3V and indicate the presence of the REP430 power supply
- * Vcc - Green LED - is connected directly to target's Vcc and indicate presence of the power supply on target device. The LEDs intensity can vary vs value of the Vcc (2.1 to 3.6V) on the target device.
- * RUN - Yellow LED - controlled by software - indicates in progress status (running)

- * OK - Green LED - controlled by software - indicates that process has been finished successfully
- * ERR - Red LED - controlled by software - indicates error at the end.

4.6 Buttons

The **REP430F** contains two buttons:

- GO (FUN-1) - this button is connected directly to RESET/NMI pin of the MSP430F5437 MCU and is used to reset and start the application (eg. erasing, programming and verification process in the target device)
- Spare - this button is connected directly to I/O of the MSP430F5437 and can be used for any other application used in software eg. for target device verification only.

4.7 Schematic, PCB, BOM

The REP430F schematic, PCB layout and BOM are presented below.

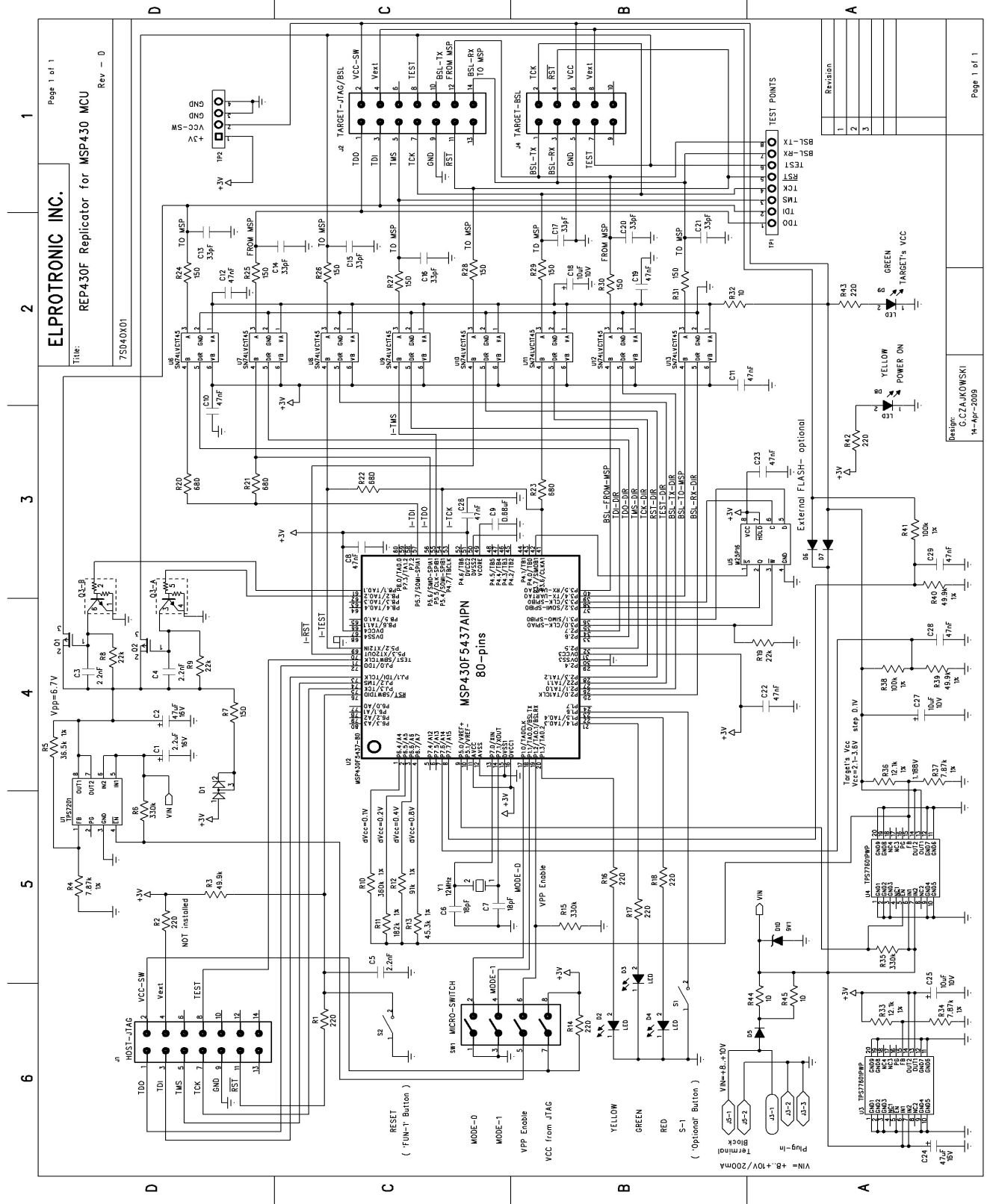

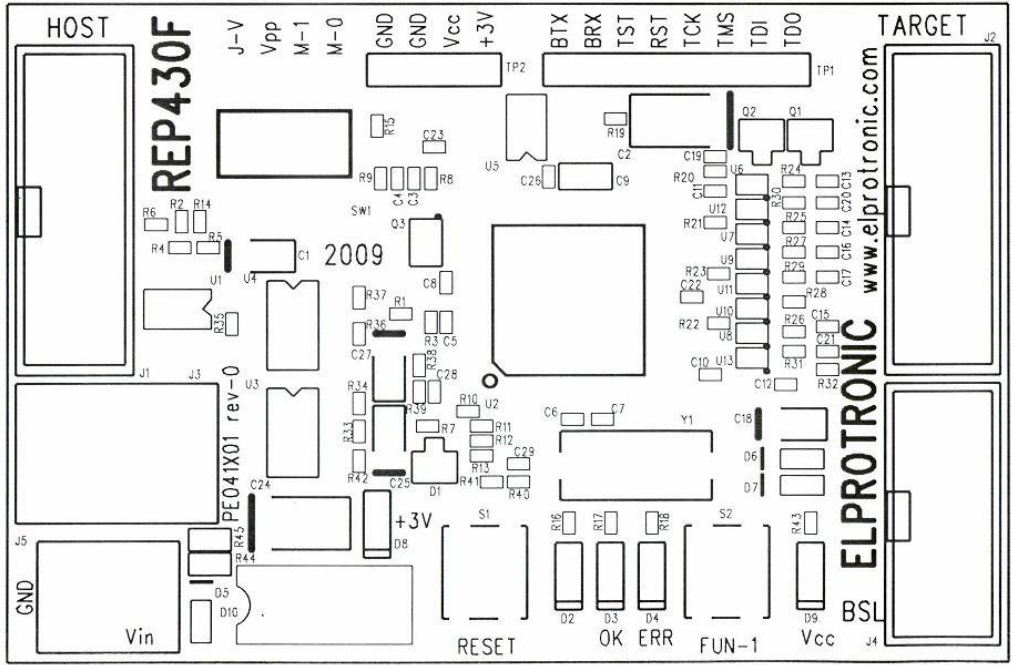

Figure 4.4 - Silkscreen

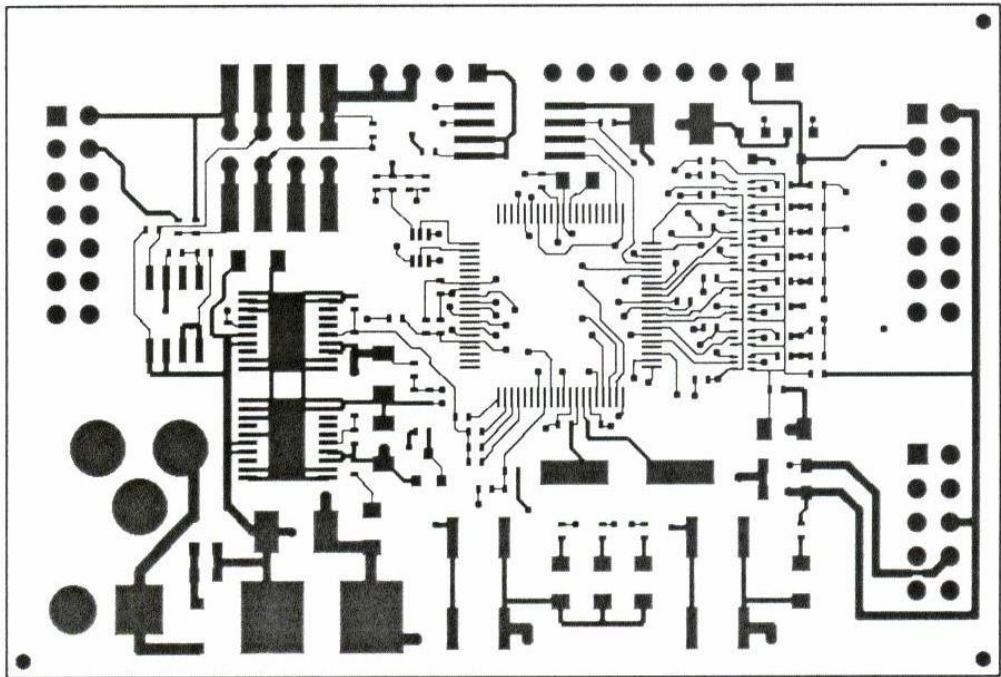

Figure 4.5 - PCB - Top

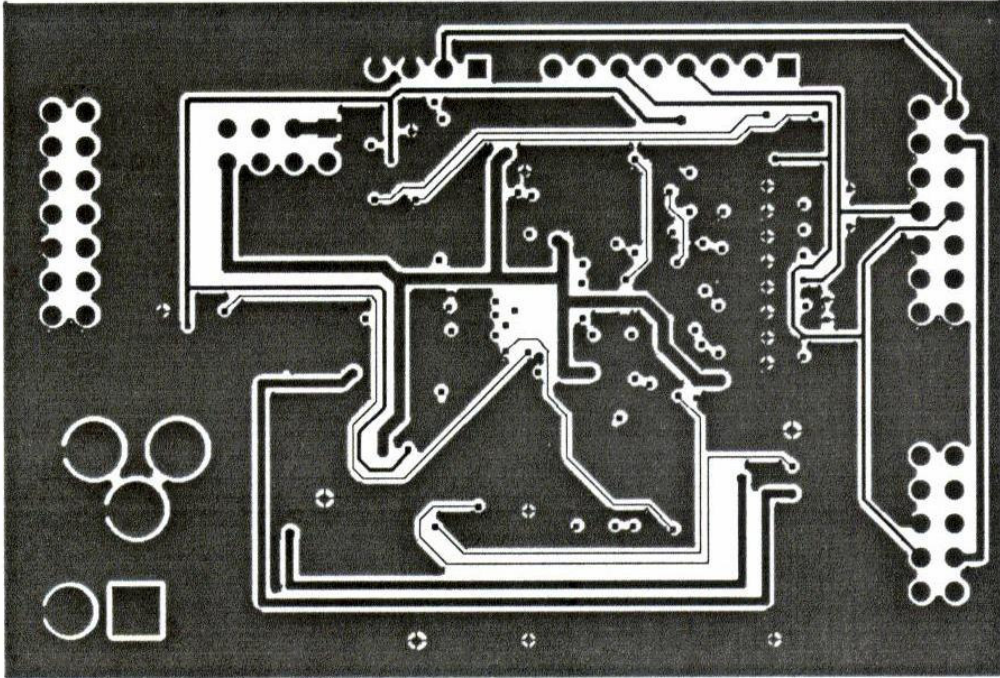

Figure 4.6: PCB - Layer-2

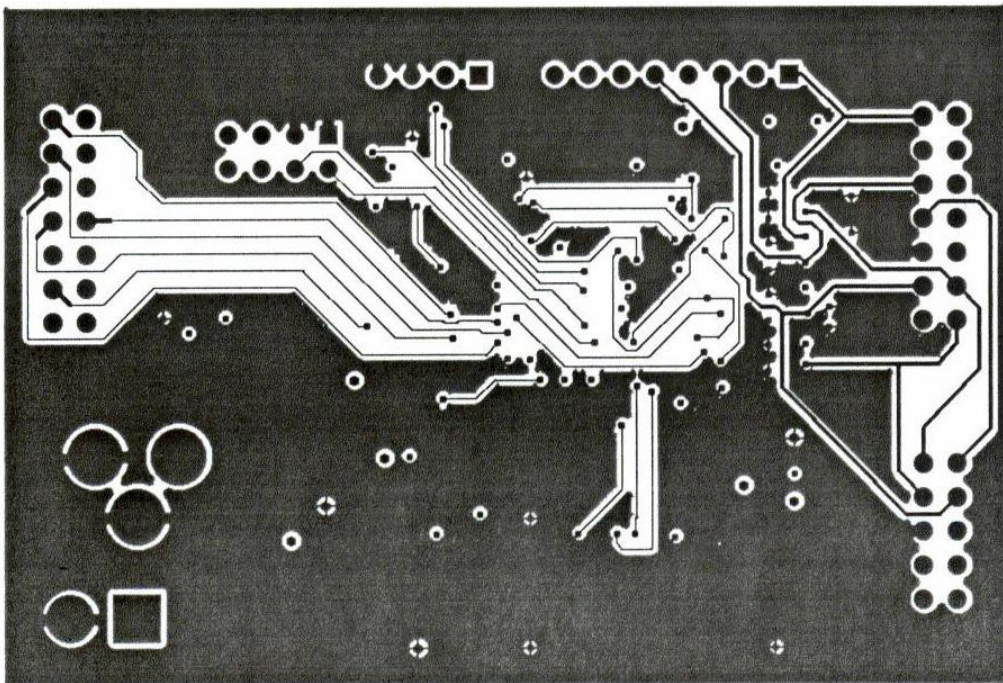

Figure 4-7: PCB - Layer - 3

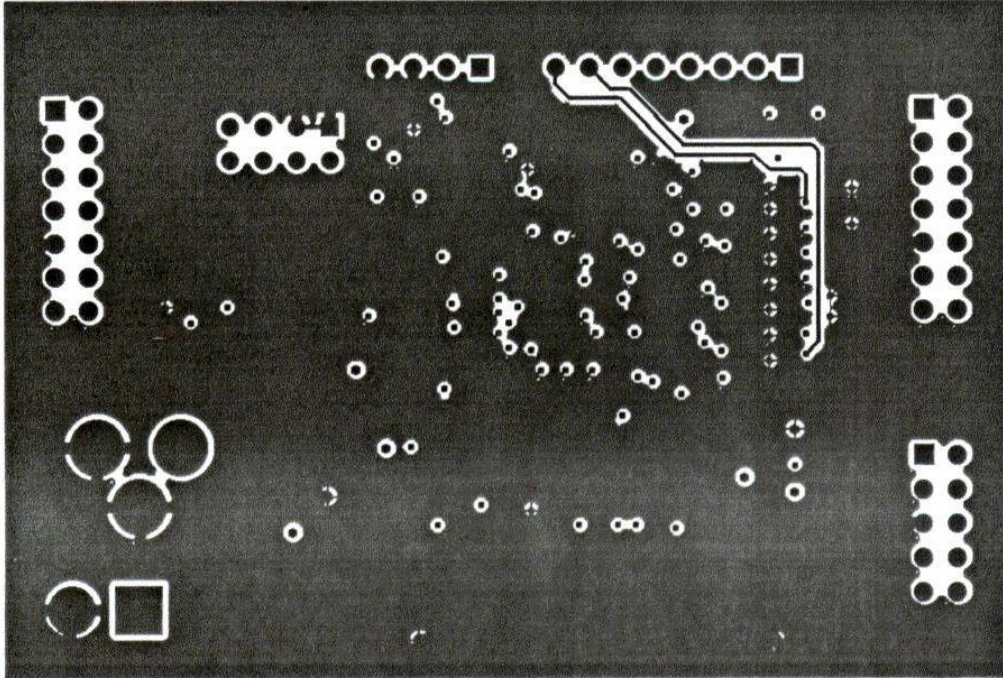

Figure 4-8: PCB - Bottom

		MSP430 Replicator REP430F BOARD ASSEMBLY		DRAWING NUMBER
				PE041X01-rev-0
ITEM	NAME	DRWG & PART NO	- 01	DESCRIPTION
1	BLANK PC BOARD	PE041X01 rev-0	1	Blank PC Board
	THRU HOLE COMPONENTS			
J1	Connector	279 35-514-0	1	14-pins Header Streight Connector (Electrosonic)
J2	Connector	279 35-514-0	1	14-pins Header Streight Connector (Electrosonic)
J3	Connector	NEB 21 R / 97K6458	1	Power Supply Connector - 12V/3A, Dia - 6 / 1.95 mm (Lumberg / Newark)
J4	Connector	279 35-510-0	1	10-pins Header Streight Connector (Electrosonic)
J5	Connector	OSTTE030161 / ED2635-ND	1	2 pins terminal block/Tyco / DigiKey
TP1	TEST POINTS			
TP2	TEST POINTS			
	SMD COMPONENTS			
C1	Tantalum Capacitor	TAJA225K016R	1	Cap Tan Chip 2.2uF 16V 10% Size-A (AVX or eq.)
C2	Tantalum Capacitor	TAJC476K016R	1	Cap Tan Chip 47uF 16V 10% Size-C (AVX or eq.)
C3	Capacitor	04025C222KAT2A	1	Cap Cer Chip 2.2nF X7R 10% 50V 0402 (AVP or eq.)
C4	Capacitor	04025C222KAT2A	1	Cap Cer Chip 2.2nF X7R 10% 50V 0402 (AVP or eq.)
C5	Capacitor	04025C222KAT2A	1	Cap Cer Chip 2.2nF X7R 10% 50V 0402 (AVP or eq.)
C6	Capacitor	GRM155C1H180JZ	1	Cap Cer Chip 18pF NPO 5% 50V 0402 (AVX or eq.)
C7	Capacitor	GRM155C1H180JZ	1	Cap Cer Chip 18pF NPO 5% 50V 0402 (AVX or eq.)
C8	Capacitor	CL05B473K05	1	Cap Cer Chip 47nF X7R 10% 16V 0402 (AVX or eq.)
C9	Capacitor	0805YC684KAT2A	1	Cap Cer Chip 0.68uF X7R 10% 16V 0805 (AVX or eq.)
C10	Capacitor	CL05B473K05	1	Cap Cer Chip 47nF X7R 10% 16V 0402 (AVX or eq.)
C11	Capacitor	CL05B473K05	1	Cap Cer Chip 47nF X7R 10% 16V 0402 (AVX or eq.)
C12	Capacitor	CL05B473K05	1	Cap Cer Chip 47nF X7R 10% 16V 0402 (AVX or eq.)
C13	Capacitor	MCH155A330JK	1	Cap Cer Chip 33pF NPO 5% 50V 0402 (AVX or eq.)
C14	Capacitor	MCH155A330JK	1	Cap Cer Chip 33pF NPO 5% 50V 0402 (AVX or eq.)
C15	Capacitor	MCH155A330JK	1	Cap Cer Chip 33pF NPO 5% 50V 0402 (AVX or eq.)
C16	Capacitor	MCH155A330JK	1	Cap Cer Chip 33pF NPO 5% 50V 0402 (AVX or eq.)
C17	Capacitor	MCH155A330JK	1	Cap Cer Chip 33pF NPO 5% 50V 0402 (AVX or eq.)
C18	Tantalum Capacitor	TAJA106K010R	1	Cap Tan Chip 10uF 10V 10% Size-A (AVX or eq.)
C19	Capacitor	CL05B473K05	1	Cap Cer Chip 47nF X7R 10% 16V 0402 (AVX or eq.)
C20	Capacitor	MCH155A330JK	1	Cap Cer Chip 33pF NPO 5% 50V 0402 (AVX or eq.)
C21	Capacitor	MCH155A330JK	1	Cap Cer Chip 33pF NPO 5% 50V 0402 (AVX or eq.)
C22	Capacitor	CL05B473K05	1	Cap Cer Chip 47nF X7R 10% 16V 0402 (AVX or eq.)
C23	Capacitor	CL05B473K05	1	Cap Cer Chip 47nF X7R 10% 16V 0402 (AVX or eq.)
C24	Tantalum Capacitor	TAJC476K016R	1	Cap Tan Chip 47uF 16V 10% Size-C (AVX or eq.)
C25	Tantalum Capacitor	TAJA106K010R	1	Cap Tan Chip 10uF 10V 10% Size-A (AVX or eq.)
C26	Capacitor	CL05B473K05	1	Cap Cer Chip 47nF X7R 10% 16V 0402 (AVX or eq.)

C27	Tantalum Capacitor	TAJA106K010R	1	Cap Tan Chip 10uF 10V 10% Size-A (AVX or eq.)
C28	Capacitor	CL05B473K05	1	Cap Cer Chip 47nF X7R 10% 16V 0402 (AVX or eq.)
C29	Capacitor	CL05B473K05	1	Cap Cer Chip 47nF X7R 10% 16V 0402 (AVX or eq.)
D1	Diode	BAT54S-NL	1	DUAL-SERIES Schottky Siodes - SOT-23 -Pb-Free (OnSemi)
D2	Diode - LED (yellow)	SML-LX1206YC / 671358-1-ND	1	SM LEDs 1206, Yellow (Lumex / DigiKey)
D3	Diode - LED (green)	SML-LX1206GC / 671357-1-ND	1	SM LEDs 1206, Green (Lumex / DigiKey)
D4	Diode - LED (red)	SML-LX1206IC / 671356-1-ND	1	SM LEDs 1206, Red (Lumex / DigiKey)
D5	Diode	MBR0520LT1G	1	Schottky Diode 0.5A/20V SOD-123 Pb-Free (OnSemi)
D6	Diode	MBR0520LT1G	1	Schottky Diode 0.5A/20V SOD-123 Pb-Free (OnSemi)
D7	Diode	MBR0520LT1G	1	Schottky Diode 0.5A/20V SOD-123 Pb-Free (OnSemi)
D8	Diode - LED (yellow)	SML-LX1206YC / 671358-1-ND	1	SM LEDs 1206, Yellow (Lumex / DigiKey)
D9	Diode - LED (green)	SML-LX1206GC / 671357-1-ND	1	SM LEDs 1206, Green (Lumex / DigiKey)
D10	Diode - Suppressor	1SMC9.0AT3	1	Voltage Suppressor, 9V SMC (On Semi)
Q1	Transistor	NTR0202PLT1G	1	P-MOSFET Transistor 20V/0.2A SOT-23
Q2	Transistor	NTR0202PLT1G	1	P-MOSFET Transistor 20V/0.2A SOT-23
Q3	Dual Transistor	MUN5213DW1T1G	1	Dual NPN Transistors with Bias Res. SOT-363 (OnSemi)
R1	Resistor	MCR01 MZP J 221	1	SMD Chip Res 220 Ohm 5% 1/16W 0402
R2	Resistor		---	
R3	Resistor	MCR01 MZP F 4992	1	SMD Chip Res 49.9kOhm 1% 1/16W 0402
R4	Resistor	MCR01 MZP F 7871	1	SMD Chip Res 7.87kOhm 1% 1/16W 0402
R5	Resistor	MCR01 MZP F 3652	1	SMD Chip Res 36.5kOhm 1% 1/16W 0402
R6	Resistor	MCR01 MZP J 334	1	SMD Chip Res 330 k Ohm 5% 1/16W 0402
R7	Resistor	MCR01 MZP J 151	1	SMD Chip Res 150 Ohm 5% 1/16W 0402
R8	Resistor	MCR01 MZP J 223	1	SMD Chip Res 22kOhm 5% 1/16W 0402
R9	Resistor	MCR01 MZP J 223	1	SMD Chip Res 22kOhm 5% 1/16W 0402
R10	Resistor	MCR01 MZP F 3603	1	SMD Chip Res 360 kOhm 1% 1/16W 0402
R11	Resistor	MCR01 MZP F 1823	1	SMD Chip Res 182 kOhm 1% 1/16W 0402
R12	Resistor	MCR01 MZP F 9102	1	SMD Chip Res 91.0kOhm 1% 1/16W 0402
R13	Resistor	MCR01 MZP F 4532	1	SMD Chip Res 45.3 k Ohm 1% 1/16W 0402
R14	Resistor	MCR01 MZP J 221	1	SMD Chip Res 220 Ohm 5% 1/16W 0402
R15	Resistor	MCR01 MZP J 334	1	SMD Chip Res 330 k Ohm 5% 1/16W 0402
R16	Resistor	MCR01 MZP J 221	1	SMD Chip Res 220 Ohm 5% 1/16W 0402
R17	Resistor	MCR01 MZP J 221	1	SMD Chip Res 220 Ohm 5% 1/16W 0402
R18	Resistor	MCR01 MZP J 221	1	SMD Chip Res 220 Ohm 5% 1/16W 0402
R19	Resistor	MCR01 MZP J 223	1	SMD Chip Res 22kOhm 5% 1/16W 0402
R20	Resistor	MCR01 MZP J 681	1	SMD Chip Res 680 Ohm 5% 1/16W 0402
R21	Resistor	MCR01 MZP J 681	1	SMD Chip Res 680 Ohm 5% 1/16W 0402
R22	Resistor	MCR01 MZP J 681	1	SMD Chip Res 680 Ohm 5% 1/16W 0402
R23	Resistor	MCR01 MZP J 681	1	SMD Chip Res 680 Ohm 5% 1/16W 0402
R24	Resistor	MCR01 MZP J 151	1	SMD Chip Res 150 Ohm 5% 1/16W 0402
R25	Resistor	MCR01 MZP J 151	1	SMD Chip Res 150 Ohm 5% 1/16W 0402
R26	Resistor	MCR01 MZP J 151	1	SMD Chip Res 150 Ohm 5% 1/16W 0402
R27	Resistor	MCR01 MZP J 151	1	SMD Chip Res 150 Ohm 5% 1/16W 0402
R28	Resistor	MCR01 MZP J 151	1	SMD Chip Res 150 Ohm 5% 1/16W 0402
R29	Resistor	MCR01 MZP J 151	1	SMD Chip Res 150 Ohm 5% 1/16W 0402
R30	Resistor	MCR01 MZP J 151	1	SMD Chip Res 150 Ohm 5% 1/16W 0402
R31	Resistor	MCR01 MZP J 151	1	SMD Chip Res 150 Ohm 5% 1/16W 0402
R32	Resistor	MCR01 MZP J 100	1	SMD Chip Res10 Ohm 5% 1/16W 0402

R33	Resistor	MCR01 MZP F 1212	1	SMD Chip Res 12.1kOhm 1% 1/16W 0402
R34	Resistor	MCR01 MZP F 7871	1	SMD Chip Res 7.87kOhm 1% 1/16W 0402
R35	Resistor	MCR01 MZP J 334	1	SMD Chip Res 330 k Ohm 5% 1/16W 0402
R36	Resistor	MCR01 MZP F 1212	1	SMD Chip Res 12.1kOhm 1% 1/16W 0402
R37	Resistor	MCR01 MZP F 7871	1	SMD Chip Res 7.87kOhm 1% 1/16W 0402
R38	Resistor	MCR01 MZP F 1003	1	SMD Chip Res 100kOhm 1% 1/16W 0402
R39	Resistor	MCR01 MZP F 4992	1	SMD Chip Res 49.9kOhm 1% 1/16W 0402
R40	Resistor	MCR01 MZP F 4992	1	SMD Chip Res 49.9kOhm 1% 1/16W 0402
R41	Resistor	MCR01 MZP F 1003	1	SMD Chip Res 100kOhm 1% 1/16W 0402
R42	Resistor	MCR01 MZP J 221	1	SMD Chip Res 220 Ohm 5% 1/16W 0402
R43	Resistor	MCR01 MZP J 221	1	SMD Chip Res 220 Ohm 5% 1/16W 0402
R44	Resistor	MCR18 EZPJ 100	1	SMD Chip Res 10 Ohm 5% 1/4W 1206
R45	Resistor	MCR18 EZPJ 100	1	SMD Chip Res 10 Ohm 5% 1/4W 1206
S1	Switch	EVQQT03W / P13616SDKR-ND	1	SMD Switch - NO, 6.0x6.5x3.1.5mm, 260GF (Panasonic / DigiKey)
S2	Switch	EVQQT03W / P13616SDKR-ND	1	SMD Switch - NO, 6.0x6.5x3.1.5mm, 260GF (Panasonic / DigiKey)
SW1	DIP switch	219-4MST / CT2194MST-ND	1	4 * SPST Switch (CTS / DigiKey)
U1	Integrated Circuit	TPS7201QD	1	LDO - Adjustable - SO-8 (Texas Instruments)
U2	Integrated Circuit	MSP430F5437IPN	1	Microcontroller - TQFP-80 (Texas Instruments)
U3	Integrated Circuit	TPS77601PWP	1	LDO - Adjustable - TSSOP-20 (Texas Instruments)
U4	Integrated Circuit	TPS77601PWP	1	LDO - Adjustable - TSSOP-20 (Texas Instruments)
U5	Integrated Circuit	M25P16-VMN6P	---	Flash - 2Mbytes SO8 (STM)
U6	Integrated Circuit	SN74LVC1T45DRLR	1	Single Bus Transceiver, SOT-533(DRL) (Texas Instr.)
U7	Integrated Circuit	SN74LVC1T45DRLR	1	Single Bus Transceiver, SOT-533(DRL) (Texas Instr.)
U8	Integrated Circuit	SN74LVC1T45DRLR	1	Single Bus Transceiver, SOT-533(DRL) (Texas Instr.)
U9	Integrated Circuit	SN74LVC1T45DRLR	1	Single Bus Transceiver, SOT-533(DRL) (Texas Instr.)
U10	Integrated Circuit	SN74LVC1T45DRLR	1	Single Bus Transceiver, SOT-533(DRL) (Texas Instr.)
U11	Integrated Circuit	SN74LVC1T45DRLR	1	Single Bus Transceiver, SOT-533(DRL) (Texas Instr.)
U12	Integrated Circuit	SN74LVC1T45DRLR	1	Single Bus Transceiver, SOT-533(DRL) (Texas Instr.)
U13	Integrated Circuit	SN74LVC1T45DRLR	1	Single Bus Transceiver, SOT-533(DRL) (Texas Instr.)
Y1	Crystal	ABLS-12.000MHz-B2-T	1	CRYSTAL 12MHz - HC49 Lead Free (ABRACON)