



NPN SILICON HIGH FREQUENCY TRANSISTOR

NE663M04

FEATURES

- **HIGH GAIN BANDWIDTH:** $f_T = 15$ GHz
- **HIGH POWER GAIN:** $IS_{21EI}^2 = 11$ dB TYP at 2 GHz
- **LOW NOISE FIGURE:** $NF = 1.2$ dB at 2 GHz
- **HIGH IP3:** $NF = 27$ dBm at 2 GHz
- **HIGH MAXIMUM STABLE GAIN:** 15 dB @ 2 GHz
- **LOW PROFILE M04 PACKAGE:**
SOT-343 footprint, with a height of just 0.59 mm.
Flat Lead Style for better RF performance.

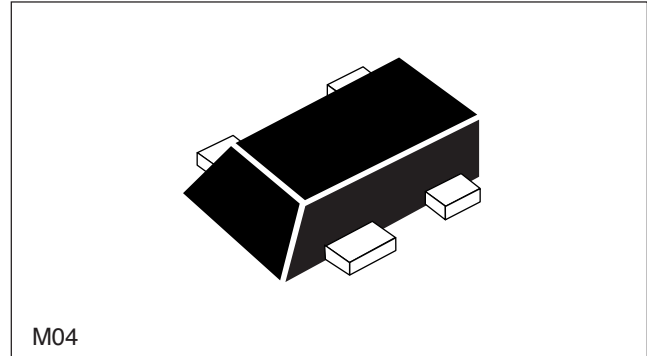

DESCRIPTION

NEC's NE663M04 is fabricated using NEC's UHS0 25 GHz f_T wafer process. With a typical transition frequency of 19 GHz the NE663M04 is usable in applications from 100 MHz to 5 GHz. The NE663M04 provides excellent low voltage/low current performance.

NEC's low profile/flat lead style "M04" package is ideal for today's portable wireless applications. The NE663M04 is an ideal choice for LNA and oscillator requirements in all mobile communication systems.

ELECTRICAL CHARACTERISTICS (T_A = 25°C)

PART NUMBER EIAJ ¹ REGISTERED NUMBER PACKAGE OUTLINE		NE663M04 2SC5509 M04				
SYMBOLS	PARAMETERS AND CONDITIONS	UNITS	MIN	TYP	MAX	
DC	I _{CBO}	Collector Cutoff Current at V _{CE} = 5 V, I _E = 0	μA		0.6	
	I _{EBO}	Emitter Cutoff Current at V _{EB} = 1 V, I _C = 0	μA		0.6	
	h _{FE}	Forward Current Gain ² at V _{CE} = 2 V, I _C = 10 mA		50	70	100
RF	f _T	Gain Bandwidth at V _{CE} = 3 V, I _C = 90 mA, f = 2 GHz	GHz	13	15	
	IS _{21EI} ²	Insertion Power Gain at V _{CE} = 2 V, I _C = 50 mA, f = 2 GHz	dB	8	11	
	MSG	Maximum Stable Gain ⁴ at V _{CE} = 2 V, I _C = 50 mA, f = 2 GHz	dB		15	
	P1dB	Output Power at 1 dB compression point at V _{CE} = 2 V, I _C = 70 mA ⁵ , f = 2 GHz	dBm		17	
	IP ₃	Third Order Intercept Point at V _{CE} = 2 V, I _C = 70 mA, f = 2 GHz	dBm		27	
	NF	Noise Figure at V _{CE} = 2 V, I _C = 10 mA, f = 2 GHz, Z _{IN} = Z _{OPT}	dB		1.2	1.7
Cre	Feedback Capacitance ³ at V _{CB} = 2 V, I _C = 0, f = 1 MHz	pF		0.5	0.75	

Notes:

1. Electronic Industrial Association of Japan.
2. Pulsed measurement, pulse width ≤ 350 μs, duty cycle ≤ 2 %.
3. Capacitance is measured by capacitance meter (automatic balance bridge method) when emitter pin is connected to the guard pin.
4. $MSG = \left| \frac{S_{21}}{S_{12}} \right|$
5. Collector current at P1dB compression.

ABSOLUTE MAXIMUM RATINGS¹ (T_A = 25°C)

SYMBOLS	PARAMETERS	UNITS	RATINGS
V _{CB0}	Collector to Base Voltage	V	15
V _{CE0}	Collector to Emitter Voltage	V	3.3
V _{EB0}	Emitter to Base Voltage	V	1.5
I _C	Collector Current	mA	100
P _T	Total Power Dissipation	mW	190
T _J	Junction Temperature	°C	150
T _{STG}	Storage Temperature	°C	-65 to +150

Note:

1. Operation in excess of any one of these parameters may result in permanent damage.

OUTLINE DIMENSIONS (Units in mm)

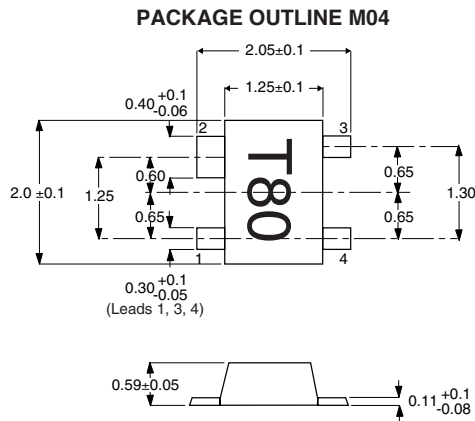

PIN CONNECTIONS

1. Emitter
2. Collector
3. Emitter
4. Base

ORDERING INFORMATION

PART NUMBER	QUANTITY	PACKAGING
NE663M04-T2-A	3000	Tape & Reel

TYPICAL NOISE PARAMETERS (T_A = 25°C)

FREQ. (GHz)	NF _{MIN} (dB)	G _A (dB)	Γ _{OPT}		R _n /50
			MAG	ANG	
V _C = 2 V, I _C = 5 mA					
0.90	0.81	17.51	0.23	161.68	0.10
1.00	0.84	16.66	0.25	151.89	0.10
1.20	0.89	15.33	0.27	132.37	0.09
1.50	0.98	13.71	0.31	103.26	0.08
1.70	1.03	12.79	0.34	83.97	0.08
1.90	1.09	11.96	0.36	64.78	0.07
2.00	1.12	11.58	0.38	55.22	0.07
2.20	1.18	10.88	0.40	36.16	0.07
2.50	1.28	9.95	0.43	7.75	0.07
3.00	1.44	8.69	0.49	-39.14	0.08
3.50	1.61	7.69	0.54	-85.46	0.12
4.00	1.79	6.88	0.58	-131.19	0.21
4.50	1.98	6.22	0.63	-176.35	0.38
V _C = 2 V, I _C = 10 mA					
0.90	0.94	19.02	0.16	221.12	0.09
1.00	0.95	18.12	0.18	193.71	0.09
1.20	0.99	16.72	0.21	142.02	0.08
1.50	1.05	15.02	0.25	72.33	0.08
1.70	1.09	14.04	0.28	31.09	0.07
1.90	1.13	13.16	0.30	-5.96	0.07
2.00	1.15	12.75	0.31	-22.92	0.07
2.20	1.19	12.01	0.34	-53.71	0.07
2.50	1.26	11.02	0.38	-92.04	0.08
3.00	1.38	9.68	0.43	-135.03	0.10
3.50	1.50	8.62	0.49	-151.89	0.13
4.00	1.64	7.76	0.53	-142.61	0.20
4.50	1.78	7.06	0.57	-107.21	0.32
V _C = 2 V, I _C = 20 mA					
0.90	1.19	20.04	0.28	-174.55	0.08
1.00	1.20	19.10	0.29	-172.87	0.08
1.20	1.22	17.64	0.30	-169.46	0.08
1.50	1.26	15.89	0.32	-164.18	0.08
1.70	1.29	14.88	0.34	-160.56	0.08
1.90	1.32	13.98	0.35	-156.86	0.09
2.00	1.33	13.56	0.36	-154.97	0.09
2.20	1.37	12.78	0.38	-151.14	0.09
2.50	1.42	11.75	0.40	-145.23	0.10
3.00	1.51	10.34	0.44	-134.97	0.13
3.50	1.61	9.22	0.48	-124.18	0.18
4.00	1.72	8.32	0.52	-112.87	0.25
4.50	1.83	7.57	0.56	-101.03	0.35

TYPICAL PERFORMANCE CURVES ($T_A = 25^\circ\text{C}$)

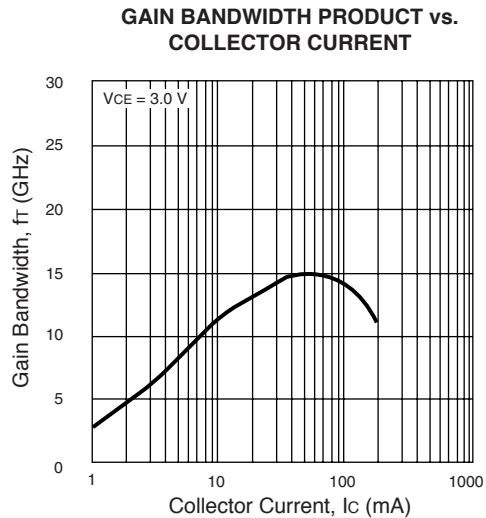
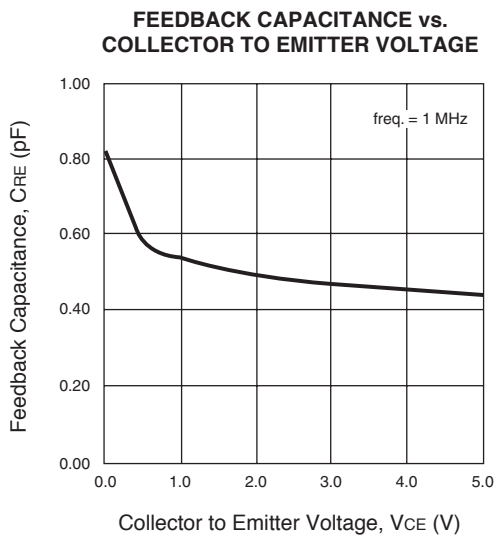
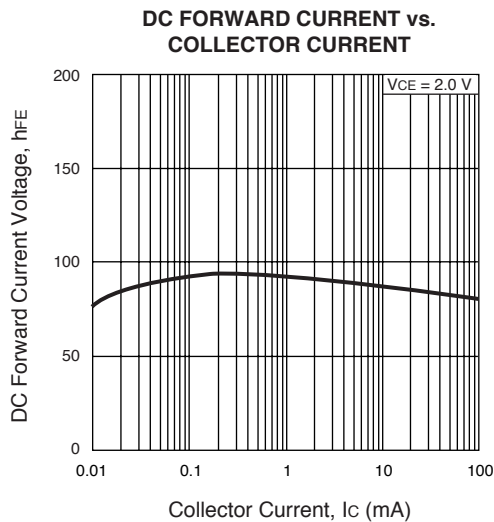
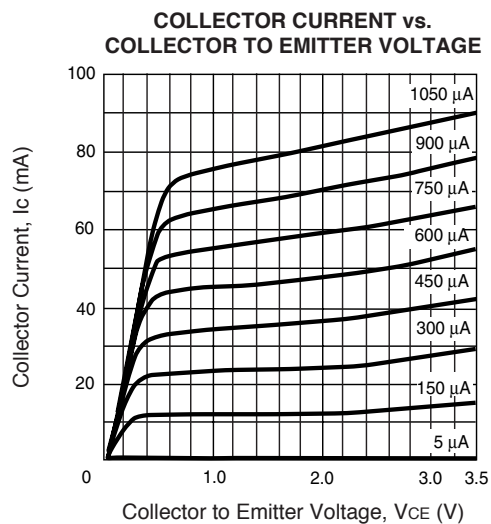
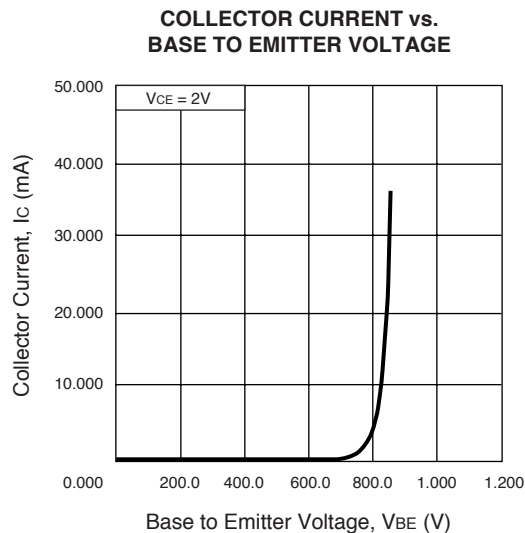
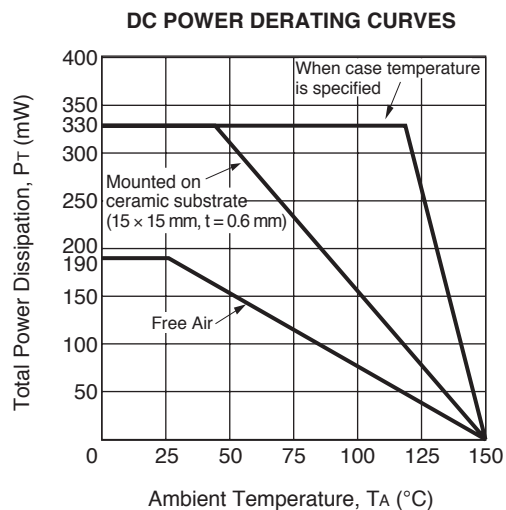

TYPICAL PERFORMANCE CURVES (T_A = 25°C)

MAXIMUM STABLE GAIN, INSERTION POWER GAIN, MAXIMUM AVAILABLE GAIN vs. FREQUENCY

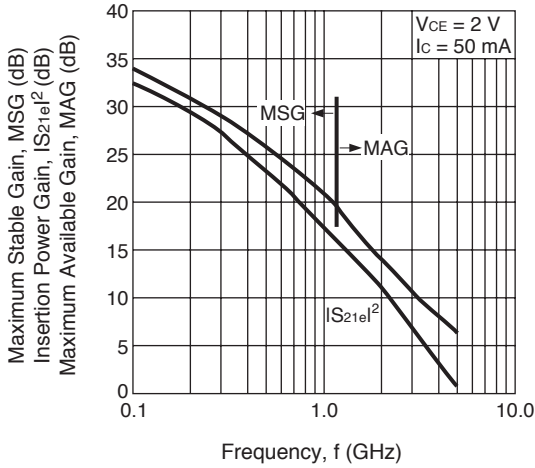

MAXIMUM STABLE GAIN, INSERTION POWER GAIN, MAXIMUM AVAILABLE GAIN vs. COLLECTOR CURRENT

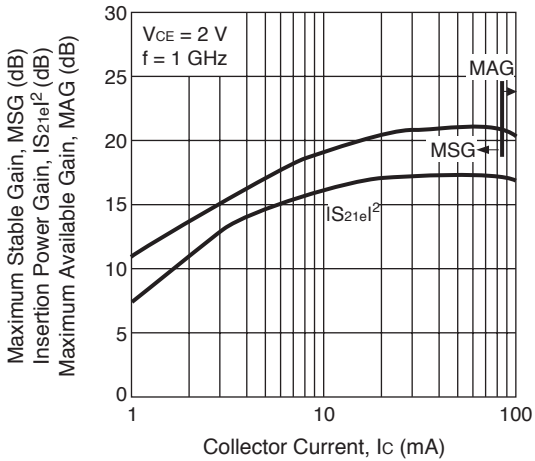

MAXIMUM STABLE GAIN, INSERTION POWER GAIN, MAXIMUM AVAILABLE GAIN vs. COLLECTOR CURRENT

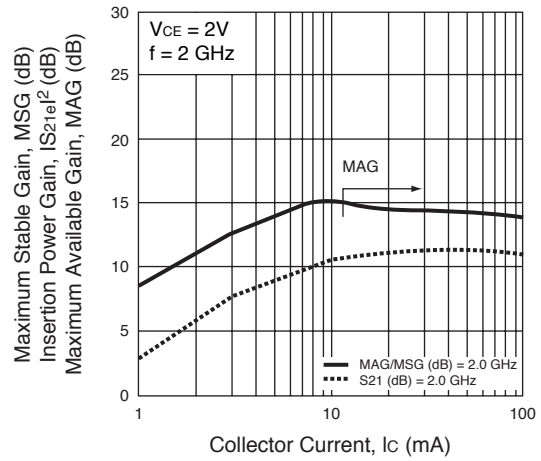

OUTPUT POWER COLLECTOR CURRENT vs. INPUT POWER

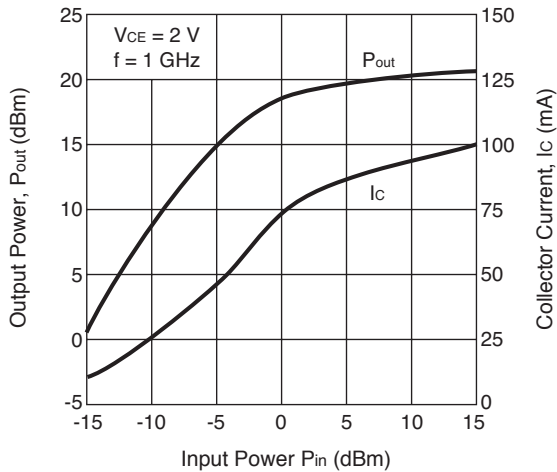

OUTPUT POWER COLLECTOR CURRENT vs. INPUT POWER

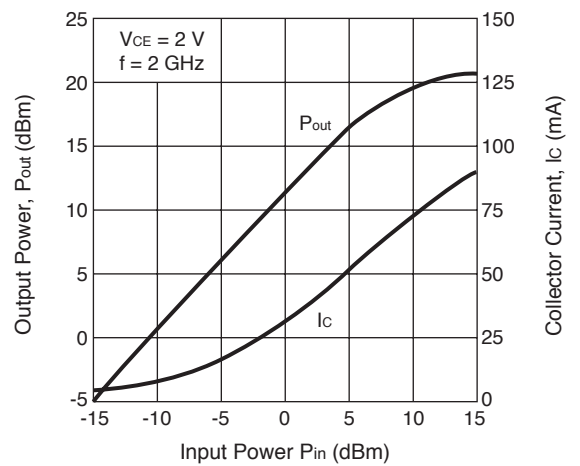

TYPICAL PERFORMANCE CURVES (T_A = 25°C)

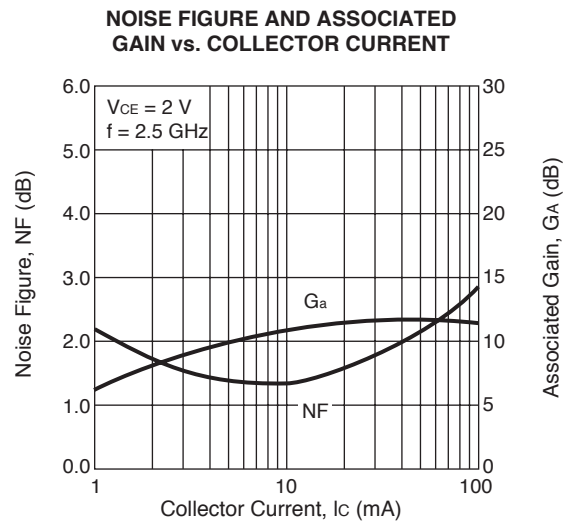
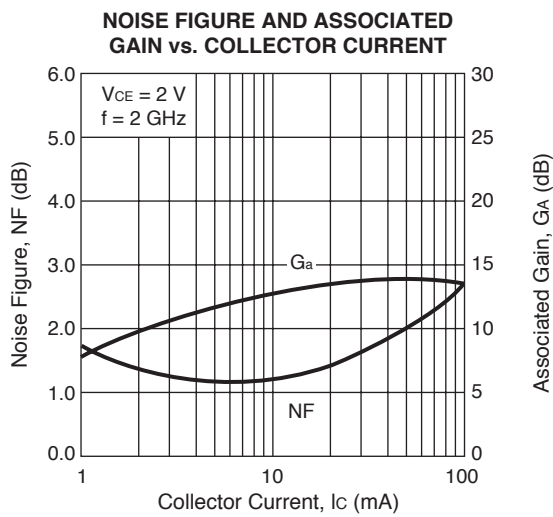
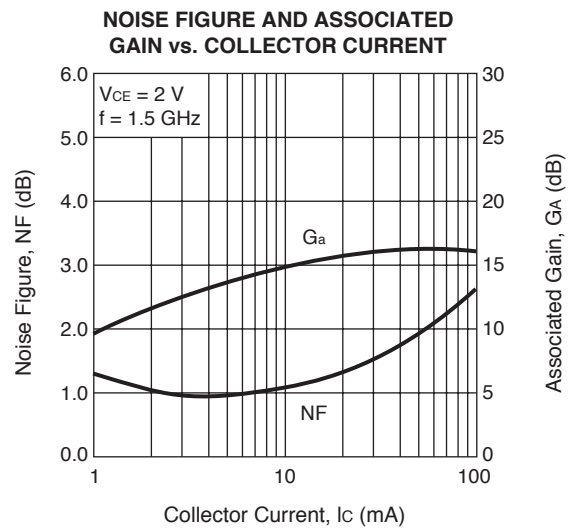
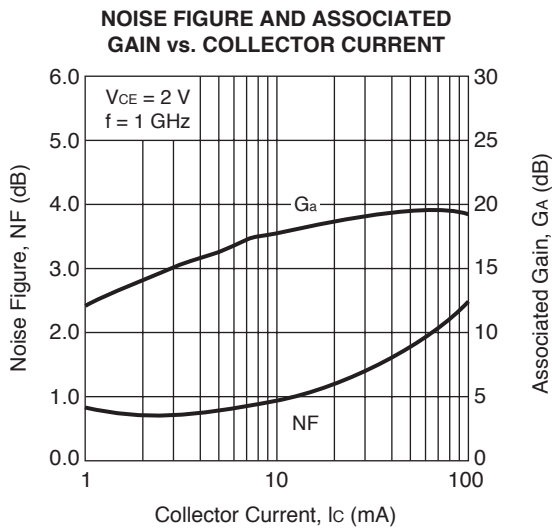

NE663M04

TYPICAL SCATTERING PARAMETERS (T_A = 25°C)

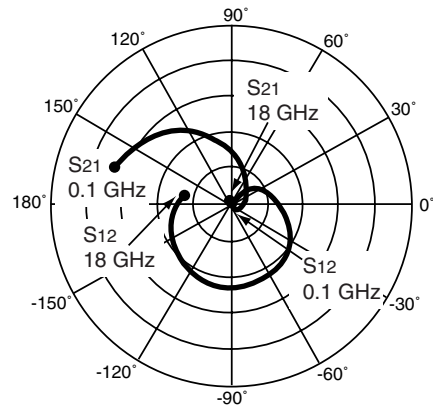
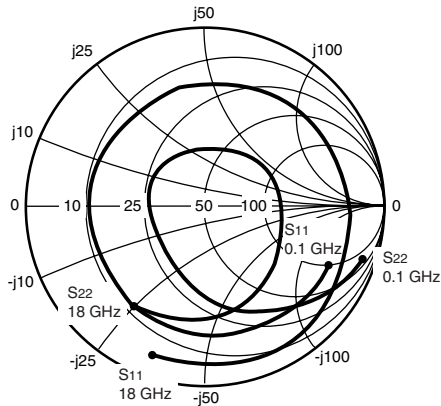

NE663M04

V_c = 2 V, I_c = 5 mA

FREQUENCY	S ₁₁		S ₂₁		S ₁₂		S ₂₂		K	MAG ¹
GHz	MAG	ANG	MAG	ANG	MAG	ANG	MAG	ANG		(dB)
0.10	0.797	-25.94	13.442	161.76	0.028	72.37	0.936	-20.39	0.11	26.75
0.20	0.770	-51.57	12.398	147.44	0.051	59.73	0.851	-37.40	0.12	23.88
0.30	0.745	-73.20	11.178	135.11	0.067	49.51	0.760	-51.45	0.14	22.24
0.40	0.722	-91.15	10.009	124.78	0.078	41.79	0.679	-63.07	0.17	21.10
0.50	0.706	-106.11	8.939	116.19	0.085	35.66	0.613	-72.68	0.21	20.20
0.70	0.686	-128.20	7.164	102.82	0.095	27.05	0.517	-87.63	0.28	18.79
1.00	0.671	-150.55	5.409	88.20	0.101	19.02	0.434	-103.18	0.39	17.27
1.50	0.645	-176.33	3.740	70.86	0.105	12.58	0.345	-122.09	0.64	15.51
2.00	0.645	165.19	2.883	56.19	0.109	8.59	0.317	-134.76	0.82	14.21
2.50	0.650	149.02	2.346	42.81	0.113	5.53	0.304	-145.44	0.98	13.16
3.00	0.658	134.45	1.973	30.27	0.118	2.95	0.296	-155.25	1.11	10.18
3.50	0.672	121.30	1.702	18.51	0.123	0.37	0.293	-165.24	1.21	8.63
4.00	0.687	109.32	1.495	7.29	0.130	-2.38	0.294	-175.12	1.28	7.47
5.00	0.714	88.23	1.204	-13.63	0.145	-8.89	0.308	165.47	1.33	5.74
6.00	0.732	69.35	1.010	-32.90	0.164	-17.02	0.325	148.83	1.35	4.38
7.00	0.748	48.25	0.872	-52.12	0.184	-28.42	0.331	130.26	1.35	3.21
8.00	0.771	28.05	0.756	-70.66	0.201	-41.05	0.330	107.54	1.36	2.15
9.00	0.803	11.98	0.658	-88.06	0.215	-54.78	0.334	80.84	1.33	1.40
10.00	0.831	-1.70	0.582	-104.40	0.227	-68.60	0.361	54.14	1.29	0.84
11.00	0.850	-15.13	0.516	-120.66	0.233	-83.30	0.397	28.30	1.30	0.15
12.00	0.868	-30.05	0.460	-137.97	0.237	-99.71	0.438	1.90	1.30	-0.41
13.00	0.880	-46.23	0.399	-155.64	0.229	-117.00	0.483	-23.26	1.38	-1.27
14.00	0.891	-61.26	0.336	-172.84	0.212	-133.32	0.538	-47.62	1.53	-2.27
15.00	0.896	-72.09	0.282	-171.65	0.194	-148.20	0.591	-70.54	1.71	-3.29
16.00	0.895	-83.61	0.237	-156.87	0.178	-162.18	0.634	-89.80	1.99	-4.45
17.00	0.887	-96.20	0.201	-141.03	0.161	-177.56	0.657	-107.95	2.47	-5.78
18.00	0.887	-107.53	0.163	-124.81	0.140	-168.44	0.677	-126.87	3.12	-7.17

Note:

1. Gain Calculations:

$$MAG = \frac{|S_{21}|}{|S_{12}|} \left(K \pm \sqrt{K^2 - 1} \right). \text{ When } K \leq 1, \text{ MAG is undefined and MSG values are used. } MSG = \frac{|S_{21}|}{|S_{12}|}, K = \frac{1 + |\Delta|^2 - |S_{11}|^2 - |S_{22}|^2}{2 |S_{12}| |S_{21}|}, \Delta = S_{11} S_{22} - S_{21} S_{12}$$

MAG = Maximum Available Gain

MSG = Maximum Stable Gain

TYPICAL SCATTERING PARAMETERS (T_A = 25°C)

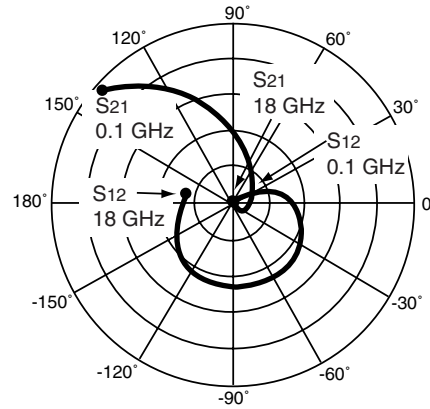
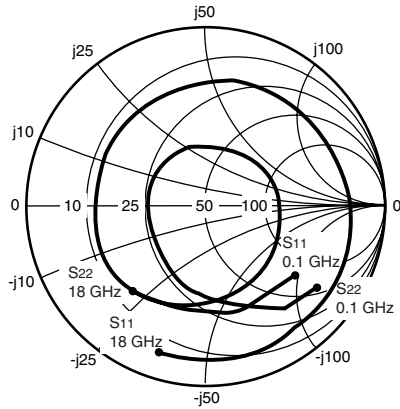

NE663M04

V_c = 2 V, I_c = 10 mA

FREQUENCY	S ₁₁		S ₂₁		S ₁₂		S ₂₂		K	MAG ¹
GHz	MAG	ANG	MAG	ANG	MAG	ANG	MAG	ANG		(dB)
0.10	0.663	-39.80	22.325	156.42	0.025	68.46	0.888	-30.08	0.14	29.44
0.20	0.648	-74.35	19.316	138.74	0.042	53.94	0.764	-53.61	0.17	26.62
0.30	0.643	-99.34	16.280	125.39	0.052	44.43	0.656	-71.64	0.22	24.92
0.40	0.640	-117.52	13.770	115.35	0.059	38.32	0.576	-85.71	0.28	23.70
0.50	0.639	-131.00	11.784	107.56	0.063	34.20	0.519	-96.85	0.34	22.72
0.70	0.639	-149.50	9.001	95.98	0.069	29.58	0.447	-113.49	0.44	21.17
1.00	0.638	-167.32	6.570	83.55	0.075	26.56	0.393	-129.82	0.58	19.41
1.50	0.628	171.19	4.472	68.88	0.085	25.54	0.339	-150.16	0.84	17.22
2.00	0.630	155.31	3.423	55.73	0.097	23.71	0.322	-162.53	0.97	15.49
2.50	0.635	140.87	2.776	43.46	0.109	20.80	0.313	-172.93	1.06	12.52
3.00	0.642	127.61	2.332	31.80	0.121	17.00	0.307	177.37	1.13	10.65
3.50	0.655	115.61	2.012	20.76	0.133	12.48	0.305	167.60	1.17	9.30
4.00	0.668	104.45	1.768	10.11	0.145	7.36	0.306	158.01	1.19	8.21
5.00	0.694	84.64	1.431	-10.04	0.168	-3.63	0.314	139.70	1.21	6.54
6.00	0.708	66.65	1.210	-28.98	0.189	-15.48	0.316	124.07	1.22	5.21
7.00	0.723	46.29	1.052	-48.29	0.208	-29.47	0.314	106.12	1.24	4.10
8.00	0.747	26.80	0.919	-67.26	0.221	-43.85	0.314	83.51	1.26	3.13
9.00	0.782	11.39	0.804	-85.30	0.230	-58.50	0.324	57.54	1.25	2.45
10.00	0.813	-1.86	0.713	-102.35	0.235	-72.67	0.353	33.08	1.23	1.95
11.00	0.835	-15.02	0.632	-119.34	0.236	-87.18	0.389	9.93	1.24	1.33
12.00	0.857	-29.76	0.565	-137.39	0.235	-103.15	0.427	-13.90	1.23	0.89
13.00	0.872	-45.91	0.492	-155.92	0.224	-119.67	0.469	-36.48	1.30	0.13
14.00	0.886	-60.93	0.416	-173.96	0.206	-135.20	0.519	-58.27	1.41	-0.76
15.00	0.894	-71.77	0.351	169.70	0.188	-149.43	0.567	-78.83	1.56	-1.71
16.00	0.894	-83.36	0.297	153.76	0.172	-162.57	0.604	-96.31	1.80	-2.82
17.00	0.887	-95.98	0.253	136.63	0.156	-177.56	0.623	-113.08	2.20	-4.11
18.00	0.889	-107.33	0.210	119.39	0.137	168.86	0.641	-130.90	2.73	-5.36

Note:

1. Gain Calculations:

$$MAG = \frac{|S_{21}|}{|S_{12}|} (K \pm \sqrt{K^2 - 1}). \text{ When } K \leq 1, \text{ MAG is undefined and MSG values are used. } MSG = \frac{|S_{21}|}{|S_{12}|}, K = \frac{1 + |\Delta|^2 - |S_{11}|^2 - |S_{22}|^2}{2 |S_{12}| |S_{21}|}, \Delta = S_{11} S_{22} - S_{21} S_{12}$$

MAG = Maximum Available Gain

MSG = Maximum Stable Gain

NE663M04

TYPICAL SCATTERING PARAMETERS (T_A = 25°C)

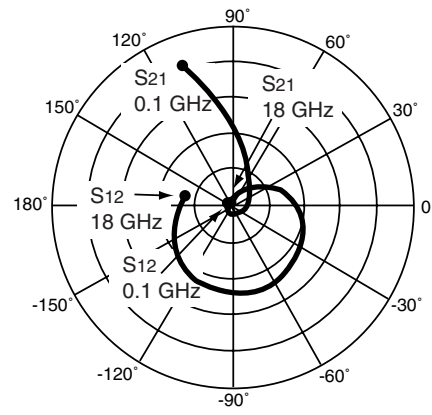
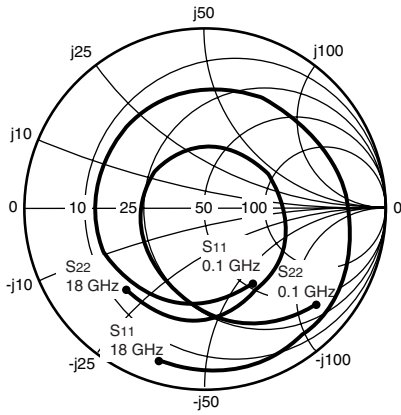

NE663M04

V_c = 2 V, I_c = 20 mA

FREQUENCY	S ₁₁		S ₂₁		S ₁₂		S ₂₂		K	MAG ¹
GHz	MAG	ANG	MAG	ANG	MAG	ANG	MAG	ANG		(dB)
0.10	0.511	-62.59	32.668	149.99	0.021	64.28	0.820	-41.69	0.21	31.84
0.20	0.556	-103.21	25.795	129.89	0.033	49.87	0.675	-71.53	0.27	28.96
0.30	0.588	-126.41	20.293	116.89	0.039	42.91	0.576	-92.40	0.35	27.15
0.40	0.604	-141.09	16.427	107.92	0.043	39.62	0.515	-107.59	0.43	25.81
0.50	0.614	-151.41	13.687	101.21	0.046	38.01	0.477	-118.94	0.51	24.69
0.70	0.624	-165.36	10.178	91.28	0.052	37.25	0.434	-134.83	0.63	22.90
1.00	0.628	-179.16	7.310	80.49	0.061	37.63	0.403	-149.46	0.78	20.80
1.50	0.626	162.65	4.944	67.58	0.076	38.22	0.374	-167.86	0.96	18.11
2.00	0.627	148.54	3.773	55.43	0.094	35.57	0.364	-178.99	1.04	14.83
2.50	0.632	135.29	3.056	43.88	0.111	31.04	0.358	171.39	1.08	12.66
3.00	0.637	122.90	2.565	32.81	0.128	25.47	0.354	162.03	1.11	10.99
3.50	0.649	111.59	2.212	22.25	0.143	19.40	0.353	152.55	1.13	9.72
4.00	0.662	101.04	1.945	12.02	0.157	12.86	0.355	143.21	1.14	8.67
5.00	0.684	82.04	1.577	-7.51	0.183	-0.54	0.362	125.05	1.15	7.02
6.00	0.696	64.55	1.340	-26.09	0.206	-14.22	0.358	108.76	1.16	5.71
7.00	0.709	44.69	1.171	-45.24	0.225	-29.64	0.353	90.45	1.18	4.63
8.00	0.733	25.69	1.026	-64.24	0.237	-45.10	0.354	67.93	1.19	3.70
9.00	0.768	10.70	0.901	-82.45	0.242	-60.56	0.368	42.82	1.19	3.06
10.00	0.800	-2.20	0.800	-99.73	0.243	-75.22	0.399	19.74	1.18	2.56
11.00	0.824	-15.12	0.712	-116.86	0.241	-89.93	0.431	-2.13	1.20	2.02
12.00	0.847	-29.73	0.640	-135.11	0.237	-105.89	0.465	-24.80	1.20	1.64
13.00	0.865	-45.76	0.559	-153.83	0.223	-122.16	0.501	-46.12	1.25	0.97
14.00	0.881	-60.72	0.477	-172.03	0.202	-137.26	0.543	-66.63	1.35	0.20
15.00	0.890	-71.56	0.405	171.44	0.184	-150.97	0.582	-85.93	1.48	-0.66
16.00	0.892	-83.14	0.347	155.32	0.168	-163.59	0.609	-102.49	1.67	-1.64
17.00	0.886	-95.81	0.300	137.77	0.152	-178.14	0.619	-118.53	2.02	-2.83
18.00	0.889	-107.13	0.252	120.16	0.133	168.73	0.630	-135.64	2.47	-3.97

Note:

1. Gain Calculations:

$$MAG = \frac{|S_{21}|}{|S_{12}|} (K \pm \sqrt{K^2 - 1}). \text{ When } K \leq 1, \text{ MAG is undefined and MSG values are used. } MSG = \frac{|S_{21}|}{|S_{12}|}, K = \frac{1 + |\Delta|^2 - |S_{11}|^2 - |S_{22}|^2}{2 |S_{12} S_{21}|}, \Delta = S_{11} S_{22} - S_{21} S_{12}$$

MAG = Maximum Available Gain

MSG = Maximum Stable Gain

TYPICAL SCATTERING PARAMETERS (TA = 25°C)

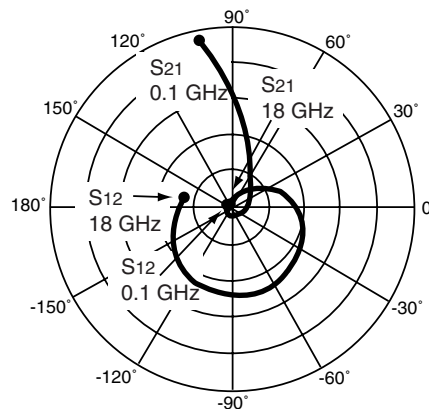
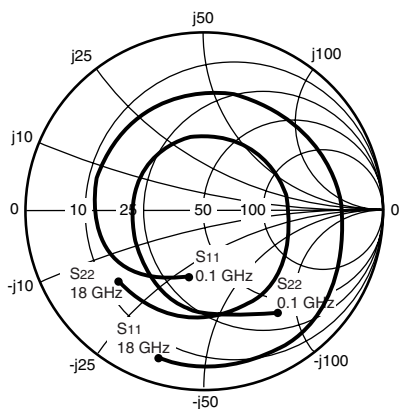

NE663M04

Vc = 2 V, Ic = 50 mA

FREQUENCY	S11		S21		S12		S22		K	MAG ¹
GHz	MAG	ANG	MAG	ANG	MAG	ANG	MAG	ANG		(dB)
0.10	0.398	-104.22	42.854	142.81	0.016	60.32	0.721	-56.00	0.35	34.22
0.20	0.528	-136.04	30.624	121.99	0.023	50.18	0.592	-91.52	0.44	31.16
0.30	0.582	-151.58	22.856	110.09	0.028	47.02	0.524	-113.47	0.55	29.13
0.40	0.606	-161.14	18.001	102.32	0.031	46.92	0.490	-127.93	0.65	27.59
0.50	0.618	-167.97	14.776	96.56	0.035	47.65	0.471	-138.01	0.73	26.27
0.70	0.629	-177.73	10.827	87.94	0.042	49.21	0.450	-151.36	0.84	24.09
1.00	0.632	171.83	7.710	78.32	0.054	50.09	0.435	-163.25	0.93	21.57
1.50	0.634	156.26	5.203	66.66	0.074	49.10	0.421	-178.94	1.03	17.40
2.00	0.634	143.48	3.966	55.19	0.095	44.36	0.414	171.12	1.06	14.70
2.50	0.636	131.11	3.209	44.16	0.115	38.10	0.409	162.15	1.08	12.74
3.00	0.641	119.35	2.693	33.49	0.134	31.08	0.406	153.18	1.09	11.18
3.50	0.651	108.53	2.323	23.27	0.151	23.78	0.407	144.04	1.10	9.95
4.00	0.662	98.35	2.043	13.34	0.167	16.32	0.409	134.90	1.10	8.91
5.00	0.683	79.90	1.658	-5.70	0.195	1.47	0.417	116.89	1.11	7.28
6.00	0.692	62.75	1.414	-23.95	0.219	-13.32	0.412	100.10	1.12	5.98
7.00	0.703	43.23	1.238	-42.94	0.238	-29.58	0.406	81.52	1.14	4.92
8.00	0.726	24.55	1.087	-61.84	0.249	-45.81	0.410	59.26	1.15	4.02
9.00	0.761	9.96	0.958	-80.05	0.252	-61.86	0.427	34.83	1.16	3.39
10.00	0.793	-2.68	0.851	-97.33	0.252	-77.02	0.458	12.49	1.15	2.91
11.00	0.817	-15.44	0.759	-114.45	0.246	-91.95	0.488	-8.86	1.17	2.39
12.00	0.841	-29.91	0.683	-132.67	0.240	-108.07	0.519	-31.12	1.17	2.04
13.00	0.860	-45.82	0.599	-151.26	0.223	-124.29	0.550	-51.98	1.22	1.46
14.00	0.877	-60.78	0.513	-169.35	0.201	-139.20	0.587	-72.02	1.30	0.78
15.00	0.887	-71.51	0.439	174.30	0.181	-152.74	0.617	-90.88	1.41	0.01
16.00	0.890	-83.09	0.380	158.28	0.165	-164.85	0.636	-107.22	1.59	-0.88
17.00	0.885	-95.69	0.333	140.87	0.149	-179.20	0.638	-123.13	1.88	-1.93
18.00	0.888	-107.06	0.283	123.27	0.130	168.05	0.641	-140.04	2.28	-2.97

Note:

1. Gain Calculations:

$$MAG = \frac{|S_{21}|}{|S_{12}|} \left(K \pm \sqrt{K^2 - 1} \right). \text{ When } K \leq 1, \text{ MAG is undefined and MSG values are used. } MSG = \frac{|S_{21}|}{|S_{12}|}, K = \frac{1 + |\Delta|^2 - |S_{11}|^2 - |S_{22}|^2}{2 |S_{12}| |S_{21}|}, \Delta = S_{11} S_{22} - S_{21} S_{12}$$

MAG = Maximum Available Gain

MSG = Maximum Stable Gain

Life Support Applications

These NEC products are not intended for use in life support devices, appliances, or systems where the malfunction of these products can reasonably be expected to result in personal injury. The customers of CEL using or selling these products for use in such applications do so at their own risk and agree to fully indemnify CEL for all damages resulting from such improper use or sale.

EXCLUSIVE NORTH AMERICAN AGENT FOR NEC RF, MICROWAVE & OPTOELECTRONIC SEMICONDUCTORS

CEL CALIFORNIA EASTERN LABORATORIES • Headquarters • 4590 Patrick Henry Drive • Santa Clara, CA 95054-1817 • (408) 988-3500 • Telex 34-6393 • FAX (408) 988-0279

DATA SUBJECT TO CHANGE WITHOUT NOTICE

Internet: <http://WWW.CEL.COM>

01/16/2002

Subject: Compliance with EU Directives

CEL certifies, to its knowledge, that semiconductor and laser products detailed below are compliant with the requirements of European Union (EU) Directive 2002/95/EC Restriction on Use of Hazardous Substances in electrical and electronic equipment (RoHS) and the requirements of EU Directive 2003/11/EC Restriction on Penta and Octa BDE.

CEL Pb-free products have the same base part number with a suffix added. The suffix –A indicates that the device is Pb-free. The –AZ suffix is used to designate devices containing Pb which are exempted from the requirement of RoHS directive (*). In all cases the devices have Pb-free terminals. All devices with these suffixes meet the requirements of the RoHS directive.

This status is based on CEL’s understanding of the EU Directives and knowledge of the materials that go into its products as of the date of disclosure of this information.

Restricted Substance per RoHS	Concentration Limit per RoHS (values are not yet fixed)	Concentration contained in CEL devices	
		-A	-AZ
Lead (Pb)	< 1000 PPM	Not Detected	(*)
Mercury	< 1000 PPM	Not Detected	
Cadmium	< 100 PPM	Not Detected	
Hexavalent Chromium	< 1000 PPM	Not Detected	
PBB	< 1000 PPM	Not Detected	
PBDE	< 1000 PPM	Not Detected	

If you should have any additional questions regarding our devices and compliance to environmental standards, please do not hesitate to contact your local representative.

Important Information and Disclaimer: Information provided by CEL on its website or in other communications concerning the substance content of its products represents knowledge and belief as of the date that it is provided. CEL bases its knowledge and belief on information provided by third parties and makes no representation or warranty as to the accuracy of such information. Efforts are underway to better integrate information from third parties. CEL has taken and continues to take reasonable steps to provide representative and accurate information but may not have conducted destructive testing or chemical analysis on incoming materials and chemicals. CEL and CEL suppliers consider certain information to be proprietary, and thus CAS numbers and other limited information may not be available for release.

In no event shall CEL’s liability arising out of such information exceed the total purchase price of the CEL part(s) at issue sold by CEL to customer on an annual basis.

See CEL Terms and Conditions for additional clarification of warranties and liability.