

Low-Power 3.3V-Supply Full-Duplex RS-485 Driver/Receiver

Check for Samples: [SN65HVD37](#)

FEATURES

- **Low-Current Standby Mode:** <1 μ A Typical
- **Operational Quiescent Current** < 1 mA
- **High Receiver Hysteresis for Noise Immunity (60 mV Typical)**
- **1/8 Unit-Load (Up to 256 Nodes on the Bus)**
- **Bus-pin ESD Protection Exceeds 15 kV HBM**
- **Driver Output Transition Times Optimized for Signaling Rate up to 20 Mbps**
- **Glitch-Free Power-Up and Power-Down Protection for Hot-Plugging Applications**
- **5V-Tolerant Logic Inputs**
- **Bus Idle, Open, and Short-Circuit Failsafe**
- **Driver Current Limiting and Thermal Shutdown**
- **Fully Meets All TIA-485-A Specifications**

APPLICATIONS

- **Telecommunications Equipment**
- **Industrial Automation**
- **Process Automation**
- **Building Automation**
- **Point-of-Sale (POS) Terminals**
- **Improved Replacement for ADM3076, ADM3491, LTC2852, MAX3491 and SP3491**

DESCRIPTION

The SN65HVD37 combines a robust differential driver and a receiver with high noise immunity for demanding industrial applications. The driver differential outputs and the receiver differential inputs are separate pins, to form a bus port for full-duplex (four-wire) communications. The driver and receiver can be independently enabled, and feature a wide common-mode voltage range, making this device suitable for multi-point applications over long cable runs. The SN65HVD37 is characterized over the temperature range of -40°C to 85°C .

D PACKAGE (TOP VIEW)

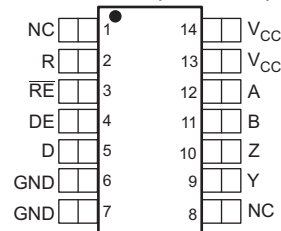

NC - No internal connection

LOGIC DIAGRAM (POSITIVE LOGIC)

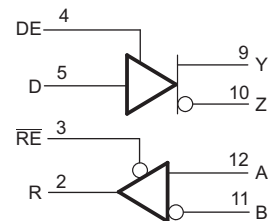

Figure 1. 60 mV Receiver Hysteresis for Noise Immunity



Please be aware that an important notice concerning availability, standard warranty, and use in critical applications of Texas Instruments semiconductor products and disclaimers thereto appears at the end of this data sheet.



These devices have limited built-in ESD protection. The leads should be shorted together or the device placed in conductive foam during storage or handling to prevent electrostatic damage to the MOS gates.

ABSOLUTE MAXIMUM RATINGS⁽¹⁾

		VALUE/UNITS
V_{CC}	Supply voltage	–0.5 V to 7 V
	Voltage range at A, B, Y, Z pins	–13 V to 13 V
	Input voltage range at any logic pin	–0.3 V to 5.7 V
	Voltage range, transient pulse, A, B, Y, Z, through 100 Ω	–25 V to 25 V
	Receiver output current	–24 mA to 24 mA
T_J	Junction temperature	170°C
	Continuous total power dissipation	(see Thermal Table)
	IEC 60749-26 ESD (Human Body Model), bus terminals and GND	± 16 kV
JEDEC Standard 22	Test Method A114 (Human Body Model), all pins	± 5 kV
	Test Method C101 (Charged Device Model), all pins	± 1.5 kV
JEDEC Standard 22	Test Method A115 (Machine Model), all pins	± 150 V

- (1) Stresses beyond those listed under "absolute maximum ratings" may cause permanent damage to the device. These are stress ratings only and functional operation of the device at these or any other conditions beyond those indicated under "recommended operating conditions" is not implied. Exposure to absolute-maximum-rated conditions for extended periods may affect device reliability.

THERMAL INFORMATION

THERMAL METRIC ⁽¹⁾		SN65HVD37	UNITS
		D	
		14 PINS	
θ_{JA}	Junction-to-ambient thermal resistance	79.3	°C/W
θ_{JCTop}	Junction-to-case (top) thermal resistance	44.8	
θ_{JB}	Junction-to-board thermal resistance	33.5	
Ψ_{JT}	Junction-to-top characterization parameter	13.3	
Ψ_{JB}	Junction-to-board characterization parameter	33.3	

- (1) For more information about traditional and new thermal metrics, see the *IC Package Thermal Metrics* application report, [SPRA953](#).

RECOMMENDED OPERATING CONDITIONS

		MIN	NOM	MAX	UNIT
V_{CC}	Supply voltage ⁽¹⁾	3	3.3	3.6	V
V_I	Input voltage at any bus terminal (separately or common mode) ⁽²⁾	–7		12	V
V_{IH}	High-level input voltage (Driver, driver enable, and receiver enable inputs)	2		V_{CC}	V
V_{IL}	Low-level input voltage (Driver, driver enable, and receiver enable inputs)	0		0.8	V
V_{ID}	Differential input voltage	–12		12	V
I_O	Output current	Driver		60	mA
		Receiver	–8	8	
R_L	Differential load resistance	54	60		Ω
C_L	Differential load capacitance		50		pF
	Signaling rate		HVD37	20	Mbps
T_A	Operating free-air temperature (See application section for thermal information)	–40		85	°C
T_J	Junction Temperature	–40		150	°C

- (1) Both pins 13 and 14 should be connected to the supply voltage; both pins 6 and 7 should be connected to ground.
 (2) The algebraic convention, in which the least positive (most negative) limit is designated as minimum is used in this data sheet.

ELECTRICAL CHARACTERISTICS

over recommended operating conditions (unless otherwise noted)

PARAMETER		TEST CONDITIONS		MIN	TYP	MAX	UNIT
V _{OD}	Driver differential output voltage magnitude	See Figure 1, R _L = 60 Ω, V _{CC} ≥ 3.15 V, 375 Ω on each output to –7 V to 12 V		1.5	1.9		V
		R _L = 54 Ω (RS-485)	See Figure 3	1.5	2		V
		R _L = 100 Ω (RS-422), T _J ≥ 25°C, V _{CC} ≥ 3.3 V		2	2.2		V
Δ V _{OD}	Change in magnitude of driver differential output voltage	R _L = 54 Ω, C _L = 50 pF		–0.1	0	0.1	V
V _{OC(SS)}	Steady-state common-mode output voltage	Center of two 27-Ω load resistors, C _L = 50 pF	See Figure 3	1.5	V _{CC} /2	2.5	V
ΔV _{OC}	Change in differential driver output common-mode voltage			–0.1	0	0.1	V
V _{OC(PP)}	Peak-to-peak driver common-mode output voltage			400			mV
C _{ID}	Differential input capacitance	A, B		3			pF
C _{OD}	Differential output capacitance	Y, Z		14			pF
V _{IT+}	Positive-going receiver differential input voltage threshold			See ⁽¹⁾	–60	–20	mV
V _{IT–}	Negative-going receiver differential input voltage threshold			–200	–120	See ⁽¹⁾	mV
V _{HYS}	Receiver differential input voltage threshold hysteresis (V _{IT+} – V _{IT–})			30	60		mV
V _{OH}	Receiver high-level output voltage	I _{OH} = –8 mA		2.4	V _{CC} – 0.3		V
V _{OL}	Receiver low-level output voltage	I _{OL} = 8 mA			0.2	0.4	V
I _I	Driver input, driver enable, and receiver enable input current			–2		2	μA
I _{OZ}	Receiver output high-impedance current	V _O = 0 V or V _{CC} , \overline{RE} at V _{CC}		–1		1	μA
I _{OS}	Driver short-circuit output current			–250		250	mA
I _I	Bus input current (disabled driver)	V _{CC} = 3 to 3.6 V or V _{CC} = 0 V, DE at 0 V	V _I = 12 V		75	125	μA
			V _I = –7 V	–100	–40		
I _{CC}	Supply current, steady-state, no load (quiescent)	Driver and Receiver enabled	DE = V _{CC} , RE = GND		720	850	μA
		Driver enabled, receiver disabled	DE = V _{CC} , RE = V _{CC}			400	μA
		Driver disabled, receiver enabled	DE = GND, RE = GND			800	μA
		Driver and receiver disabled (standby)	DE = GND, D = open, RE = V _{CC}	0.2	1	μA	
Supply current (dynamic)		See "TYPICAL CHARACTERISTICS" section					

 (1) Under any specific conditions, V_{IT+} is assured to be at least V_{HYS} higher than V_{IT–}.

SWITCHING CHARACTERISTICS

over recommended operating conditions (unless otherwise noted)

PARAMETER		TEST CONDITIONS	MIN	TYP	MAX	UNIT	
DRIVER							
t_r, t_f	Driver differential output rise/fall time	$R_L = 54 \Omega, C_L = 50 \text{ pF}$, See Figure 4	3	6	14	ns	
t_{PHL}, t_{PLH}	Driver propagation delay		10		20		
$t_{SK(P)}$	Driver pulse skew, $ t_{PHL} - t_{PLH} $				1		
t_{PHZ}, t_{PLZ}	Driver disable time	See Figure 5 and Figure 6	20		50	ns	
t_{PZH}, t_{PZL}	Driver enable time	Receiver enabled	8		25	ns	
		Receiver disabled	2.6		8	μs	
RECEIVER							
t_r, t_f	Receiver output rise/fall time	$C_L = 15 \text{ pF}$, See Figure 7	2	5	9	ns	
t_{PHL}, t_{PLH}	Receiver propagation delay time		40		50	75	ns
$t_{SK(P)}$	Receiver pulse skew, $ t_{PHL} - t_{PLH} $				2	5	ns
t_{PLZ}, t_{PHZ}	Receiver disable time		15		25	ns	
$t_{PZL(1)}, t_{PZH(1)}, t_{PZL(2)}, t_{PZH(2)}$	Receiver enable time	Driver enabled, See Figure 8	35		50	ns	
		Driver disabled, See Figure 8	3		8	μs	

DRIVER FUNCTION TABLE

INPUT	ENABLE	OUTPUTS		
		Y	Z	
H	H	H	L	Actively drive bus High
L	H	L	H	Actively drive bus Low
X	L	Z	Z	Driver disabled
X	OPEN	Z	Z	Driver disabled by default
OPEN	H	H	L	Actively drive bus High by default

RECEIVER FUNCTION TABLE

DIFFERENTIAL INPUT	ENABLE	OUTPUT	
$V_{ID} = V_A - V_B$	RE	R	
$V_{IT+} < V_{ID}$	L	H	Receive valid bus High
$V_{IT-} < V_{ID} < V_{IT+}$	L	?	Indeterminate bus state
$V_{ID} < V_{IT-}$	L	L	Receive valid bus Low
X	H	Z	Receiver disabled
X	OPEN	Z	Receiver disabled by default
Open-circuit bus	L	H	Fail-safe high output
Short-circuit bus	L	H	Fail-safe high output
Idle (terminated) bus	L	H	Fail-safe high output

EQUIVALENT INPUT AND OUTPUT SCHEMATIC DIAGRAMS

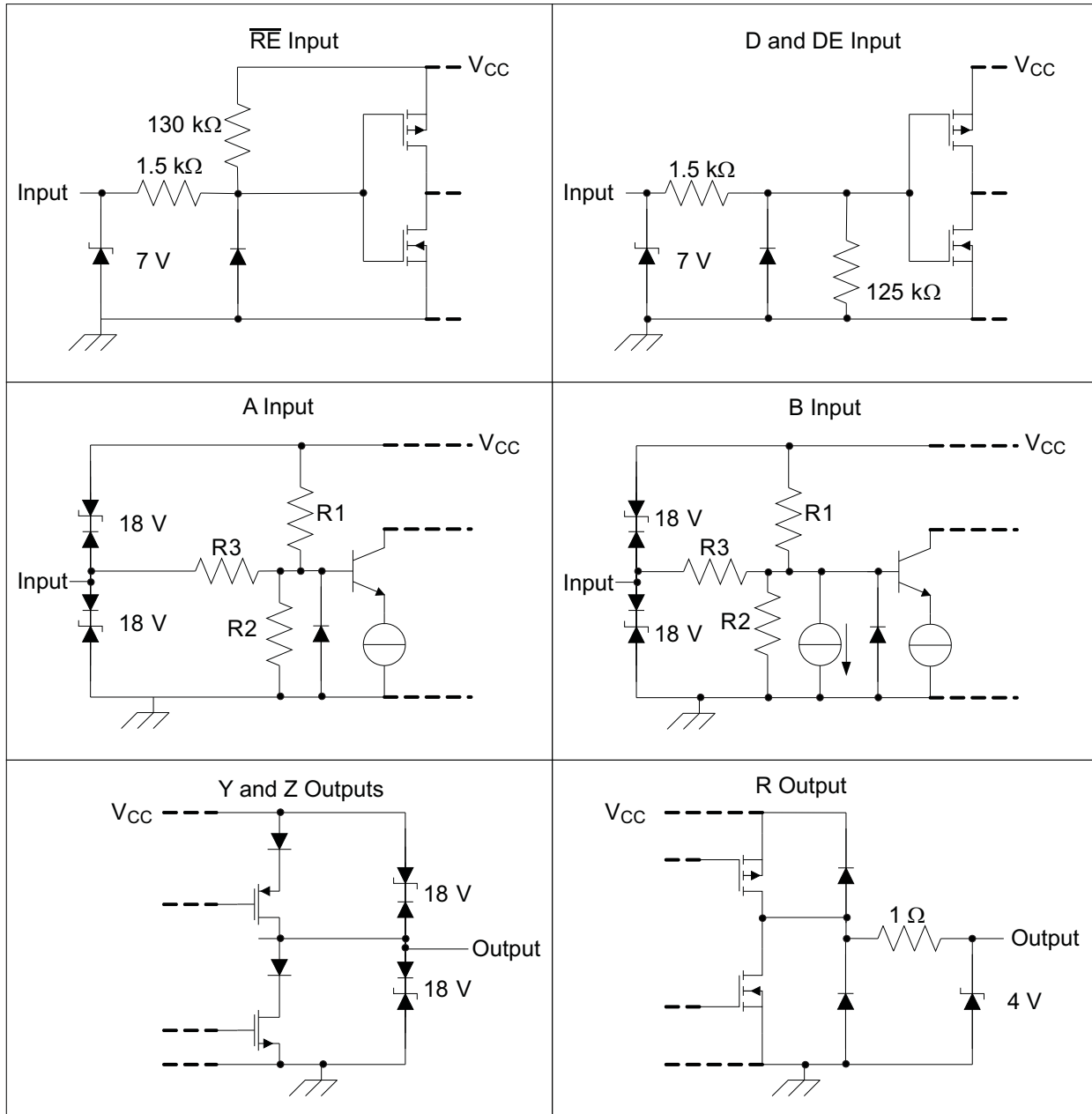

	R1/R2	R3
SN65HVD37	18 kΩ	190 kΩ

PARAMETER MEASUREMENT INFORMATION

Input generator rate is 100 kbps, 50% duty cycle, rise and fall times less than 6 nsec, output impedance 50 Ω

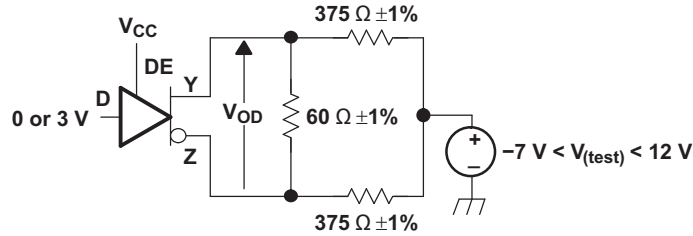

Figure 2. Measurement of Driver Differential Output Voltage With Common-mode Load

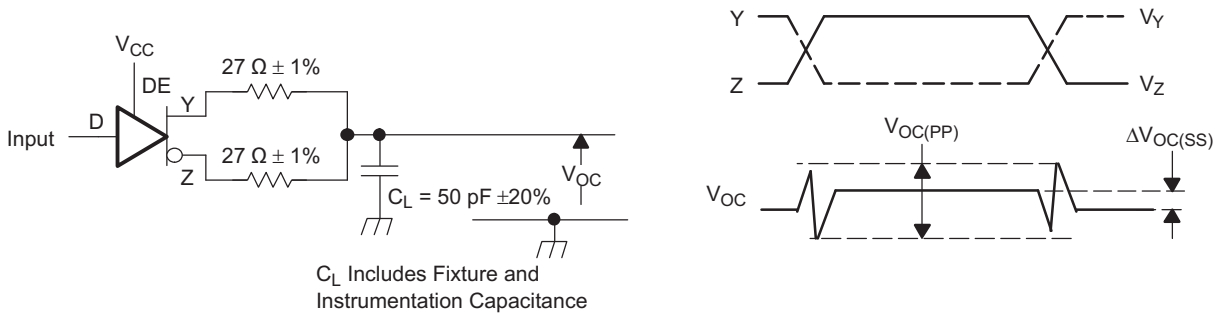

Figure 3. Measurement of Driver Differential and Common-mode Output with RS-485 Load

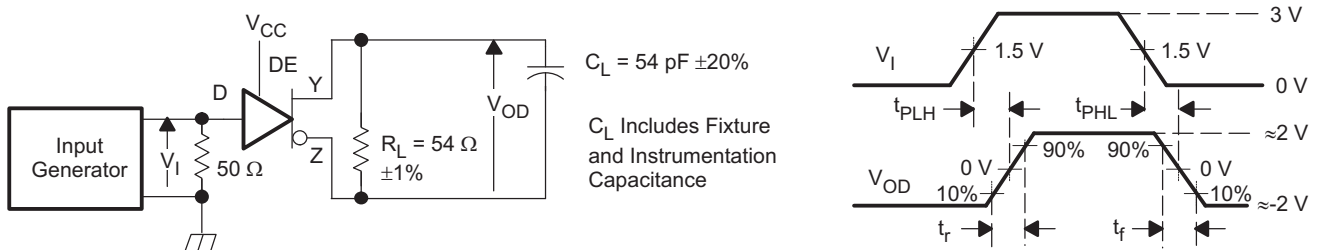
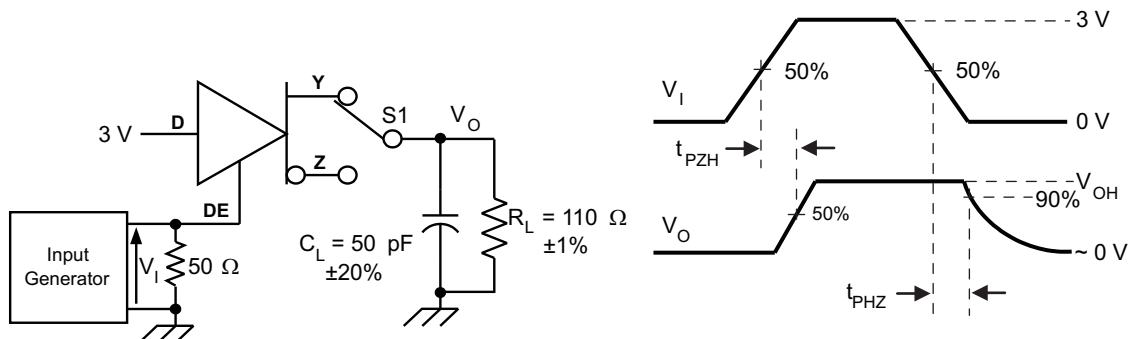

Figure 4. Measurement of Driver Differential Output Rise and Fall Times and Propagation Delays



NOTE: D at 3 V to test non-inverting output, D at 0 V to test inverting output.
 C_L includes Fixture and Instrumentation Capacitance

Figure 5. Measurement of Driver Enable and Disable Times with Active High Output and Pull-down Load

PARAMETER MEASUREMENT INFORMATION (continued)

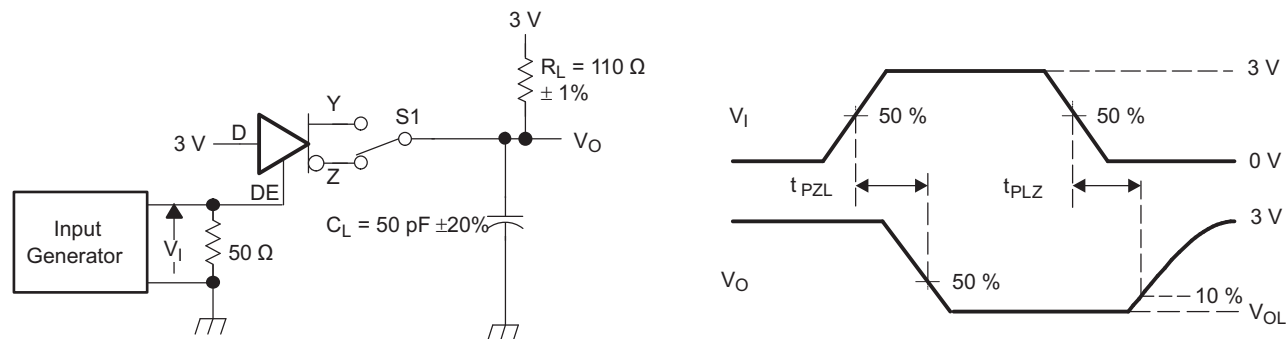

NOTE: D at 0 V to test non-inverting output, D at 3 V to test inverting output.

C_L Includes Fixture and Instrumentation Capacitance

Figure 6. Measurement of Driver Enable and Disable Times with Active Low Output and Pull-up Load

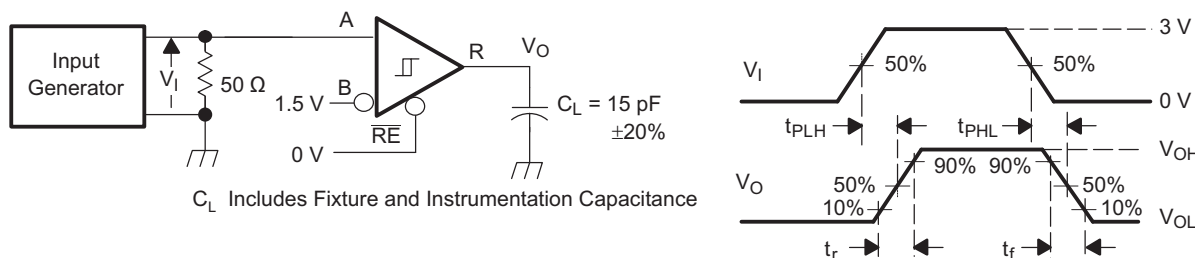

C_L Includes Fixture and Instrumentation Capacitance

Figure 7. Measurement of Receiver Output Rise and Fall Times and Propagation Delays

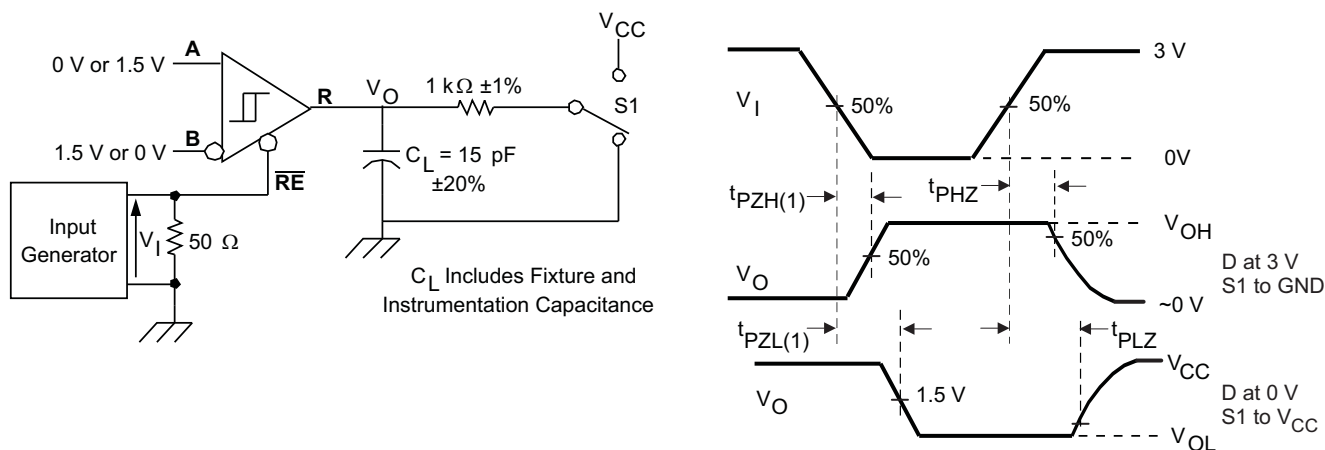

Figure 8. Measurement of Receiver Enable/Disable Times

TYPICAL CHARACTERISTICS

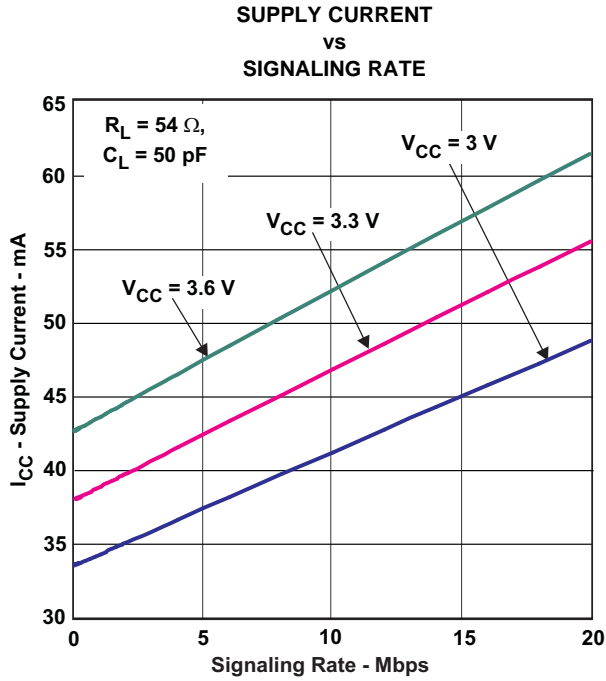

Figure 9.

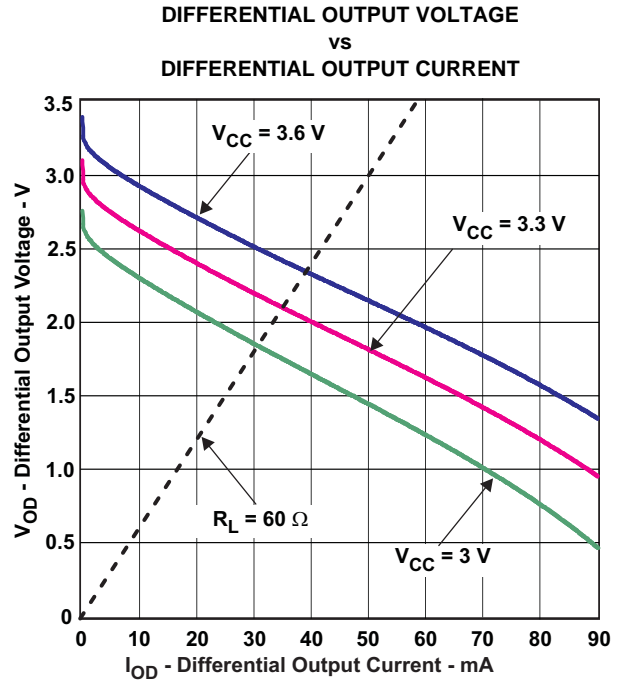

Figure 10.

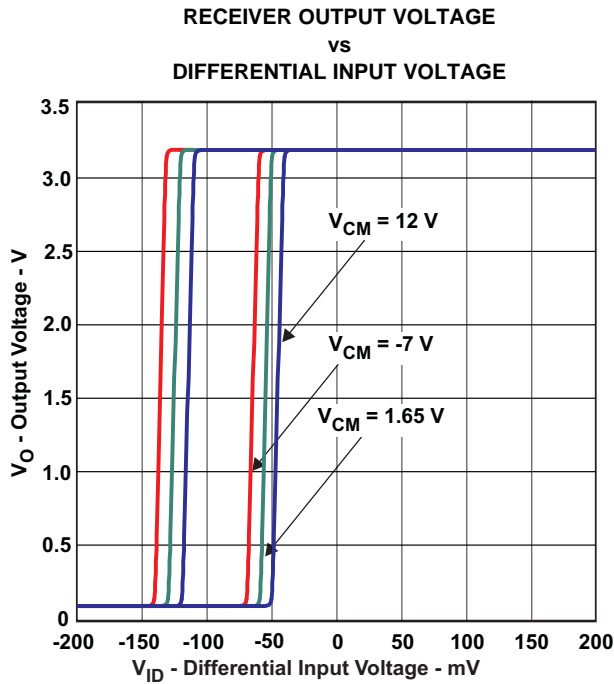

Figure 11.

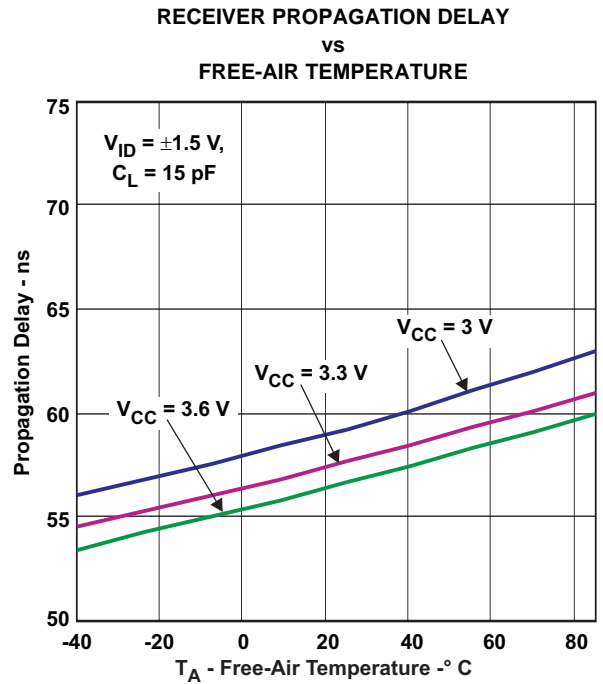

Figure 12.

TYPICAL CHARACTERISTICS (continued)

DRIVER RISE/FALL TIME

vs

FREE-AIR TEMPERATURE

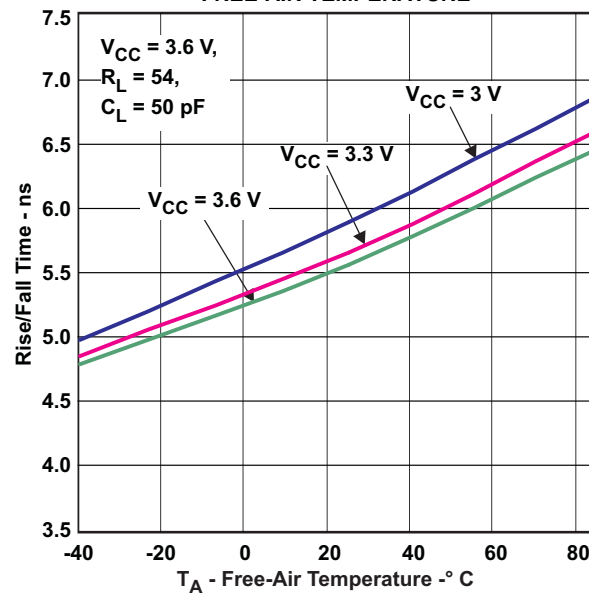

Figure 13.

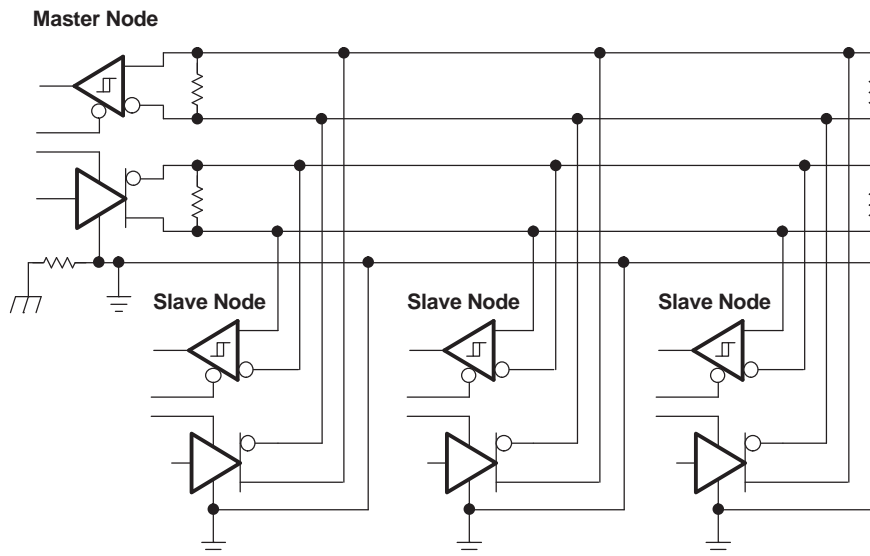

Figure 14. Example Full-Duplex Master/Slave Application Circuit

APPLICATION INFORMATION

RECEIVER FAILSAFE

The differential receiver is “failsafe” to invalid bus states caused by:

- open bus conditions such as a disconnected connector,
- shorted bus conditions such as cable damage shorting the twisted-pair together,
- or idle bus conditions that occur when no driver on the bus is actively driving.

In any of these cases, the differential receiver outputs a failsafe logic High state, so that the output of the receiver is not indeterminate.

In the HVD37, receiver failsafe is accomplished by offsetting the receiver thresholds so that the “input indeterminate” range does not include zero volts differential. In order to comply with the RS-422 and RS-485 standards, the receiver output must output a High when the differential input V_{ID} is more positive than 200 mV, and must output a Low when the V_{ID} is more negative than -200 mV. The receiver parameters which determine the failsafe performance are V_{IT+} and V_{IT-} and V_{HYS} . In the Electrical Characteristics table, V_{IT-} has a typical value of -120 mV and a minimum (most negative) value of -200 mV, so differential signals more negative than -200 mV will always cause a Low receiver output. Similarly, differential signals more positive than 200 mV will always cause a High receiver output, because the typical value of V_{IT+} is -60mV, and V_{IT+} is never more positive than -20 mV under any conditions of temperature, supply voltage, or common-mode offset.

When the differential input signal is close to zero, it will still be above the V_{IT+} threshold, and the receiver output will be High. Only when the differential input is more negative than V_{IT-} will the receiver output transition to a Low state. So, the noise immunity of the receiver inputs during a bus fault condition includes the receiver hysteresis value V_{HYS} (the separation between V_{IT+} and V_{IT-}) as well as the value of V_{IT+} .

For the HVD37, the typical noise immunity is about 120 mV, which is the negative noise level needed to exceed the V_{IT-} threshold (V_{IT-} TYP = -120 mV). In the worst case, the failsafe noise immunity is never less than 50 mV, which is set by the maximum positive threshold (V_{IT+} MAX = -20mV) plus the minimum hysteresis voltage (V_{HYS} MIN = 30 mV).

HOT-PLUGGING

These devices are designed to operate in “hot swap” or “hot pluggable” applications. Key features for hot-pluggable applications are power-up, power-down glitch free operation, default disabled input/output pins, and receiver failsafe. An internal Power-On Reset circuit keeps the driver outputs in a high-impedance state until the supply voltage has reached a level at which the device will reliably operate. This ensures that no spurious transitions (glitches) will occur on the bus pin outputs as the power supply turns on or turns off.

As shown in the device FUNCTION TABLE, the ENABLE inputs have the feature of default disable on both the driver enable and receiver enable. This ensures that the device will neither drive the bus nor report data on the R pin until the associated controller actively drives the enable pins.

LOW POWER STANDBY MODE

As is customary with RS-485 devices, the receiver output is directly enabled/disabled by \overline{RE} , and the driver outputs are directly enabled/disabled by DE.

When both the driver and receiver are disabled, (DE=LO and \overline{RE} =HI) the receiver differential comparator stage enters a standby mode for reduced power.

When either the Driver or Receiver is enabled, the receiver differential comparator stage is enabled for fast response to signal changes.

REVISION HISTORY

Changes from Original (October 2011) to Revision A	Page
• Changed the device From: Product Preview To: Production	1

PACKAGING INFORMATION

Orderable Device	Status ⁽¹⁾	Package Type	Package Drawing	Pins	Package Qty	Eco Plan ⁽²⁾	Lead/ Ball Finish	MSL Peak Temp ⁽³⁾	Samples (Requires Login)
SN65HVD37D	ACTIVE	SOIC	D	14	50	Green (RoHS & no Sb/Br)	CU NIPDAU	Level-1-260C-UNLIM	
SN65HVD37DR	ACTIVE	SOIC	D	14	2500	Green (RoHS & no Sb/Br)	CU NIPDAU	Level-1-260C-UNLIM	

⁽¹⁾ The marketing status values are defined as follows:

ACTIVE: Product device recommended for new designs.

LIFEBUY: TI has announced that the device will be discontinued, and a lifetime-buy period is in effect.

NRND: Not recommended for new designs. Device is in production to support existing customers, but TI does not recommend using this part in a new design.

PREVIEW: Device has been announced but is not in production. Samples may or may not be available.

OBsolete: TI has discontinued the production of the device.

⁽²⁾ Eco Plan - The planned eco-friendly classification: Pb-Free (RoHS), Pb-Free (RoHS Exempt), or Green (RoHS & no Sb/Br) - please check <http://www.ti.com/productcontent> for the latest availability information and additional product content details.

TBD: The Pb-Free/Green conversion plan has not been defined.

Pb-Free (RoHS): TI's terms "Lead-Free" or "Pb-Free" mean semiconductor products that are compatible with the current RoHS requirements for all 6 substances, including the requirement that lead not exceed 0.1% by weight in homogeneous materials. Where designed to be soldered at high temperatures, TI Pb-Free products are suitable for use in specified lead-free processes.

Pb-Free (RoHS Exempt): This component has a RoHS exemption for either 1) lead-based flip-chip solder bumps used between the die and package, or 2) lead-based die adhesive used between the die and leadframe. The component is otherwise considered Pb-Free (RoHS compatible) as defined above.

Green (RoHS & no Sb/Br): TI defines "Green" to mean Pb-Free (RoHS compatible), and free of Bromine (Br) and Antimony (Sb) based flame retardants (Br or Sb do not exceed 0.1% by weight in homogeneous material)

⁽³⁾ MSL, Peak Temp. -- The Moisture Sensitivity Level rating according to the JEDEC industry standard classifications, and peak solder temperature.

Important Information and Disclaimer: The information provided on this page represents TI's knowledge and belief as of the date that it is provided. TI bases its knowledge and belief on information provided by third parties, and makes no representation or warranty as to the accuracy of such information. Efforts are underway to better integrate information from third parties. TI has taken and continues to take reasonable steps to provide representative and accurate information but may not have conducted destructive testing or chemical analysis on incoming materials and chemicals. TI and TI suppliers consider certain information to be proprietary, and thus CAS numbers and other limited information may not be available for release.

In no event shall TI's liability arising out of such information exceed the total purchase price of the TI part(s) at issue in this document sold by TI to Customer on an annual basis.

TAPE AND REEL INFORMATION
REEL DIMENSIONS

TAPE DIMENSIONS

A0	Dimension designed to accommodate the component width
B0	Dimension designed to accommodate the component length
K0	Dimension designed to accommodate the component thickness
W	Overall width of the carrier tape
P1	Pitch between successive cavity centers

TAPE AND REEL INFORMATION

*All dimensions are nominal

Device	Package Type	Package Drawing	Pins	SPQ	Reel Diameter (mm)	Reel Width W1 (mm)	A0 (mm)	B0 (mm)	K0 (mm)	P1 (mm)	W (mm)	Pin1 Quadrant
SN65HVD37DR	SOIC	D	14	2500	330.0	16.4	6.5	9.0	2.1	8.0	16.0	Q1

TAPE AND REEL BOX DIMENSIONS



*All dimensions are nominal

Device	Package Type	Package Drawing	Pins	SPQ	Length (mm)	Width (mm)	Height (mm)
SN65HVD37DR	SOIC	D	14	2500	346.0	346.0	33.0

IMPORTANT NOTICE

Texas Instruments Incorporated and its subsidiaries (TI) reserve the right to make corrections, modifications, enhancements, improvements, and other changes to its products and services at any time and to discontinue any product or service without notice. Customers should obtain the latest relevant information before placing orders and should verify that such information is current and complete. All products are sold subject to TI's terms and conditions of sale supplied at the time of order acknowledgment.

TI warrants performance of its hardware products to the specifications applicable at the time of sale in accordance with TI's standard warranty. Testing and other quality control techniques are used to the extent TI deems necessary to support this warranty. Except where mandated by government requirements, testing of all parameters of each product is not necessarily performed.

TI assumes no liability for applications assistance or customer product design. Customers are responsible for their products and applications using TI components. To minimize the risks associated with customer products and applications, customers should provide adequate design and operating safeguards.

TI does not warrant or represent that any license, either express or implied, is granted under any TI patent right, copyright, mask work right, or other TI intellectual property right relating to any combination, machine, or process in which TI products or services are used. Information published by TI regarding third-party products or services does not constitute a license from TI to use such products or services or a warranty or endorsement thereof. Use of such information may require a license from a third party under the patents or other intellectual property of the third party, or a license from TI under the patents or other intellectual property of TI.

Reproduction of TI information in TI data books or data sheets is permissible only if reproduction is without alteration and is accompanied by all associated warranties, conditions, limitations, and notices. Reproduction of this information with alteration is an unfair and deceptive business practice. TI is not responsible or liable for such altered documentation. Information of third parties may be subject to additional restrictions.

Resale of TI products or services with statements different from or beyond the parameters stated by TI for that product or service voids all express and any implied warranties for the associated TI product or service and is an unfair and deceptive business practice. TI is not responsible or liable for any such statements.

TI products are not authorized for use in safety-critical applications (such as life support) where a failure of the TI product would reasonably be expected to cause severe personal injury or death, unless officers of the parties have executed an agreement specifically governing such use. Buyers represent that they have all necessary expertise in the safety and regulatory ramifications of their applications, and acknowledge and agree that they are solely responsible for all legal, regulatory and safety-related requirements concerning their products and any use of TI products in such safety-critical applications, notwithstanding any applications-related information or support that may be provided by TI. Further, Buyers must fully indemnify TI and its representatives against any damages arising out of the use of TI products in such safety-critical applications.

TI products are neither designed nor intended for use in military/aerospace applications or environments unless the TI products are specifically designated by TI as military-grade or "enhanced plastic." Only products designated by TI as military-grade meet military specifications. Buyers acknowledge and agree that any such use of TI products which TI has not designated as military-grade is solely at the Buyer's risk, and that they are solely responsible for compliance with all legal and regulatory requirements in connection with such use.

TI products are neither designed nor intended for use in automotive applications or environments unless the specific TI products are designated by TI as compliant with ISO/TS 16949 requirements. Buyers acknowledge and agree that, if they use any non-designated products in automotive applications, TI will not be responsible for any failure to meet such requirements.

Following are URLs where you can obtain information on other Texas Instruments products and application solutions:

Products

Audio	www.ti.com/audio
Amplifiers	amplifier.ti.com
Data Converters	dataconverter.ti.com
DLP® Products	www.dlp.com
DSP	dsp.ti.com
Clocks and Timers	www.ti.com/clocks
Interface	interface.ti.com
Logic	logic.ti.com
Power Mgmt	power.ti.com
Microcontrollers	microcontroller.ti.com
RFID	www.ti-rfid.com
OMAP Mobile Processors	www.ti.com/omap
Wireless Connectivity	www.ti.com/wirelessconnectivity

Applications

Automotive and Transportation	www.ti.com/automotive
Communications and Telecom	www.ti.com/communications
Computers and Peripherals	www.ti.com/computers
Consumer Electronics	www.ti.com/consumer-apps
Energy and Lighting	www.ti.com/energy
Industrial	www.ti.com/industrial
Medical	www.ti.com/medical
Security	www.ti.com/security
Space, Avionics and Defense	www.ti.com/space-avionics-defense
Video and Imaging	www.ti.com/video

TI E2E Community Home Page

e2e.ti.com

Mailing Address: Texas Instruments, Post Office Box 655303, Dallas, Texas 75265
Copyright © 2012, Texas Instruments Incorporated