

High Power Infrared Emitting Diode, 950 nm, GaAlAs/GaAs

Description

TSAL7600 is a high efficiency infrared emitting diode in GaAlAs on GaAs technology, molded in clear plastic packages.

In comparison with the standard GaAs on GaAs technology these emitters achieve more than 100 % radiant power improvement at a similar wavelength.

The forward voltages at low current and at high pulse current roughly correspond to the low values of the standard technology. Therefore these emitters are ideally suitable as high performance replacements of standard emitters.

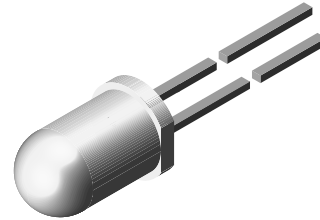

94 8389

Features

- Extra high radiant power and radiant intensity
- High reliability
- Low forward voltage
- Suitable for high pulse current operation
- Standard T-1 $\frac{3}{4}$ (\varnothing 5 mm) package
- Angle of half intensity $\varphi = \pm 30^\circ$
- Peak wavelength $\lambda_p = 940$ nm
- Good spectral matching to Si photodetectors
- Lead (Pb)-free component
- Component in accordance to RoHS 2002/95/EC and WEEE 2002/96/EC



Applications

- Infrared remote control units with high power requirements
- Free air transmission systems
- Infrared source for optical counters and card readers
- IR source for smoke detectors

Absolute Maximum Ratings

$T_{amb} = 25^\circ\text{C}$, unless otherwise specified

Parameter	Test condition	Symbol	Value	Unit
Reverse voltage		V_R	5	V
Forward current		I_F	100	mA
Peak forward current	$t_p/T = 0.5$, $t_p = 100 \mu\text{s}$	I_{FM}	200	mA
Surge forward current	$t_p = 100 \mu\text{s}$	I_{FSM}	1.5	A
Power dissipation		P_V	210	mW
Junction temperature		T_j	100	$^\circ\text{C}$
Operating temperature range		T_{amb}	- 55 to + 100	$^\circ\text{C}$
Storage temperature range		T_{stg}	- 55 to + 100	$^\circ\text{C}$
Soldering temperature	$t \leq 5$ sec, 2 mm from case	T_{sd}	260	$^\circ\text{C}$
Thermal resistance junction/ambient		R_{thJA}	350	K/W

Electrical Characteristics

$T_{amb} = 25\text{ }^{\circ}\text{C}$, unless otherwise specified

Parameter	Test condition	Symbol	Min	Typ.	Max	Unit
Forward voltage	$I_F = 100\text{ mA}$, $t_p = 20\text{ ms}$	V_F		1.35	1.6	V
	$I_F = 1\text{ A}$, $t_p = 100\text{ }\mu\text{s}$	V_F		2.6	3	V
Temp. coefficient of V_F	$I_F = 100\text{ mA}$	TK_{V_F}		-1.3		mV/K
Reverse current	$V_R = 5\text{ V}$	I_R			10	μA
Junction capacitance	$V_R = 0\text{ V}$, $f = 1\text{ MHz}$, $E = 0$	C_j		25		pF

Optical Characteristics

$T_{amb} = 25\text{ }^{\circ}\text{C}$, unless otherwise specified

Parameter	Test condition	Symbol	Min	Typ.	Max	Unit
Radiant intensity	$I_F = 100\text{ mA}$, $t_p = 20\text{ ms}$	I_e	15	25	75	mW/sr
	$I_F = 1.0\text{ A}$, $t_p = 100\text{ }\mu\text{s}$	I_e	120	200		mW/sr
Radiant power	$I_F = 100\text{ mA}$, $t_p = 20\text{ ms}$	ϕ_e		35		mW
Temp. coefficient of ϕ_e	$I_F = 20\text{ mA}$	TK_{ϕ_e}		-0.6		%/K
Angle of half intensity		ϕ		± 30		deg
Peak wavelength	$I_F = 100\text{ mA}$	λ_p		940		nm
Spectral bandwidth	$I_F = 100\text{ mA}$	$\Delta\lambda$		50		nm
Temp. coefficient of λ_p	$I_F = 100\text{ mA}$	TK_{λ_p}		0.2		nm/K
Rise time	$I_F = 100\text{ mA}$	t_r		800		ns
Fall time	$I_F = 100\text{ mA}$	t_f		800		ns
Virtual source diameter		\emptyset		1.8		mm

Typical Characteristics

$T_{amb} = 25\text{ }^{\circ}\text{C}$, unless otherwise specified

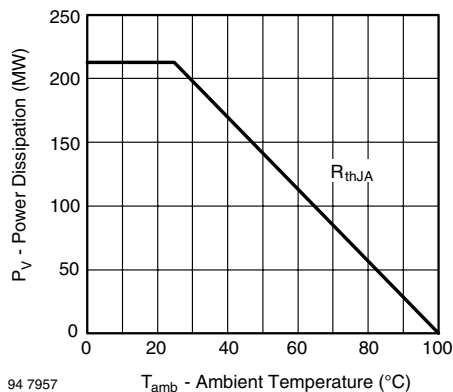

Figure 1. Power Dissipation vs. Ambient Temperature

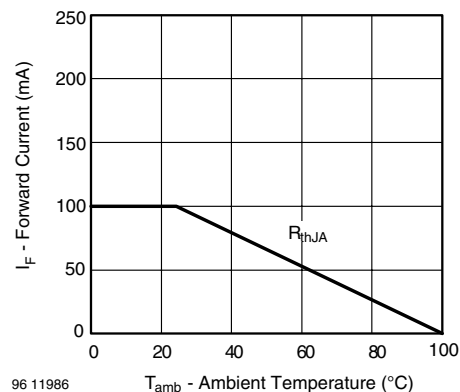

Figure 2. Forward Current vs. Ambient Temperature

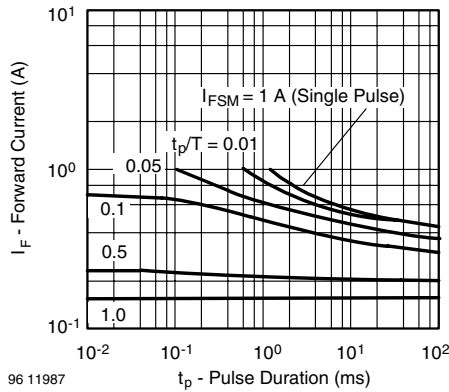

Figure 3. Pulse Forward Current vs. Pulse Duration

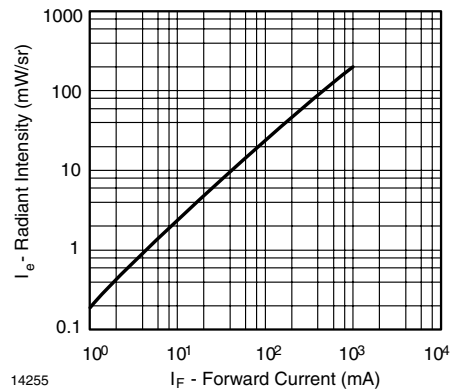

Figure 6. Radiant Intensity vs. Forward Current

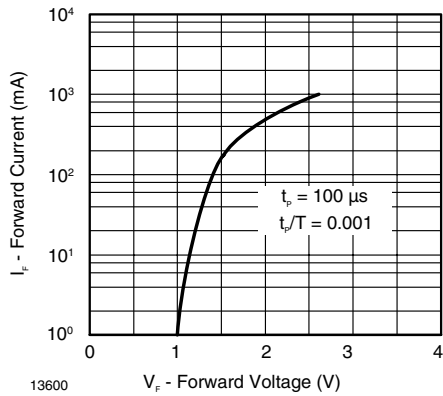

Figure 4. Forward Current vs. Forward Voltage

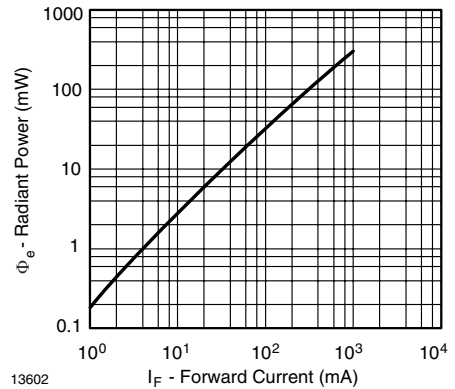

Figure 7. Radiant Power vs. Forward Current

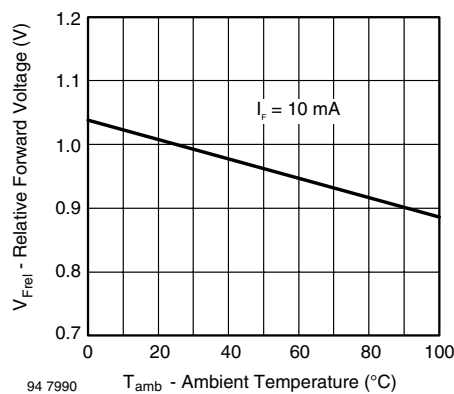

Figure 5. Relative Forward Voltage vs. Ambient Temperature

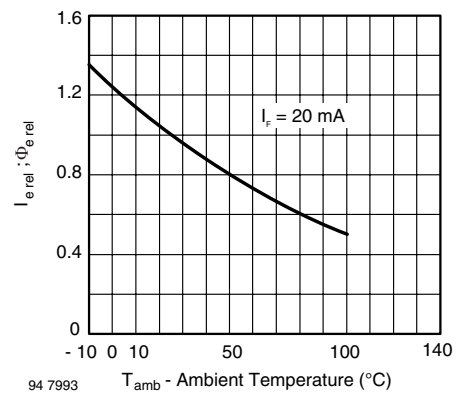

Figure 8. Rel. Radiant Intensity/Power vs. Ambient Temperature

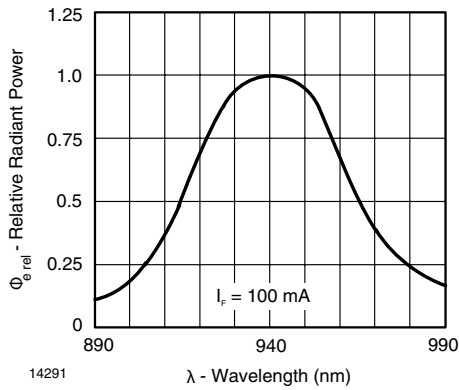

Figure 9. Relative Radiant Power vs. Wavelength

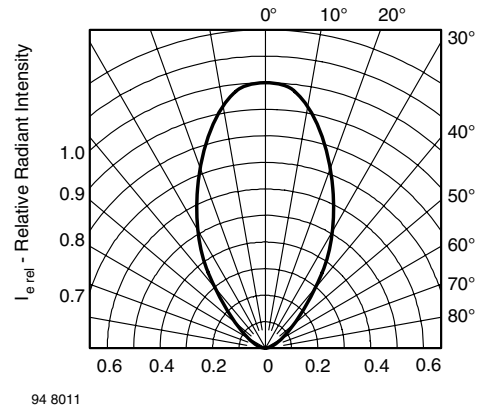
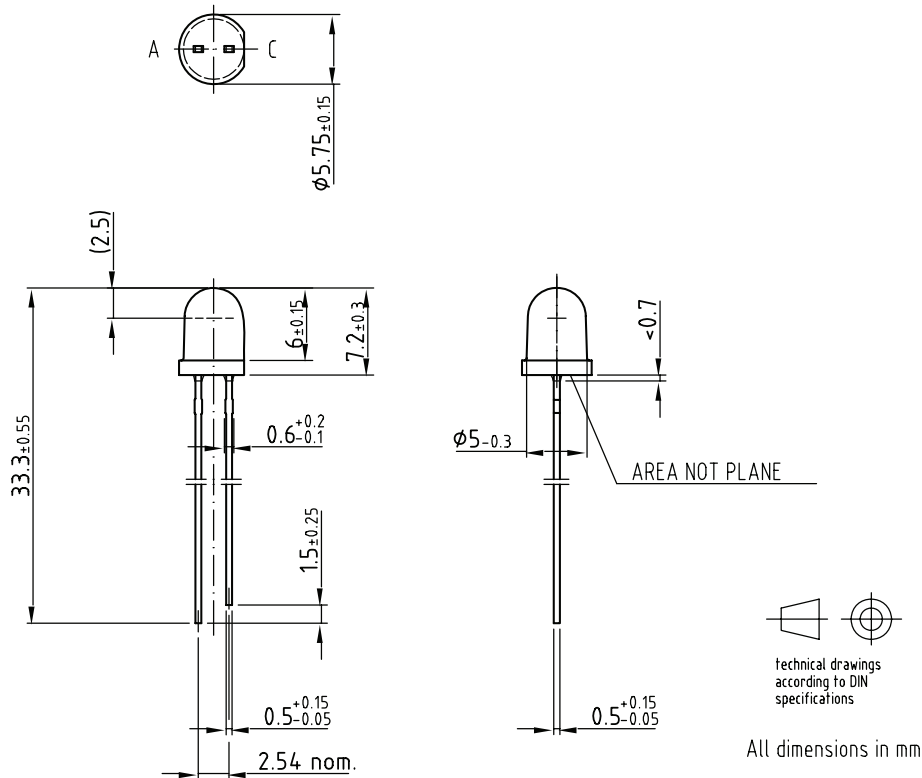

Figure 10. Relative Radiant Intensity vs. Angular Displacement

Package Dimensions in mm



Drawing refers to following types: TSAL 7600

Drawing-No. 6.544-5316.01-4
 Issue: 2; 27.09.04
 20327



Ozone Depleting Substances Policy Statement

It is the policy of Vishay Semiconductor GmbH to

1. Meet all present and future national and international statutory requirements.
2. Regularly and continuously improve the performance of our products, processes, distribution and operating systems with respect to their impact on the health and safety of our employees and the public, as well as their impact on the environment.

It is particular concern to control or eliminate releases of those substances into the atmosphere which are known as ozone depleting substances (ODSs).

The Montreal Protocol (1987) and its London Amendments (1990) intend to severely restrict the use of ODSs and forbid their use within the next ten years. Various national and international initiatives are pressing for an earlier ban on these substances.

Vishay Semiconductor GmbH has been able to use its policy of continuous improvements to eliminate the use of ODSs listed in the following documents.

1. Annex A, B and list of transitional substances of the Montreal Protocol and the London Amendments respectively
2. Class I and II ozone depleting substances in the Clean Air Act Amendments of 1990 by the Environmental Protection Agency (EPA) in the USA
3. Council Decision 88/540/EEC and 91/690/EEC Annex A, B and C (transitional substances) respectively.

Vishay Semiconductor GmbH can certify that our semiconductors are not manufactured with ozone depleting substances and do not contain such substances.

We reserve the right to make changes to improve technical design
and may do so without further notice.

Parameters can vary in different applications. All operating parameters must be validated for each customer application by the customer. Should the buyer use Vishay Semiconductors products for any unintended or unauthorized application, the buyer shall indemnify Vishay Semiconductors against all claims, costs, damages, and expenses, arising out of, directly or indirectly, any claim of personal damage, injury or death associated with such unintended or unauthorized use.

Vishay Semiconductor GmbH, P.O.B. 3535, D-74025 Heilbronn, Germany



Disclaimer

All product specifications and data are subject to change without notice.

Vishay Intertechnology, Inc., its affiliates, agents, and employees, and all persons acting on its or their behalf (collectively, "Vishay"), disclaim any and all liability for any errors, inaccuracies or incompleteness contained herein or in any other disclosure relating to any product.

Vishay disclaims any and all liability arising out of the use or application of any product described herein or of any information provided herein to the maximum extent permitted by law. The product specifications do not expand or otherwise modify Vishay's terms and conditions of purchase, including but not limited to the warranty expressed therein, which apply to these products.

No license, express or implied, by estoppel or otherwise, to any intellectual property rights is granted by this document or by any conduct of Vishay.

The products shown herein are not designed for use in medical, life-saving, or life-sustaining applications unless otherwise expressly indicated. Customers using or selling Vishay products not expressly indicated for use in such applications do so entirely at their own risk and agree to fully indemnify Vishay for any damages arising or resulting from such use or sale. Please contact authorized Vishay personnel to obtain written terms and conditions regarding products designed for such applications.

Product names and markings noted herein may be trademarks of their respective owners.