

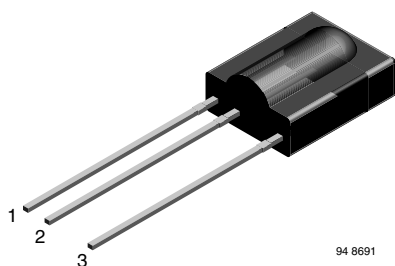

IR Receiver Modules for Remote Control Systems



FEATURES

- Very low supply current
- Photo detector and preamplifier in one package
- Internal filter for PCM frequency
- Improved shielding against EMI
- Supply voltage: 2.5 V to 5.5 V
- Improved immunity against ambient light
- Insensitive to supply voltage ripple and noise
- Compliant to RoHS Directive 2011/65/EU and in accordance to WEEE 2002/96/EC



Note

** Please see document "Vishay Material Category Policy": www.vishay.com/doc?99902

MECHANICAL DATA

Pinning:

1 = GND, 2 = V_S, 3 = OUT

DESCRIPTION

The TSOP1#.. series are miniaturized receivers for infrared remote control systems. A PIN diode and a preamplifier are assembled on a lead frame, the epoxy package acts as an IR filter.

The demodulated output signal can be directly decoded by a microprocessor. The TSOP11.. is compatible with all common IR remote control data formats. The TSOP13.. is optimized to better suppress spurious pulses from energy saving fluorescent lamps but will also suppress some data signals.

This component has not been qualified according to automotive specifications.

| PARTS TABLE | | |
|-------------------|--|---|
| CARRIER FREQUENCY | SHORT BURST AND HIGH DATA RATES (AGC1) | NOISY ENVIRONMENTS AND SHORT BURTS (AGC3) |
| 30 kHz | TSOP1130 | TSOP1330 |
| 33 kHz | TSOP1133 | TSOP1333 |
| 36 kHz | TSOP1136 | TSOP1336 |
| 36.7 kHz | TSOP1137 | TSOP1337 |
| 38 kHz | TSOP1138 | TSOP1338 |
| 40 kHz | TSOP1140 | TSOP1340 |
| 56 kHz | TSOP1156 | TSOP1356 |

BLOCK DIAGRAM

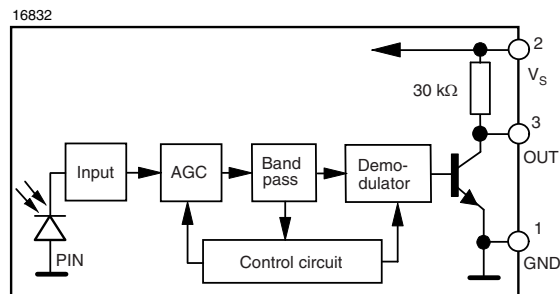

APPLICATION CIRCUIT

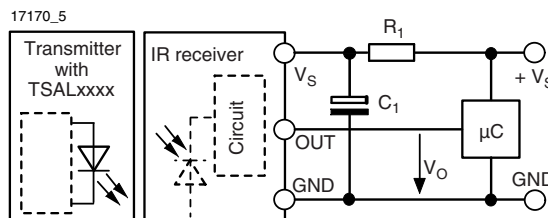

R₁ and C₁ are recommended for protection against EOS. Components should be in the range of 33 Ω < R₁ < 1 kΩ, C₁ > 0.1 μF.



| ABSOLUTE MAXIMUM RATINGS | | | | |
|-----------------------------|-------------------------------|-----------|--------------------------|------|
| PARAMETER | TEST CONDITION | SYMBOL | VALUE | UNIT |
| Supply voltage (pin 2) | | V_S | - 0.3 to + 6 | V |
| Supply current (pin 2) | | I_S | 3 | mA |
| Output voltage (pin 3) | | V_O | - 0.3 to ($V_S + 0.3$) | V |
| Output current (pin 3) | | I_O | 5 | mA |
| Junction temperature | | T_j | 100 | °C |
| Storage temperature range | | T_{stg} | - 25 to + 85 | °C |
| Operating temperature range | | T_{amb} | - 25 to + 85 | °C |
| Power consumption | $T_{amb} \leq 85$ °C | P_{tot} | 10 | mW |
| Soldering temperature | $t \leq 10$ s, 1 mm from case | T_{sd} | 260 | °C |

Note

- Stresses beyond those listed under “Absolute Maximum Ratings” may cause permanent damage to the device. This is a stress rating only and functional operation of the device at these or any other conditions beyond those indicated in the operational sections of this specification is not implied. Exposure to absolute maximum rating conditions for extended periods may affect the device reliability.

| ELECTRICAL AND OPTICAL CHARACTERISTICS ($T_{amb} = 25$ °C, unless otherwise specified) | | | | | | |
|---|--|--------------|------|----------|------|-------------------|
| PARAMETER | TEST CONDITION | SYMBOL | MIN. | TYP. | MAX. | UNIT |
| Supply voltage | | V_S | 2.5 | | 5.5 | V |
| Supply current (pin 2) | $E_v = 0, V_S = 3.3$ V | I_{SD} | 0.27 | 0.35 | 0.45 | mA |
| | $E_v = 40$ klx, sunlight | I_{SH} | | 0.45 | | mA |
| Transmission distance | $E_v = 0$, test signal see fig. 1, IR diode TSAL6200, $I_F = 250$ mA | d | | 45 | | m |
| Output voltage low (pin 3) | $I_{OSL} = 0.5$ mA, $E_e = 0.7$ mW/m ² , test signal see fig. 1 | V_{OSL} | | | 100 | mV |
| Minimum irradiance | Pulse width tolerance: $t_{pi} - 5/f_0 < t_{po} < t_{pi} + 6/f_0$, test signal see fig. 1 | E_e min. | | 0.15 | 0.35 | mW/m ² |
| Maximum irradiance | $t_{pi} - 5/f_0 < t_{po} < t_{pi} + 6/f_0$, test signal see fig. 1 | E_e max. | 30 | | | W/m ² |
| Directivity | Angle of half transmission distance | $\phi_{1/2}$ | | ± 45 | | deg |

TYPICAL CHARACTERISTICS ($T_{amb} = 25$ °C, unless otherwise specified)

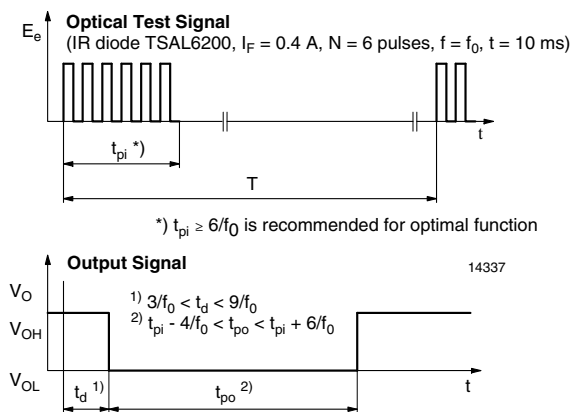

Fig. 1 - Output Active Low

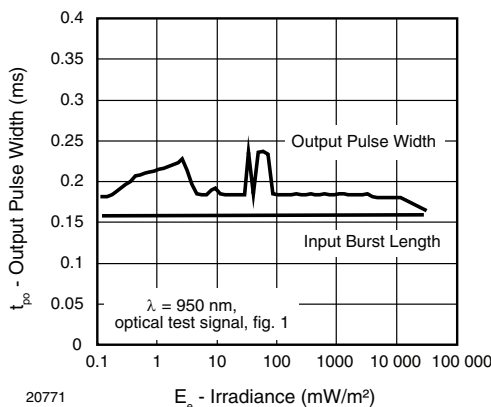

Fig. 2 - Pulse Length and Sensitivity in Dark Ambient

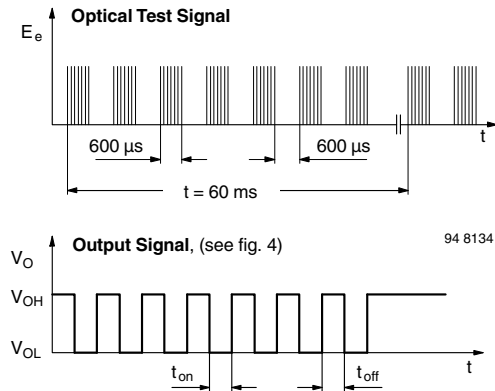

Fig. 3 - Output Function

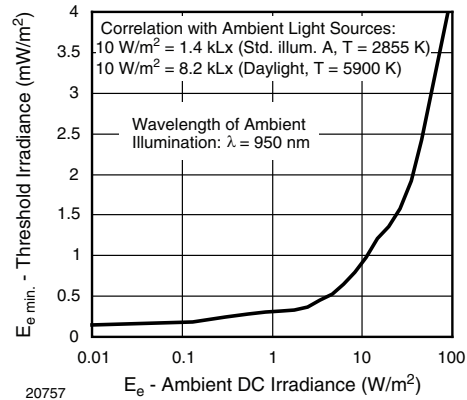

Fig. 6 - Sensitivity in Bright Ambient

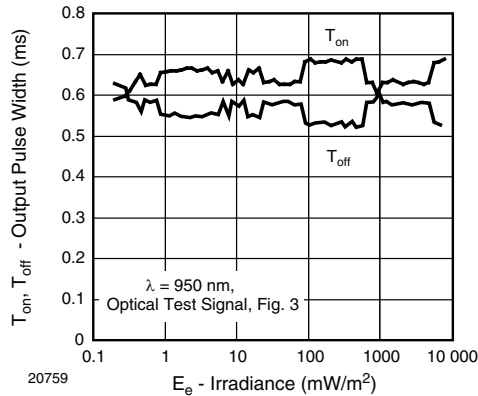

Fig. 4 - Output Pulse Diagram

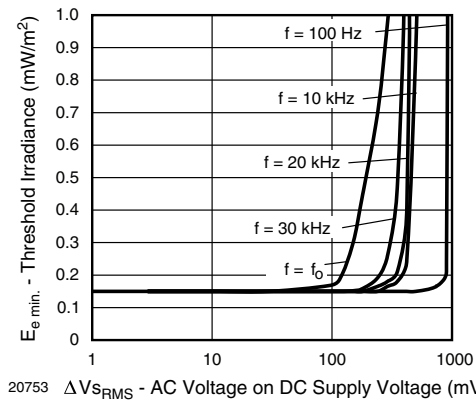

Fig. 7 - Sensitivity vs. Supply Voltage Disturbances

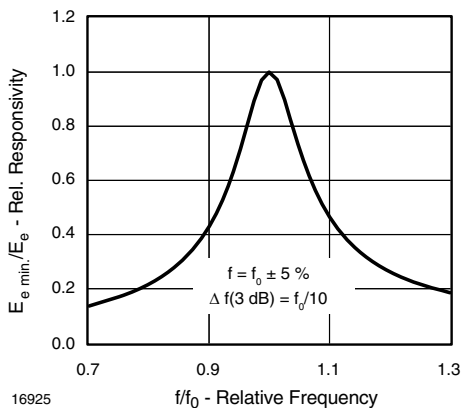

Fig. 5 - Frequency Dependence of Responsivity

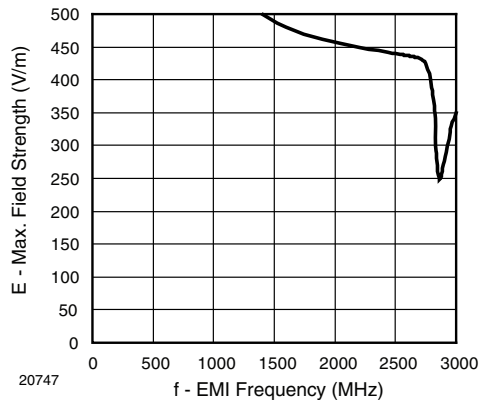

Fig. 8 - Sensitivity vs. Electric Field Disturbances

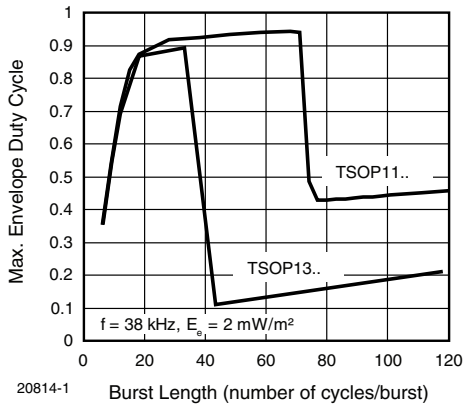

Fig. 9 - Max. Envelope Duty Cycle vs. Burst Length

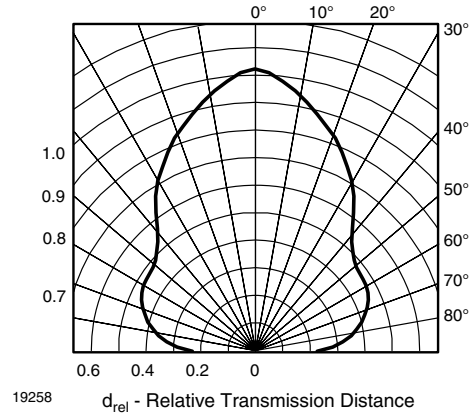

Fig. 12 - Horizontal Directivity

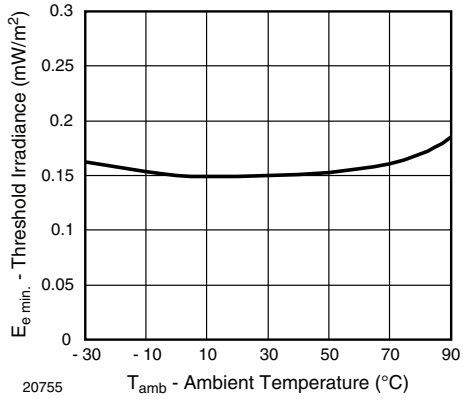

Fig. 10 - Sensitivity vs. Ambient Temperature

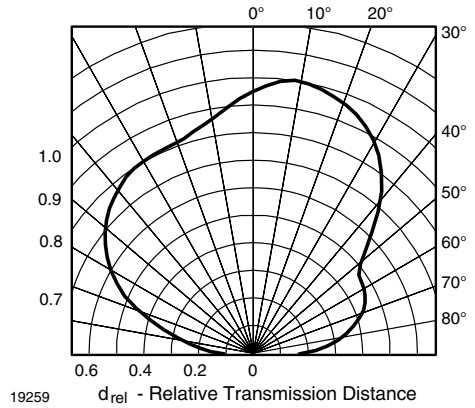

Fig. 13 - Vertical Directivity

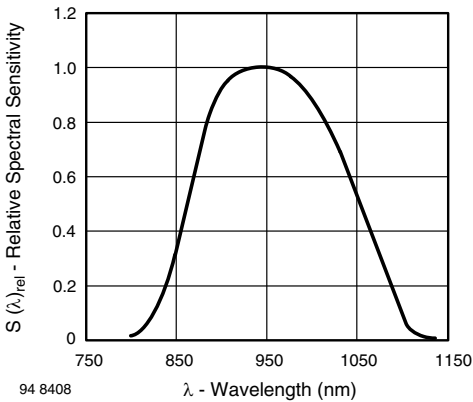

Fig. 11 - Relative Spectral Sensitivity vs. Wavelength

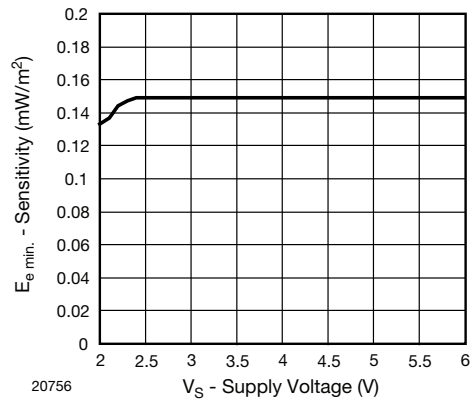

Fig. 14 - Sensitivity vs. Supply Voltage



SUITABLE DATA FORMAT

The TSOP11.., TSOP13.. series is designed to suppress spurious output pulses due to noise or disturbance signals. Data and disturbance signals can be distinguished by the devices according to carrier frequency, burst length and envelope duty cycle. The data signal should be close to the band-pass center frequency (e.g. 38 kHz) and fulfill the conditions in the table below.

When a data signal is applied to the TSOP1#.. in the presence of a disturbance signal, the sensitivity of the receiver is reduced to insure that no spurious pulses are present at the output. Some examples of disturbance signals which are suppressed are:

- DC light (e.g. from tungsten bulb or sunlight)
- Continuous signals at any frequency
- Modulated noise from fluorescent lamps with electronic ballasts

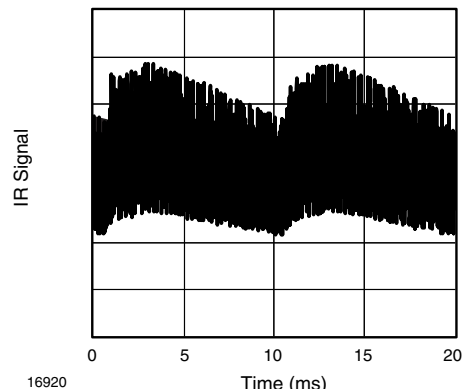

Fig. 15 - IR Signal from Fluorescent Lamp with Low Modulation

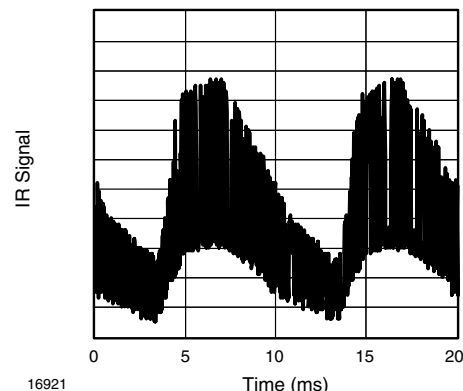

Fig. 16 - IR Signal from Fluorescent Lamp with High Modulation

| | TSOP11.. | TSOP13.. |
|--|--|--|
| Minimum burst length | 6 cycles/burst | 6 cycles/burst |
| After each burst of length a minimum gap time is required of | 6 to 70 cycles ≥ 10 cycles | 6 to 35 cycles ≥ 10 cycles |
| For bursts greater than a minimum gap time in the data stream is needed of | 70 cycles > 1.2 x burst length | 35 cycles > 6 x burst length |
| Maximum number of continuous short bursts/second | 2000 | 2000 |
| Recommended for NEC code | yes | yes |
| Recommended for RC5/RC6 code | yes | yes |
| Recommended for Sony code | yes | no |
| Recommended for RCMM code | yes | yes |
| Recommended for r-step code | yes | yes |
| Recommended for XMP code | yes | yes |
| Suppression of interference from fluorescent lamps | Common disturbance signals are suppressed (example: signal pattern of fig. 15) | Even critical disturbance signals are suppressed (examples: signal pattern of fig. 15 and fig. 16) |

Note

- For data formats with long bursts (more than 10 carrier cycles) please see the datasheet for TSOP12.



PACKAGE DIMENSIONS in millimeters

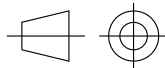
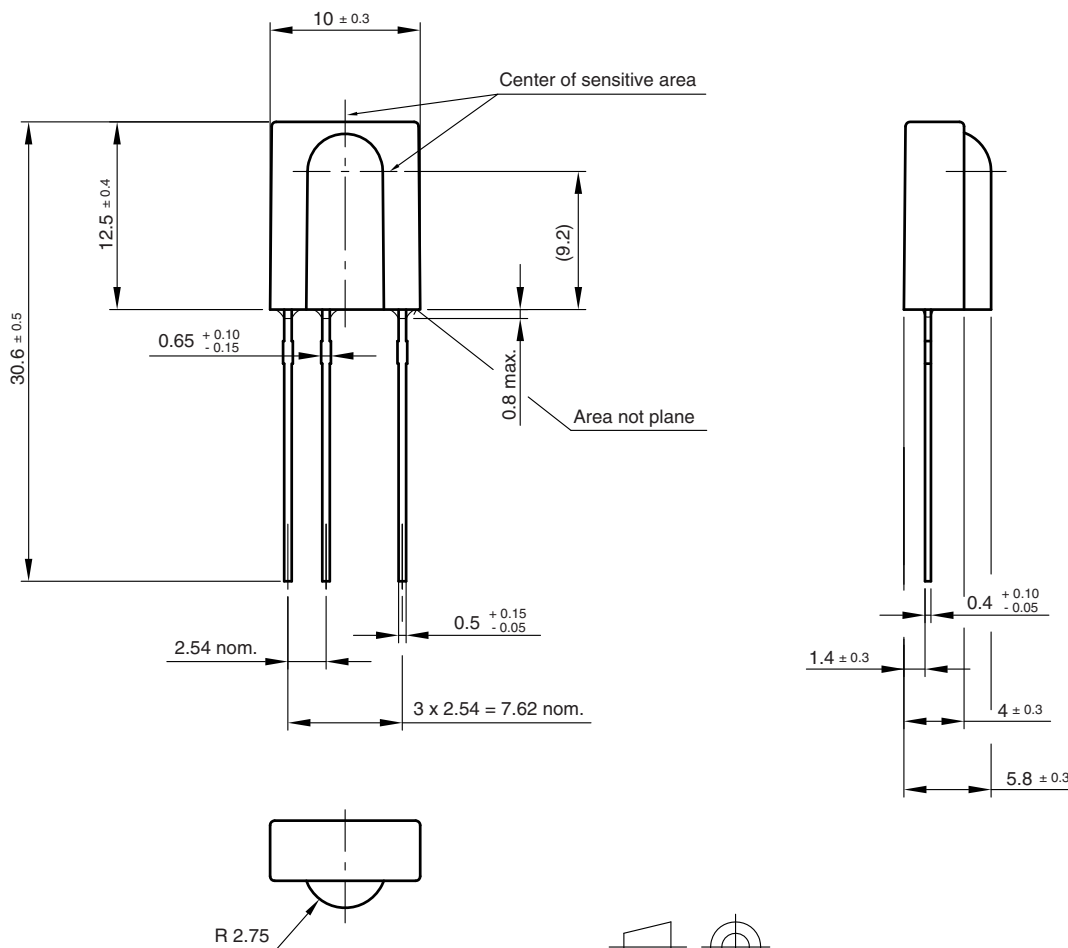

technical drawings according to DIN specifications

Drawing-No.: 6.550-5095.01-4

Issue: 20; 15.03.10

96 12116



Disclaimer

ALL PRODUCT, PRODUCT SPECIFICATIONS AND DATA ARE SUBJECT TO CHANGE WITHOUT NOTICE TO IMPROVE RELIABILITY, FUNCTION OR DESIGN OR OTHERWISE.

Vishay Intertechnology, Inc., its affiliates, agents, and employees, and all persons acting on its or their behalf (collectively, "Vishay"), disclaim any and all liability for any errors, inaccuracies or incompleteness contained in any datasheet or in any other disclosure relating to any product.

Vishay makes no warranty, representation or guarantee regarding the suitability of the products for any particular purpose or the continuing production of any product. To the maximum extent permitted by applicable law, Vishay disclaims (i) any and all liability arising out of the application or use of any product, (ii) any and all liability, including without limitation special, consequential or incidental damages, and (iii) any and all implied warranties, including warranties of fitness for particular purpose, non-infringement and merchantability.

Statements regarding the suitability of products for certain types of applications are based on Vishay's knowledge of typical requirements that are often placed on Vishay products in generic applications. Such statements are not binding statements about the suitability of products for a particular application. It is the customer's responsibility to validate that a particular product with the properties described in the product specification is suitable for use in a particular application. Parameters provided in datasheets and/or specifications may vary in different applications and performance may vary over time. All operating parameters, including typical parameters, must be validated for each customer application by the customer's technical experts. Product specifications do not expand or otherwise modify Vishay's terms and conditions of purchase, including but not limited to the warranty expressed therein.

Except as expressly indicated in writing, Vishay products are not designed for use in medical, life-saving, or life-sustaining applications or for any other application in which the failure of the Vishay product could result in personal injury or death. Customers using or selling Vishay products not expressly indicated for use in such applications do so at their own risk and agree to fully indemnify and hold Vishay and its distributors harmless from and against any and all claims, liabilities, expenses and damages arising or resulting in connection with such use or sale, including attorneys fees, even if such claim alleges that Vishay or its distributor was negligent regarding the design or manufacture of the part. Please contact authorized Vishay personnel to obtain written terms and conditions regarding products designed for such applications.

No license, express or implied, by estoppel or otherwise, to any intellectual property rights is granted by this document or by any conduct of Vishay. Product names and markings noted herein may be trademarks of their respective owners.

Material Category Policy

Vishay Intertechnology, Inc. hereby certifies that all its products that are identified as RoHS-Compliant fulfill the definitions and restrictions defined under Directive 2011/65/EU of The European Parliament and of the Council of June 8, 2011 on the restriction of the use of certain hazardous substances in electrical and electronic equipment (EEE) - recast, unless otherwise specified as non-compliant.

Please note that some Vishay documentation may still make reference to RoHS Directive 2002/95/EC. We confirm that all the products identified as being compliant to Directive 2002/95/EC conform to Directive 2011/65/EU.