

# High Voltage, High Gain BIMOSFET™ Monolithic Bipolar MOS Transistor

**IXBH 10N170**  
**IXBT 10N170**

$V_{CES} = 1700 \text{ V}$   
 $I_{C25} = 20 \text{ A}$   
 $V_{CE(sat)} = 3.8 \text{ V}$

## Preliminary Data Sheet

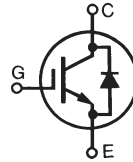

Symbol	Test Conditions	Maximum Ratings
$V_{CES}$	$T_J = 25^\circ\text{C}$ to $150^\circ\text{C}$	1700 V
$V_{CGR}$	$T_J = 25^\circ\text{C}$ to $150^\circ\text{C}$ ; $R_{GE} = 1 \text{ M}\Omega$	1700 V
$V_{GES}$	Continuous	$\pm 20$ V
$V_{GEM}$	Transient	$\pm 30$ V
$I_{C25}$	$T_C = 25^\circ\text{C}$	20 A
$I_{C90}$	$T_C = 90^\circ\text{C}$	10 A
$I_{CM}$	$T_C = 25^\circ\text{C}$ , 1 ms	40 A
<b>SSOA (RBSOA)</b>	$V_{GE} = 15 \text{ V}$ , $T_{VJ} = 125^\circ\text{C}$ , $R_G = 33 \Omega$ Clamped inductive load	$I_{CM} = 20$ A $V_{CES} = 1350$ V
$P_C$	$T_C = 25^\circ\text{C}$	140 W
$T_J$		$-55 \dots +150$ $^\circ\text{C}$
$T_{JM}$		150 $^\circ\text{C}$
$T_{stg}$		$-55 \dots +150$ $^\circ\text{C}$
	Maximum Lead temperature for soldering 1.6 mm (0.062 in.) from case for 10 s	300 $^\circ\text{C}$
	Maximum Tab temperature for soldering SMD devices for 10 s	260 $^\circ\text{C}$
$M_d$	Mounting torque (M3) (TO-247)	1.13/10Nm/lb.in.
<b>Weight</b>	TO-247 AD	6 g
	TO-268	4 g

Symbol	Test Conditions	Characteristic Values ( $T_J = 25^\circ\text{C}$ , unless otherwise specified)		
		min.	typ.	max.
$BV_{CES}$	$I_C = 250 \mu\text{A}$ , $V_{GE} = 0 \text{ V}$ Temperature Coefficient	1700	0.10	V %/K
$V_{GE(th)}$	$I_C = 250 \mu\text{A}$ , $V_{CE} = V_{GE}$ Temperature Coefficient	3.0	- 0.24	V %/K
$I_{CES}$	$V_{CE} = 0.8 V_{CES}$ , $T_J = 25^\circ\text{C}$ $V_{GE} = 0 \text{ V}$ , $T_J = 125^\circ\text{C}$			10 $\mu\text{A}$ 100 $\mu\text{A}$
$I_{GES}$	$V_{CE} = 0 \text{ V}$ , $V_{GE} = \pm 20 \text{ V}$			$\pm 100$ nA
$V_{CE(sat)}$	$I_C = I_{C90}$ , $V_{GE} = 15 \text{ V}$ $T_J = 125^\circ\text{C}$	3.4	4.1	3.8 V V

### TO-268 (IXBT)

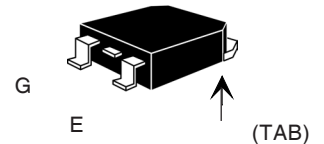

### TO-247 AD (IXBH)

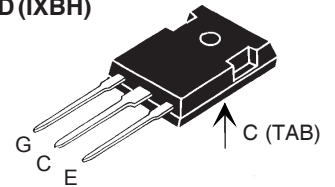

G = Gate, C = Collector,  
E = Emitter, TAB = Collector

### Features

- High Blocking Voltage
- JEDEC TO-268 surface and JEDEC TO-247 AD
- Low conduction losses
- High current handling capability
- MOS Gate turn-on - drive simplicity
- Molding epoxies meet UL 94 V-0 flammability classification

### Applications

- AC motor speed control
- Uninterruptible power supplies (UPS)
- Switched-mode and resonant-mode power supplies
- Capacitor discharge circuits

### Advantages

- High power density
- Suitable for surface mounting
- Easy to mount with 1 screw, (isolated mounting screw hole)

Symbol	Test Conditions	Characteristic Values		
		$(T_J = 25^\circ\text{C}, \text{ unless otherwise specified})$		
		min.	typ.	max.
$g_{fs}$	$I_C = I_{C90}; V_{CE} = 10\text{ V},$ Pulse test, $t \leq 300\ \mu\text{s}, \text{ duty cycle} \leq 2\%$	4.0	6.5	S
$C_{ies}$	$V_{CE} = 25\text{ V}, V_{GE} = 0\text{ V}, f = 1\text{ MHz}$		700	pF
$C_{oes}$			40	pF
$C_{res}$			12	pF
$Q_g$	$I_C = I_{C90}; V_{GE} = 15\text{ V}, V_{CE} = 0.5 V_{CES}$		30	nC
$Q_{ge}$			6	nC
$Q_{gc}$			10	nC
$t_{d(on)}$	<b>Inductive load, <math>T_J = 25^\circ\text{C}</math></b> $I_C = I_{C90}; V_{GE} = 15\text{ V}$ $V_{CE} = 0.8 V_{CES}; R_G = R_{off} = 56\ \Omega$		35	ns
$t_{ri}$			28	ns
$t_{d(off)}$			500	ns
$t_{fi}$			1000	ns
$E_{off}$			6	mJ
$t_{d(on)}$	<b>Inductive load, <math>T_J = 125^\circ\text{C}</math></b> $I_C = I_{C90}; V_{GE} = 15\text{ V}$ $V_{CE} = 0.8 V_{CES}; R_G = R_{off} = 56\ \Omega$		35	ns
$t_{ri}$			28	ns
$E_{on}$			0.7	mJ
$t_{d(off)}$			600	ns
$t_{fi}$			1200	ns
$E_{off}$		8	mJ	
$R_{thJC}$				0.89 K/W
$R_{thCK}$	(TO-247)	0.25		K/W

Symbol	Test Conditions	Characteristic Values		
		$(T_J = 25^\circ\text{C}, \text{ unless otherwise specified})$		
		min.	typ.	max.
$V_F$	$I_F = I_{C90}; V_{GE} = 0\text{ V}, \text{ Pulse test},$ $t \leq 300\ \mu\text{s}, \text{ duty cycle } d \leq 2\%$			3.0 V
$I_{RM}$	$I_F = I_{C90}; V_{GE} = 0\text{ V}, -di_F/dt = 50\text{ A}/\mu\text{s}$		10	A
$t_{rr}$		$V_R = 100\text{ V}$		360

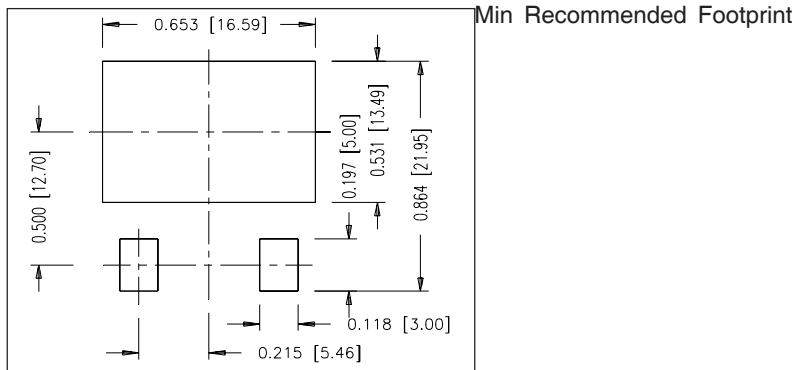

### TO-247 AD Outline

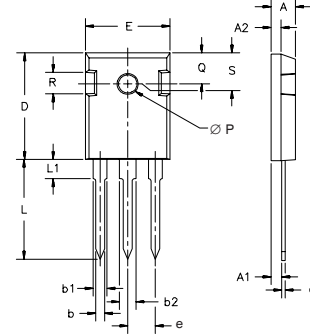

Dim.	Millimeter		Inches	
	Min.	Max.	Min.	Max.
A	4.7	5.3	.185	.209
A <sub>1</sub>	2.2	2.54	.087	.102
A <sub>2</sub>	2.2	2.6	.059	.098
b	1.0	1.4	.040	.055
b <sub>1</sub>	1.65	2.13	.065	.084
b <sub>2</sub>	2.87	3.12	.113	.123
C	.4	.8	.016	.031
D	20.80	21.46	.819	.845
E	15.75	16.26	.610	.640
e	5.20	5.72	0.205	0.225
L	19.81	20.32	.780	.800
L <sub>1</sub>		4.50		.177
∅P	3.55	3.65	.140	.144
Q	5.89	6.40	0.232	0.252
R	4.32	5.49	.170	.216
S	6.15	BSC	242	BSC

### TO-268 Outline

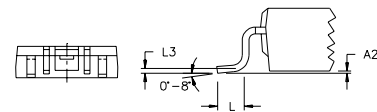
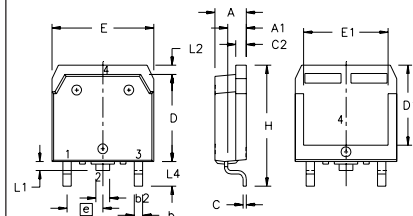

SYM	INCHES		MILLIMETERS	
	MIN	MAX	MIN	MAX
A	.193	.201	4.90	5.10
A <sub>1</sub>	.106	.114	2.70	2.90
A <sub>2</sub>	.001	.010	0.02	0.25
b	.045	.057	1.15	1.45
b <sub>2</sub>	.075	.083	1.90	2.10
C	.016	.026	0.40	0.65
C <sub>2</sub>	.057	.063	1.45	1.60
D	.543	.551	13.80	14.00
D <sub>1</sub>	.488	.500	12.40	12.70
E	.624	.632	15.85	16.05
E <sub>1</sub>	.524	.535	13.30	13.60
e		.215 BSC		5.45 BSC
H	.736	.752	18.70	19.10
L	.094	.106	2.40	2.70
L <sub>1</sub>	.047	.055	1.20	1.40
L <sub>2</sub>	.039	.045	1.00	1.15
L <sub>3</sub>		.010 BSC		0.25 BSC
L <sub>4</sub>	.150	.161	3.80	4.10

IXYS reserves the right to change limits, test conditions, and dimensions.

IXYS MOSFETs and IGBTs are covered by one or more of the following U.S. patents:

4,835,592 4,881,106 5,017,508 5,049,961 5,187,117 5,486,715 6,306,728B1 6,259,123B1 6,306,728B1  
4,850,072 4,931,844 5,034,796 5,063,307 5,237,481 5,381,025 6,404,065B1 6,162,665 6,534,343

**Fig. 1. Output Characteristics**  
@ 25 Deg. C

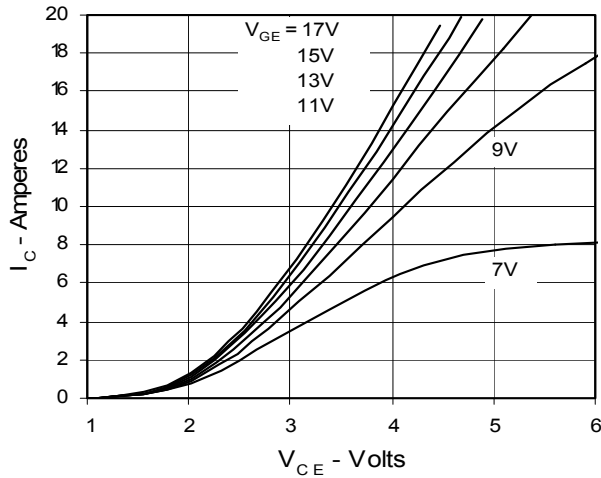

**Fig. 2. Extended Output Characteristics**  
@ 25 deg. C

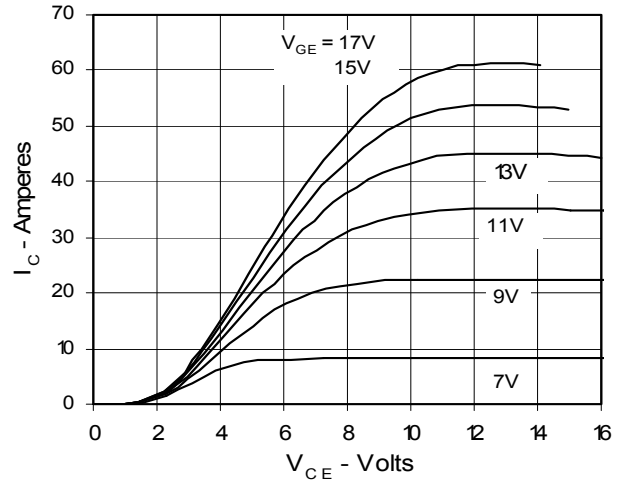

**Fig. 3. Output Characteristics**  
@ 125 Deg. C

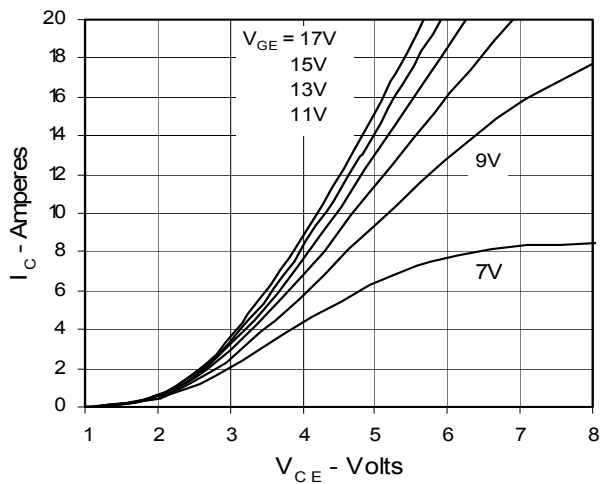

**Fig. 4. Temperature Dependence of  $V_{CE(sat)}$**

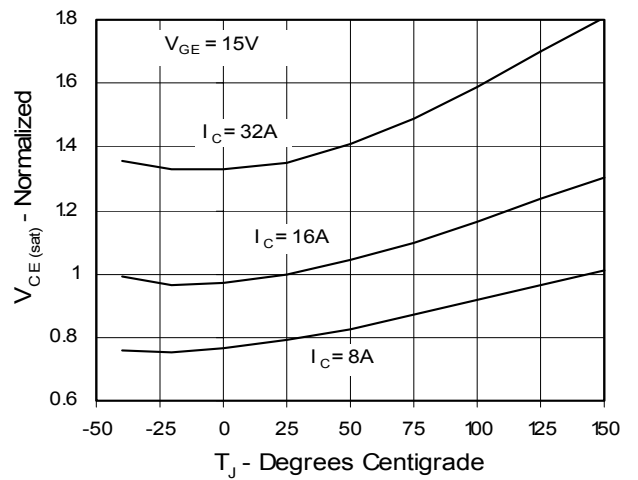

**Fig. 5. Collector-to-Emitter Voltage vs. Gate-to-Emitter voltage**

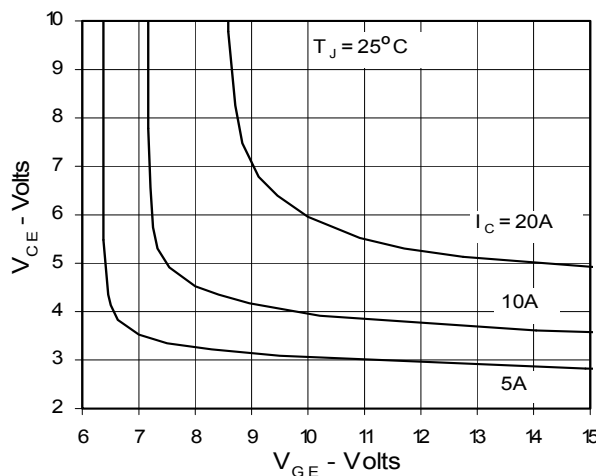

**Fig. 6. Input Admittance**

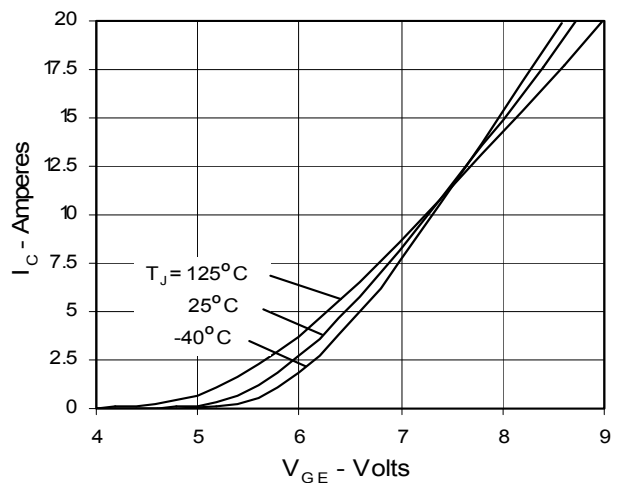

Fig. 7. Transconductance

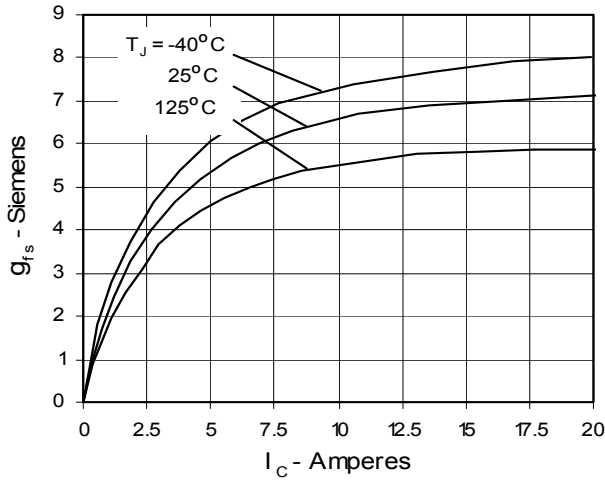

Fig. 8. Forward Voltage Drop of Intrinsic Diode

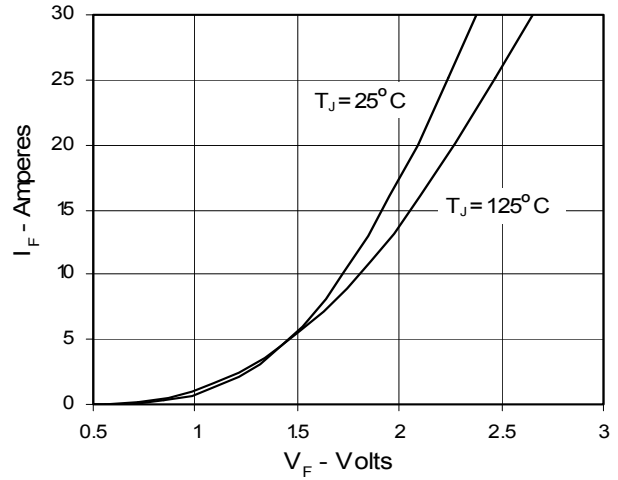

Fig. 9. Dependence of  $E_{off}$  on  $R_G$

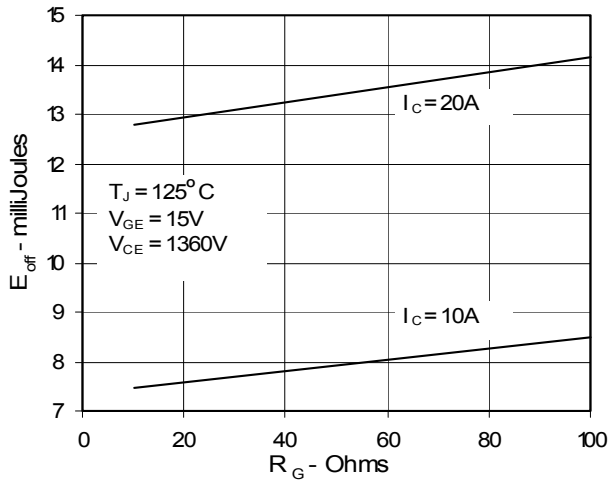

Fig. 10. Dependence of  $E_{off}$  on  $I_C$

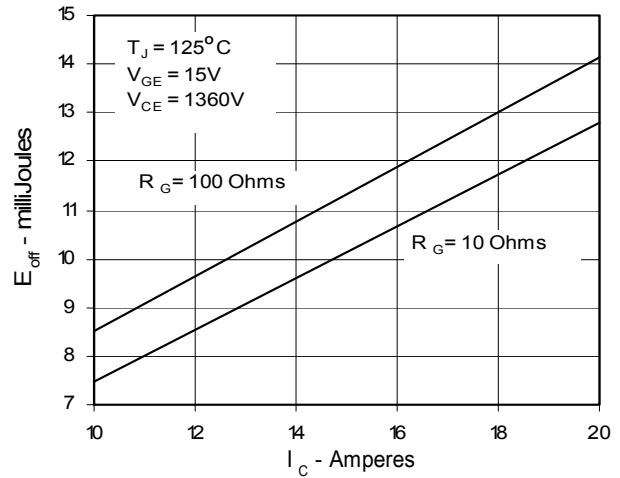

Fig. 11. Dependence of  $E_{off}$  on Temperature

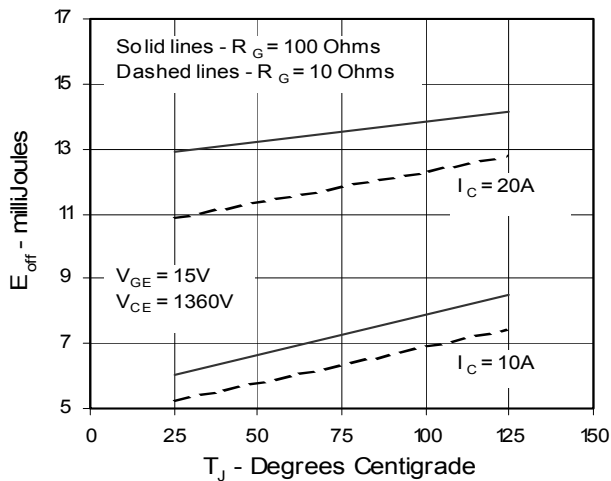
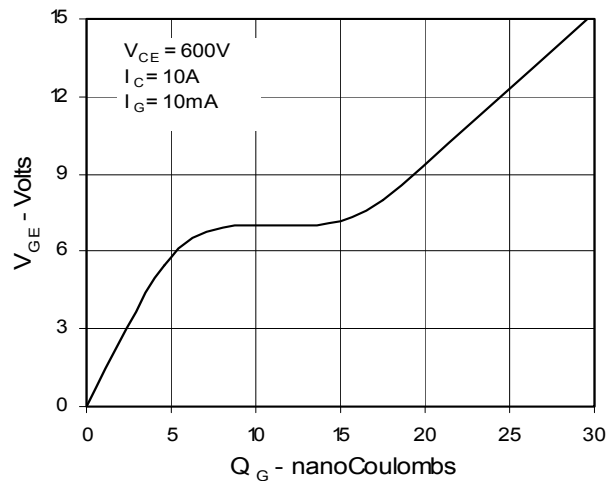

Fig. 12. Gate Charge



IXYS reserves the right to change limits, test conditions, and dimensions.

IXYS MOSFETs and IGBTs are covered by one or more of the following U.S. patents:

4,835,592 4,881,106 5,017,508 5,049,961 5,187,117 5,486,715 6,306,728B1 6,259,123B1 6,306,728B1  
4,850,072 4,931,844 5,034,796 5,063,307 5,237,481 5,381,025 6,404,065B1 6,162,665 6,534,343

Fig. 12. Capacitance

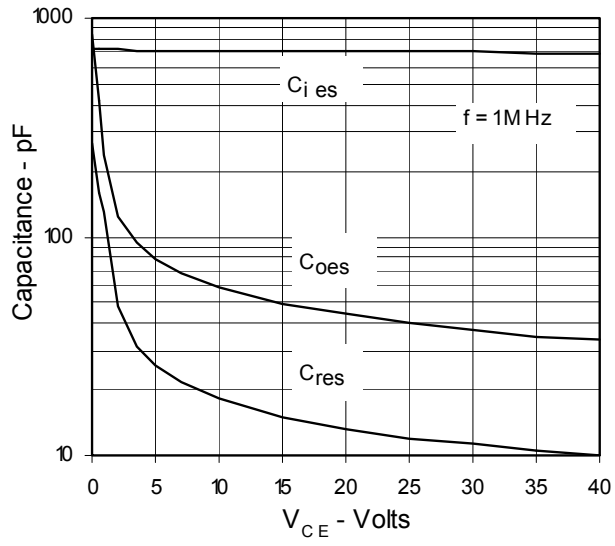

Fig. 13. Maximum Transient Thermal Resistance

