

## SILICON NPN POWER DARLINGTON TRANSISTOR

- STMicroelectronics PREFERRED SALESTYPE
- NPN DARLINGTON
- HIGH CURRENT CAPABILITY
- INTEGRATED ANTIPARALLEL COLLECTOR-EMITTER DIODE

### DESCRIPTION

The device is a silicon Epitaxial-Base NPN power transistor in monolithic Darlington configuration mounted in Jedec TO-220 plastic package. It is intended for use in low and medium frequency power applications.

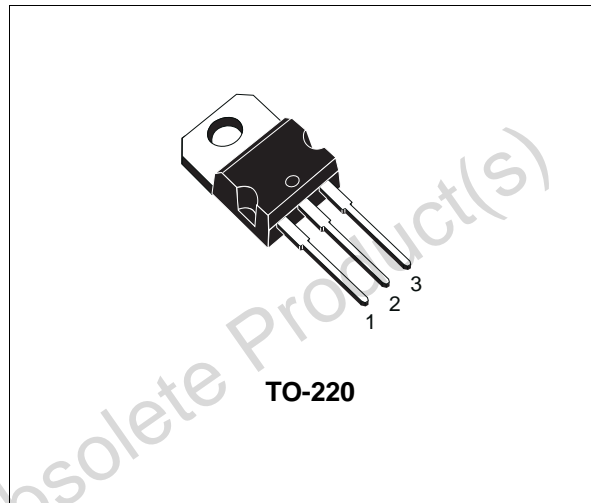

### INTERNAL SCHEMATIC DIAGRAM

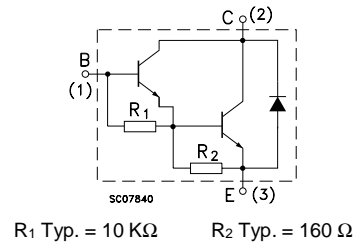

### ABSOLUTE MAXIMUM RATINGS

Symbol	Parameter	Value	Unit
V <sub>CB0</sub>	Collector-Base Voltage (I <sub>B</sub> = 0)	80	V
V <sub>CEV</sub>	Collector-Emitter Voltage (V <sub>BE</sub> = -1.5V)	80	V
V <sub>CER</sub>	Collector-Emitter Voltage (R <sub>BE</sub> ≤ 100Ω)	80	V
V <sub>CEO</sub>	Collector-Emitter Voltage (I <sub>B</sub> = 0)	80	V
V <sub>EBO</sub>	Emitter-Base Voltage (I <sub>C</sub> = 0)	5	V
I <sub>C</sub>	Collector Current	10	A
I <sub>CM</sub>	Collector Peak Current	15	A
I <sub>B</sub>	Base Current	0.25	A
P <sub>tot</sub>	Total Dissipation at T <sub>c</sub> ≤ 25 °C	65	W
T <sub>stg</sub>	Storage Temperature	-65 to 150	°C
T <sub>j</sub>	Max. Operating Junction Temperature	150	°C

## THERMAL DATA

R <sub>thj-case</sub>	Thermal Resistance Junction-case	Max	1.92	°C/W
-----------------------	----------------------------------	-----	------	------

ELECTRICAL CHARACTERISTICS (T<sub>case</sub> = 25 °C unless otherwise specified)

Symbol	Parameter	Test Conditions	Min.	Typ.	Max.	Unit
I <sub>CEV</sub>	Collector Cut-off Current (V <sub>BE</sub> = -1.5V)	V <sub>CE</sub> = 80 V V <sub>CE</sub> = 80 V      T <sub>c</sub> = 125 °C			0.3 3	mA mA
I <sub>CEO</sub>	Collector Cut-off Current (I <sub>B</sub> = 0)	V <sub>CE</sub> = 80 V			1	mA
I <sub>EBO</sub>	Emitter Cut-off Current (I <sub>C</sub> = 0)	V <sub>EB</sub> = 5 V			5	mA
V <sub>CEO(sus)*</sub>	Collector-Emitter Sustaining Voltage (I <sub>B</sub> = 0)	I <sub>C</sub> = 200 mA	80			V
V <sub>CER(sus)*</sub>	Collector-Emitter Sustaining Voltage	I <sub>C</sub> = 200 mA      R <sub>BE</sub> = 100 Ω	80			V
V <sub>CEV(sus)*</sub>	Collector-Emitter Sustaining Voltage	I <sub>C</sub> = 200 mA      V <sub>BE</sub> = -1.5V	80			V
V <sub>CE(sat)*</sub>	Collector-Emitter Saturation Voltage	I <sub>C</sub> = 5 A      I <sub>B</sub> = 10 mA I <sub>C</sub> = 10 A      I <sub>B</sub> = 100 mA			2 3	V V
V <sub>BE*</sub>	Base-Emitter Voltage	I <sub>C</sub> = 5 A      V <sub>CE</sub> = 3 V I <sub>C</sub> = 10 A      V <sub>CE</sub> = 3 V			2.8 4.5	V V
h <sub>FE*</sub>	DC Current Gain	I <sub>C</sub> = 5 A      V <sub>CE</sub> = 3 V I <sub>C</sub> = 10 A      V <sub>CE</sub> = 3 V	1000 100		20000	
h <sub>fe</sub>	Small Signal Current Gain	I <sub>C</sub> = 1 A      V <sub>CE</sub> = 10 V      f = 1MHz I <sub>C</sub> = 1 A      V <sub>CE</sub> = 10 V      f = 1KHz	20 1000			
V <sub>F*</sub>	Parallel-diode Forward Voltage	I <sub>F</sub> = 10 A			4	V
C <sub>CBO</sub>	Collector Base Capacitance	I <sub>E</sub> = 0      V <sub>CB</sub> = 10 V      f = 1MHz			200	pF
I <sub>s/b**</sub>	Second Breakdown Collector Current	V <sub>CE</sub> = 25 V	2.6			A
E <sub>s/b</sub>	Second Breakdown Energy	L = 12 mH      R <sub>BE</sub> = 100 Ω V <sub>BE</sub> = -1.5 V      I <sub>C</sub> = 4.5 A	120			mJ

\* Pulsed: Pulse duration = 300 μs, duty cycle 1.5 %

\*\* Pulsed: Pulse duration = 100ms non repetitive pulse.

Safe Operating Area

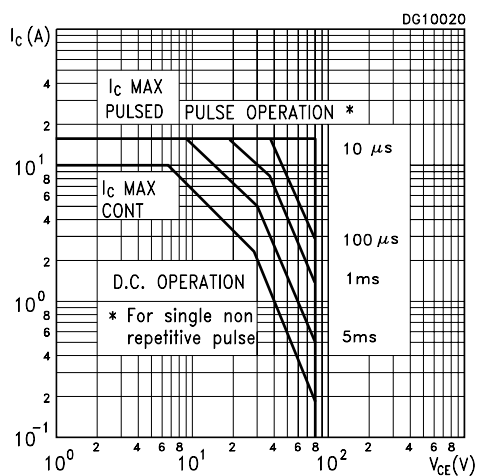

DC Current Gain

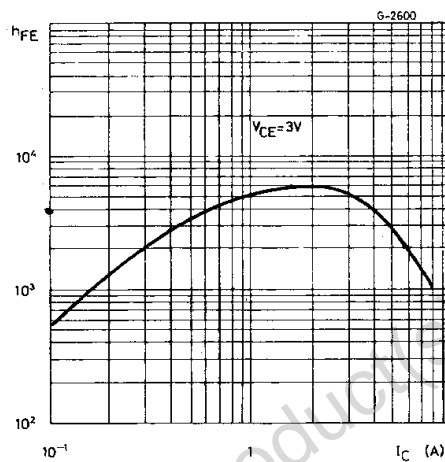

Collector Emitter Saturation Voltage

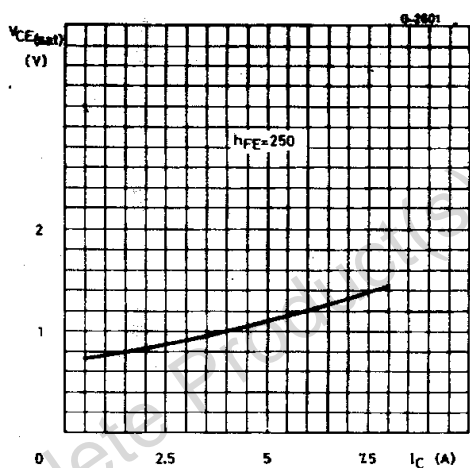

DC Transconductance

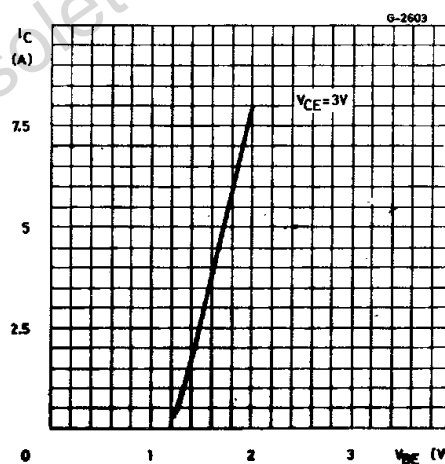

Collector Emitter Saturation Voltage

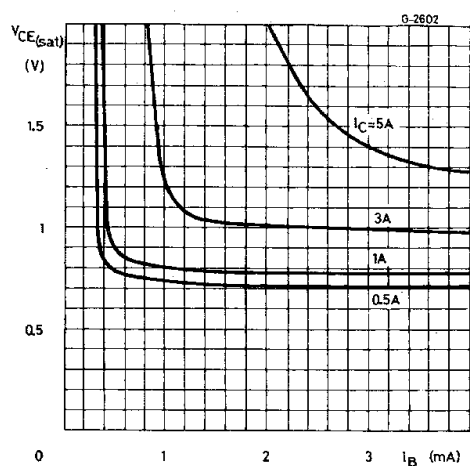

Saturated Switching Characteristics

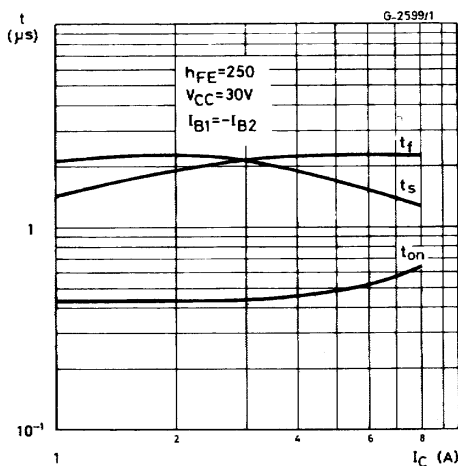

**TO-220 MECHANICAL DATA**

DIM.	mm			inch		
	MIN.	TYP.	MAX.	MIN.	TYP.	MAX.
A	4.40		4.60	0.173		0.181
C	1.23		1.32	0.048		0.051
D	2.40		2.72	0.094		0.107
D1		1.27			0.050	
E	0.49		0.70	0.019		0.027
F	0.61		0.88	0.024		0.034
F1	1.14		1.70	0.044		0.067
F2	1.14		1.70	0.044		0.067
G	4.95		5.15	0.194		0.203
G1	2.4		2.7	0.094		0.106
H2	10.0		10.40	0.393		0.409
L2		16.4			0.645	
L4	13.0		14.0	0.511		0.551
L5	2.65		2.95	0.104		0.116
L6	15.25		15.75	0.600		0.620
L7	6.2		6.6	0.244		0.260
L9	3.5		3.93	0.137		0.154
DIA.	3.75		3.85	0.147		0.151

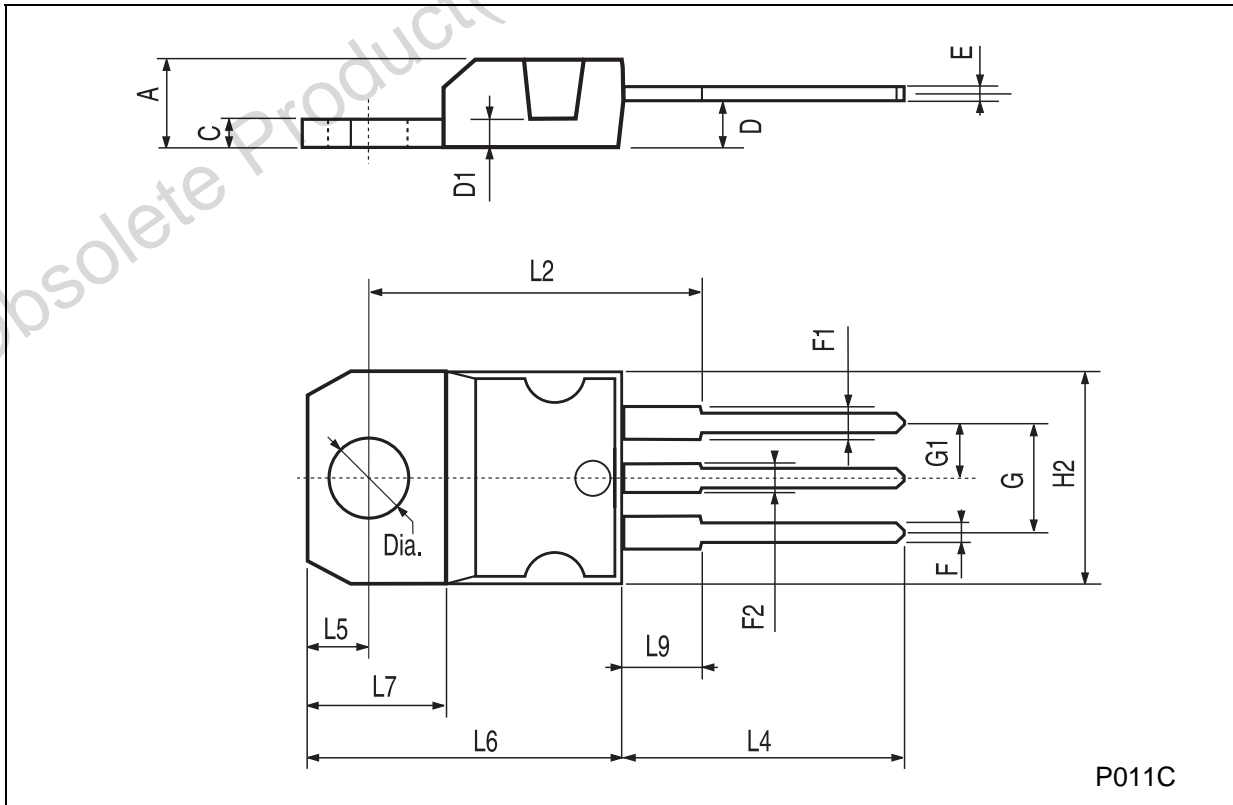

P011C

Obsolete Product(s) - Obsolete Product(s)

Information furnished is believed to be accurate and reliable. However, STMicroelectronics assumes no responsibility for the consequences of use of such information nor for any infringement of patents or other rights of third parties which may result from its use. No license is granted by implication or otherwise under any patent or patent rights of STMicroelectronics. Specification mentioned in this publication are subject to change without notice. This publication supersedes and replaces all information previously supplied. STMicroelectronics products are not authorized for use as critical components in life support devices or systems without express written approval of STMicroelectronics.

The ST logo is a trademark of STMicroelectronics

© 2000 STMicroelectronics – Printed in Italy – All Rights Reserved

STMicroelectronics GROUP OF COMPANIES

Australia - Brazil - China - Finland - France - Germany - Hong Kong - India - Italy - Japan - Malaysia - Malta - Morocco -  
Singapore - Spain - Sweden - Switzerland - United Kingdom - U.S.A.

<http://www.st.com>