

## Rail-to-rail 1.8 V high-speed comparator

### Features

- Propagation delay: 38 ns
- Low current consumption: 73  $\mu$ A
- Rail-to-rail inputs
- Push-pull outputs
- Supply operation from 1.8 to 5 V
- Wide temperature range: -40° C to +125° C
- High ESD tolerance: 5 kV HBM / 300 V MM
- Latch-up immunity: 200 mA
- SMD packages

### Applications

- Telecom
- Instrumentation
- Signal conditioning
- High-speed sampling systems
- Portable communication systems

### Description

The TS3021 single comparator features high-speed response time with rail-to-rail inputs. With a supply voltage specified from 2 to 5 V, this comparator can operate over a wide temperature range: -40° C to +125° C.

The TS3021 comparator offers micropower consumption as low as a few tens of microamperes thus providing an excellent ratio of power consumption current versus response time.

The TS3021 includes push-pull outputs and is available in small packages (SOT23-5 and SC70-5).

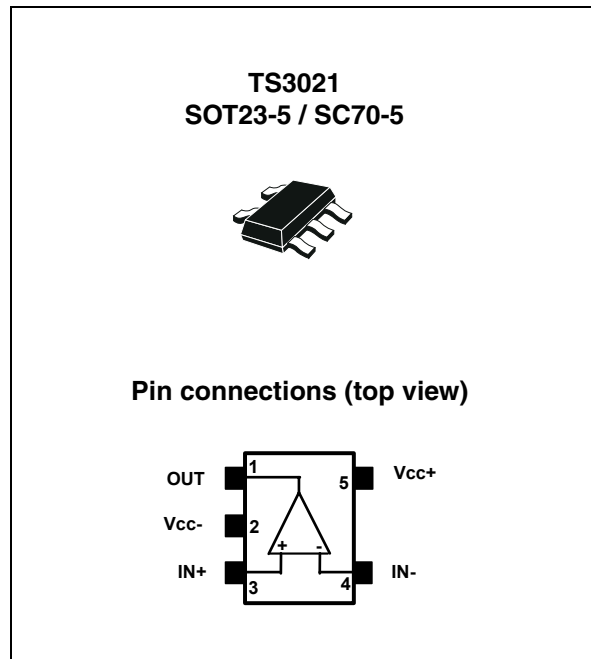

# 1 Absolute maximum ratings and operating conditions

**Table 1. Absolute maximum ratings**

Symbol	Parameter	Value	Unit
$V_{CC}$	Supply voltage <sup>(1)</sup>	5.5	V
$V_{ID}$	Differential input voltage <sup>(2)</sup>	±5	V
$V_{IN}$	Input voltage range	$V_{DD}-0.3$ to $V_{CC}+0.3$	V
$R_{thja}$	Thermal resistance junction to ambient <sup>(3)</sup>		°C/W
	SC70-5 SOT23-5	205 250	
$R_{thjc}$	Thermal resistance junction to case <sup>(3)</sup>		°C/W
	SC70-5 SOT23-5	172 81	
$T_{stg}$	Storage temperature	-65 to +150	°C
$T_j$	Junction temperature	150	°C
$T_{LEAD}$	Lead temperature (soldering 10 seconds)	260	°C
ESD	Human body model (HBM) <sup>(4)</sup>	5000	V
	Machine model (MM) <sup>(5)</sup>	300	
	Charged device model (CDM) <sup>(6)</sup>	1500	
	Latch-up immunity	200	mA

1. All voltage values, except differential voltage, are referenced to  $V_{DD}$ .
2. The magnitude of input and output voltages must never exceed the supply rail ±0.3 V.
3. Short-circuits can cause excessive heating. These values are typical.
4. Human body model: a 100 pF capacitor is charged to the specified voltage, then discharged through a 1.5 kΩ resistor between two pins of the device. This is done for all couples of connected pin combinations while the other pins are floating.
5. Machine model: a 200 pF capacitor is charged to the specified voltage, then discharged directly between two pins of the device with no external series resistor (internal resistor < 5 Ω). This is done for all couples of connected pin combinations while the other pins are floating.
6. Charged device model: all pins and the package are charged together to the specified voltage and then discharged directly to the ground through only one pin. This is done for all pins.

**Table 2. Operating conditions**

Symbol	Parameter	Value	Unit
$T_{oper}$	Operating temperature range	-40 to +125	°C
$V_{CC}$	Supply voltage		V
	$0^{\circ}C < T_{amb} < +125^{\circ}C$ $-40^{\circ}C < T_{amb} < +125^{\circ}C$	1.8 to 5 2 to 5	
$V_{icm}$	Common mode input voltage range	$V_{DD}-0.2$ to $V_{CC}+0.2$ $V_{DD}$ to $V_{CC}$	V

## 2 Electrical characteristics

**Table 3.**  $V_{CC} = +2\text{ V}$ ,  $T_{amb} = +25^\circ\text{ C}$ , full  $V_{icm}$  range (unless otherwise specified)<sup>(1)</sup>

Symbol	Parameter	Test conditions	Min.	Typ.	Max.	Unit
$V_{IO}$	Input offset voltage	$-40^\circ\text{ C} < T_{amb} < +125^\circ\text{ C}$	-	0.5	6 7	mV
$\Delta V_{IO}$	Input offset voltage drift	$-40^\circ\text{ C} < T_{amb} < +125^\circ\text{ C}$	-	3	20	$\mu\text{V}/^\circ\text{C}$
$I_{IO}$	Input offset current <sup>(2)</sup>	$-40^\circ\text{ C} < T_{amb} < +125^\circ\text{ C}$	-	1	20 100	nA
$I_{IB}$	Input bias current <sup>(2)</sup>	$-40^\circ\text{ C} < T_{amb} < +125^\circ\text{ C}$	-	86	160 300	nA
$I_{CC}$	Supply current	No load, output high, $V_{icm} = 0\text{ V}$ $-40^\circ\text{ C} < T_{amb} < +125^\circ\text{ C}$	-	73	90 115	$\mu\text{A}$
		No load, output low, $V_{icm} = 0\text{ V}$ $-40^\circ\text{ C} < T_{amb} < +125^\circ\text{ C}$	-	84	105 125	
$I_{SC}$	Short-circuit current	Source Sink	-	9 10	-	mA
$V_{OH}$	Output voltage high	$I_{source} = 1\text{ mA}$ $-40^\circ\text{ C} < T_{amb} < +125^\circ\text{ C}$	1.88 1.80	1.92	-	V
$V_{OL}$	Output voltage low	$I_{sink} = 1\text{ mA}$ $-40^\circ\text{ C} < T_{amb} < +125^\circ\text{ C}$	-	60	100 150	mV
CMRR	Common mode rejection ratio	$0 < V_{icm} < 2\text{ V}$	-	67	-	dB
SVR	Supply voltage rejection	$\Delta V_{CC} = 2\text{ to }5\text{ V}$	58	73	-	dB
$TP_{LH}$	Propagation delay <sup>(3)</sup> Low to High output level	$V_{icm} = 0\text{ V}$ , $f = 10\text{ kHz}$ , $C_L = 50\text{ pF}$ , Overdrive = 100 mV Overdrive = 20 mV	-	38	60	ns
				48	75	
$TP_{HL}$	Propagation delay <sup>(4)</sup> High to Low output level	$V_{icm} = 0\text{ V}$ , $f = 10\text{ kHz}$ , $C_L = 50\text{ pF}$ , Overdrive = 100 mV Overdrive = 20 mV	-	40	60	ns
				49	75	
$T_F$	Fall time	$f = 10\text{ kHz}$ , $C_L = 50\text{ pF}$ , $R_L = 10\text{ k}\Omega$ , Overdrive = 100 mV	-	8	-	ns
$T_R$	Rise time	$f = 10\text{ kHz}$ , $C_L = 50\text{ pF}$ , $R_L = 10\text{ k}\Omega$ , Overdrive = 100 mV	-	9	-	ns

1. All values over the temperature range are guaranteed through correlation and simulation. No production test is performed at the temperature range limits.
2. Maximum values include unavoidable inaccuracies of the industrial tests.
3. Response time is measured 10%/90% of final output value with following conditions: Inverting input voltage (IN-) =  $V_{ICM}$  and Non-inverting input voltage (IN+) moving from  $V_{ICM} - 100\text{ mV}$  to  $V_{ICM} + \text{overdrive}$ .
4. Response time is measured 10%/90% of final output value with following conditions: Inverting input voltage (IN-) =  $V_{ICM}$  and Non-inverting input voltage (IN+) moving from  $V_{ICM} + 100\text{ mV}$  to  $V_{ICM} - \text{overdrive}$ .

Table 4.  $V_{CC} = +3.3\text{ V}$ ,  $T_{amb} = +25^\circ\text{ C}$ , full  $V_{icm}$  range (unless otherwise specified)<sup>(1)</sup>

Symbol	Parameter	Test conditions	Min.	Typ.	Max.	Unit
$V_{IO}$	Input offset voltage	$-40^\circ\text{ C} < T_{amb} < +125^\circ\text{ C}$	-	0.2	6 7	mV
$\Delta V_{IO}$	Input offset voltage drift	$-40^\circ\text{ C} < T_{amb} < +125^\circ\text{ C}$	-	3	20	$\mu\text{V}/^\circ\text{C}$
$I_{IO}$	Input offset current <sup>(2)</sup>	$-40^\circ\text{ C} < T_{amb} < +125^\circ\text{ C}$	-	1	20 100	nA
$I_{IB}$	Input bias current <sup>(2)</sup>	$-40^\circ\text{ C} < T_{amb} < +125^\circ\text{ C}$	-	86	160 300	nA
$I_{CC}$	Supply current	No load, output high, $V_{icm} = 0\text{ V}$ $-40^\circ\text{ C} < T_{amb} < +125^\circ\text{ C}$  No load, output low, $V_{icm} = 0\text{ V}$ $-40^\circ\text{ C} < T_{amb} < +125^\circ\text{ C}$	-	75 86	90 120 110 125	$\mu\text{A}$
$I_{SC}$	Short circuit current	Source Sink	-	26 24	-	mA
$V_{OH}$	Output voltage high	$I_{source} = 1\text{ mA}$ $-40^\circ\text{ C} < T_{amb} < +125^\circ\text{ C}$	3.20 3.10	3.25	-	V
$V_{OL}$	Output voltage low	$I_{sink} = 1\text{ mA}$ $-40^\circ\text{ C} < T_{amb} < +125^\circ\text{ C}$	-	40	80 150	mV
CMRR	Common mode rejection ratio	$0 < V_{icm} < 3.3\text{ V}$	-	75	-	dB
SVR	Supply voltage rejection	$\Delta V_{CC} = 2\text{ to }5\text{ V}$	58	73	-	dB
$TP_{LH}$	Propagation delay <sup>(3)</sup> Low to High output level	$V_{icm} = 0\text{ V}$ , $f = 10\text{ kHz}$ , $C_L = 50\text{ pF}$ , Overdrive = 100 mV Overdrive = 20 mV	-	39 50	65 85	ns
$TP_{HL}$	Propagation delay <sup>(4)</sup> High to Low output level	$V_{icm} = 0\text{ V}$ , $f = 10\text{ kHz}$ , $C_L = 50\text{ pF}$ , Overdrive = 100 mV Overdrive = 20 mV	-	41 51	65 80	ns
$T_F$	Fall time	$f = 10\text{ kHz}$ , $C_L = 50\text{ pF}$ , $R_L = 10\text{ k}\Omega$ , Overdrive = 100 mV	-	5	-	ns
$T_R$	Rise time	$f = 10\text{ kHz}$ , $C_L = 50\text{ pF}$ , $R_L = 10\text{ k}\Omega$ , Overdrive = 100 mV	-	7	-	ns

1. All values over the temperature range are guaranteed through correlation and simulation. No production test is performed at the temperature range limits.
2. Maximum values include unavoidable inaccuracies of the industrial tests.
3. Response time is measured 10%/90% of final output value with following conditions: Inverting input voltage (IN-) =  $V_{ICM}$  and Non-inverting input voltage (IN+) moving from  $V_{ICM} - 100\text{ mV}$  to  $V_{ICM} + \text{overdrive}$ .
4. Response time is measured 10%/90% of final output value with following conditions: Inverting input voltage (IN-) =  $V_{ICM}$  and Non-inverting input voltage (IN+) moving from  $V_{ICM} + 100\text{ mV}$  to  $V_{ICM} - \text{overdrive}$ .

Table 5.  $V_{CC} = +5\text{ V}$ ,  $T_{amb} = +25^\circ\text{ C}$ , full  $V_{icm}$  range (unless otherwise specified)<sup>(1)</sup>

Symbol	Parameter	Test conditions	Min.	Typ.	Max.	Unit
$V_{IO}$	Input offset voltage	$-40^\circ\text{ C} < T_{amb} < +125^\circ\text{ C}$	-	0.2	6 7	mV
$\Delta V_{IO}$	Input offset voltage drift	$-40^\circ\text{ C} < T_{amb} < +125^\circ\text{ C}$	-	3	20	$\mu\text{V}/^\circ\text{C}$
$I_{IO}$	Input offset current <sup>(2)</sup>	$-40^\circ\text{ C} < T_{amb} < +125^\circ\text{ C}$	-	1	20 100	nA
$I_{IB}$	Input bias current <sup>(2)</sup>	$-40^\circ\text{ C} < T_{amb} < +125^\circ\text{ C}$	-	86	160 300	nA
$I_{CC}$	Supply current	No load, output high, $V_{icm} = 0\text{ V}$ $-40^\circ\text{ C} < T_{amb} < +125^\circ\text{ C}$	-	77	95 125	$\mu\text{A}$
		No load, output low, $V_{icm} = 0\text{ V}$ $-40^\circ\text{ C} < T_{amb} < +125^\circ\text{ C}$		89	115 135	
$I_{SC}$	Short circuit current	Source Sink	-	51 40	-	mA
$V_{OH}$	Output voltage high	$I_{source} = 4\text{ mA}$ $-40^\circ\text{ C} < T_{amb} < +125^\circ\text{ C}$	4.80 4.70	4.84	-	V
$V_{OL}$	Output voltage low	$I_{sink} = 4\text{ mA}$ $-40^\circ\text{ C} < T_{amb} < +125^\circ\text{ C}$	-	130	180 250	mV
CMRR	Common mode rejection ratio	$0 < V_{icm} < 5\text{ V}$	-	79	-	dB
SVR	Supply voltage rejection	$\Delta V_{CC} = 2\text{ to }5\text{ V}$	58	73	-	dB
$TP_{LH}$	Propagation delay <sup>(3)</sup> Low to High output level	$V_{icm} = 0\text{ V}$ , $f = 10\text{ kHz}$ , $C_L = 50\text{ pF}$ , Overdrive = 100 mV Overdrive = 20 mV	-	42	75	ns
				54	105	
$TP_{HL}$	Propagation delay <sup>(4)</sup> High to Low output level	$V_{icm} = 0\text{ V}$ , $f = 10\text{ kHz}$ , $C_L = 50\text{ pF}$ , Overdrive = 100 mV Overdrive = 20 mV	-	45	75	ns
				55	95	
$T_F$	Fall time	$f = 10\text{ kHz}$ , $C_L = 50\text{ pF}$ , $R_L = 10\text{ k}\Omega$ Overdrive = 100 mV	-	4	-	ns
$T_R$	Rise time	$f = 10\text{ kHz}$ , $C_L = 50\text{ pF}$ , $R_L = 10\text{ k}\Omega$ Overdrive = 100 mV	-	4	-	ns

1. All values over the temperature range are guaranteed through correlation and simulation. No production test is performed at the temperature range limits.
2. Maximum values include unavoidable inaccuracies of the industrial tests.
3. Response time is measured 10%/90% of final output value with following conditions: Inverting input voltage (IN-) =  $V_{ICM}$  and Non-inverting input voltage (IN+) moving from  $V_{ICM} - 100\text{ mV}$  to  $V_{ICM} + \text{overdrive}$ .
4. Response time is measured 10%/90% of final output value with following conditions: Inverting input voltage (IN-) =  $V_{ICM}$  and Non-inverting input voltage (IN+) moving from  $V_{ICM} + 100\text{ mV}$  to  $V_{ICM} - \text{overdrive}$ .

Figure 1. Current consumption vs. power supply voltage

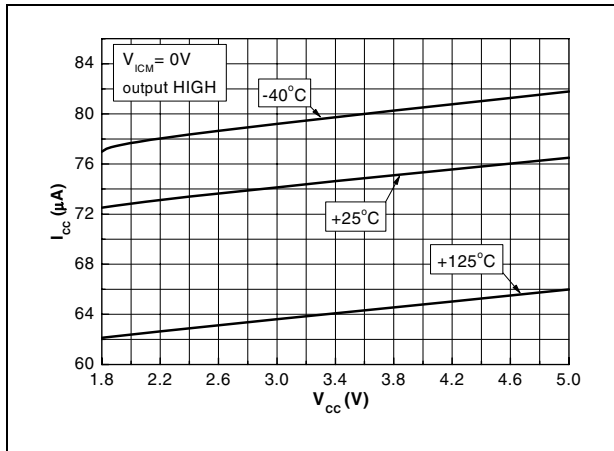

Figure 2. Current consumption vs. power supply voltage

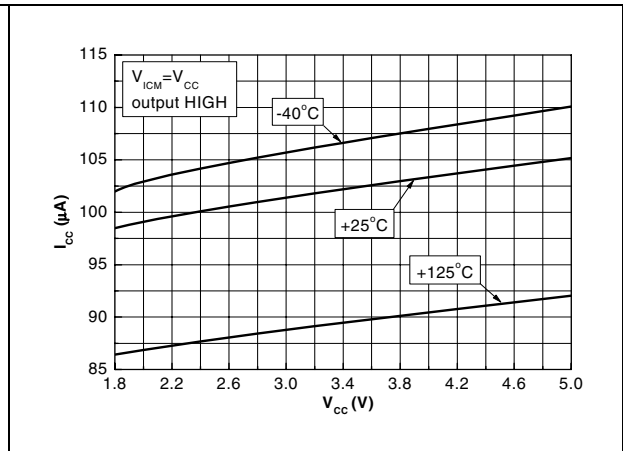

Figure 3. Current consumption vs. power supply voltage

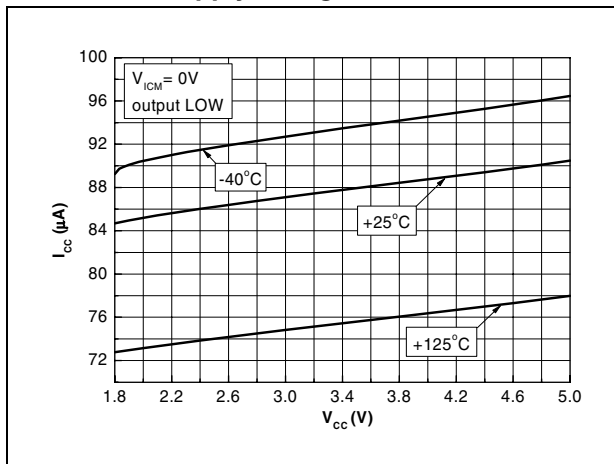

Figure 4. Current consumption vs. power supply voltage

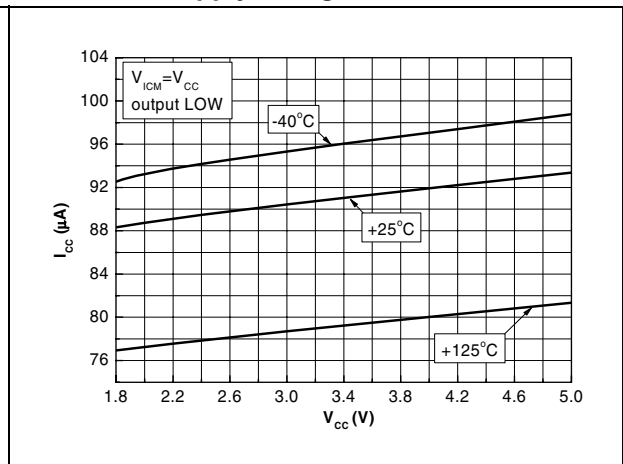

Figure 5. Output voltage vs. source current  $V_{CC} = 2V$

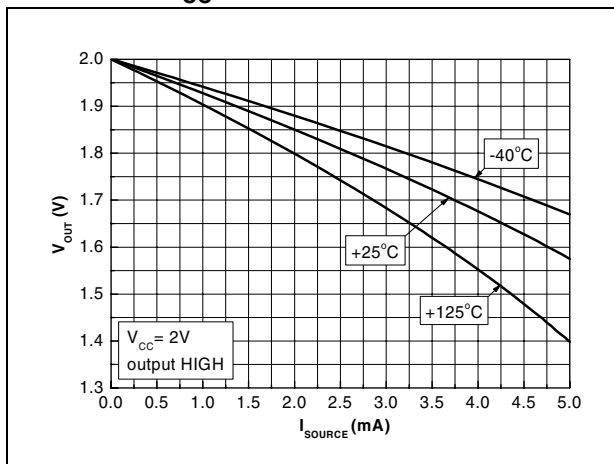
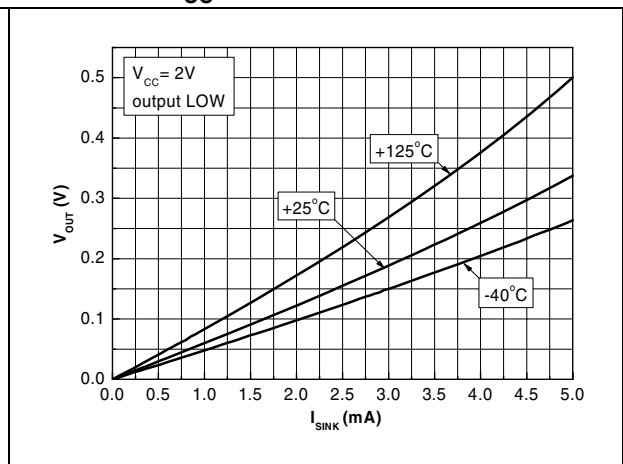
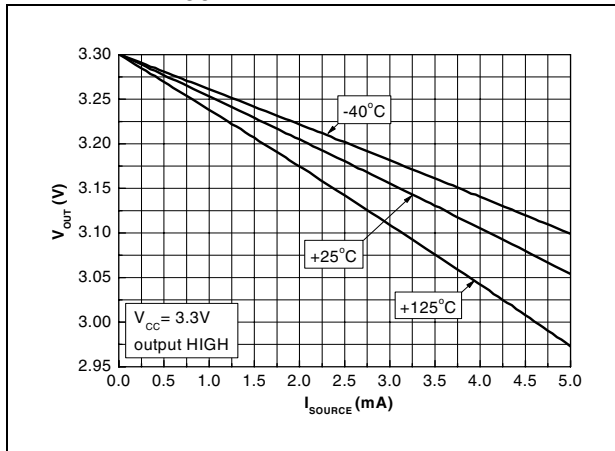

Figure 6. Output voltage vs. sink current  $V_{CC} = 2V$



**Figure 7. Output voltage vs. source current**  
 $V_{CC} = 3.3\text{ V}$



**Figure 8. Output voltage vs. sink current**  
 $V_{CC} = 3.3\text{ V}$

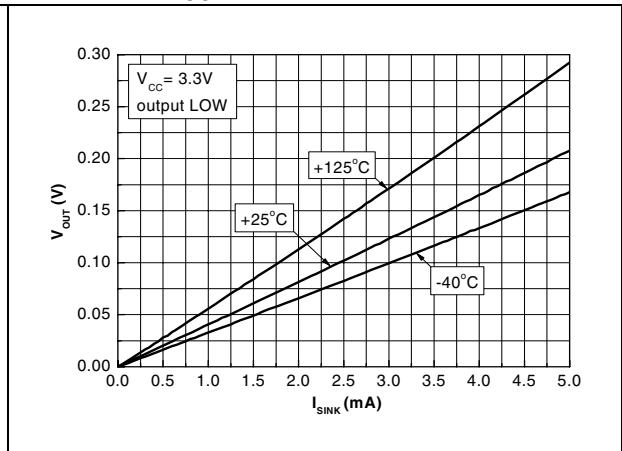

**Figure 9. Output Voltage vs. source current**  
 $V_{CC} = 5\text{ V}$

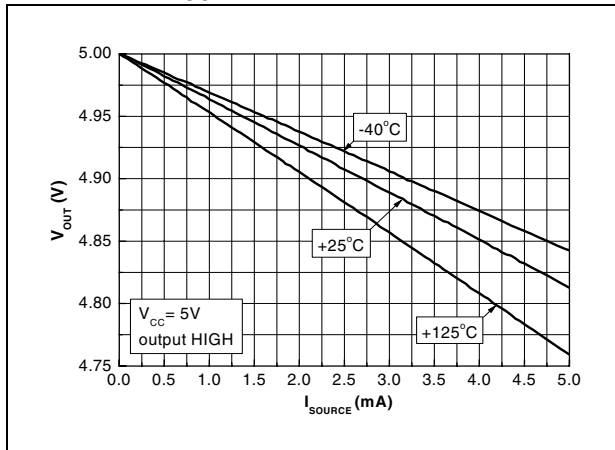

**Figure 10. Output voltage vs. sink current**  
 $V_{CC} = 5\text{ V}$

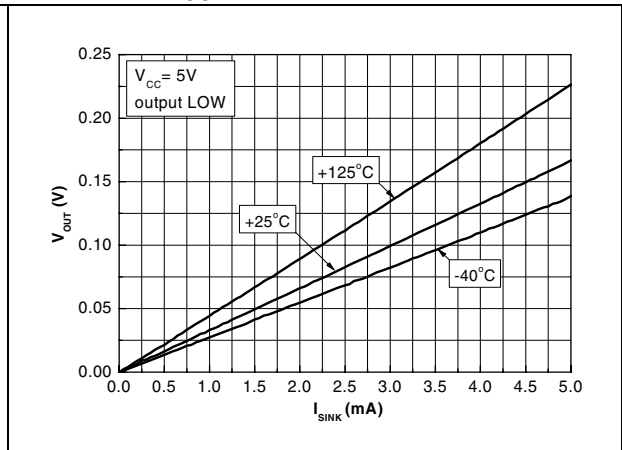

**Figure 11. Input offset voltage vs. temperature**

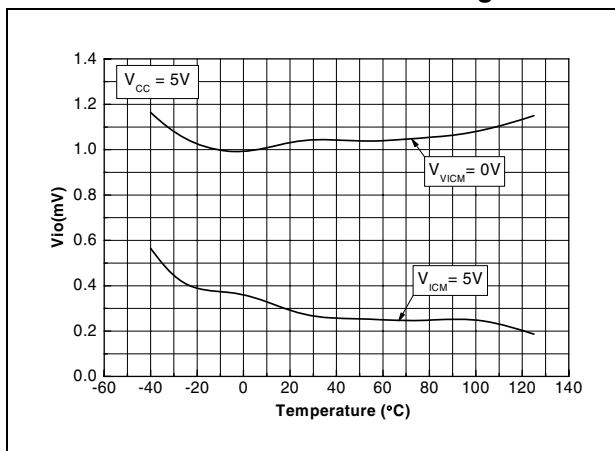

**Figure 12. Input bias current vs. temperature and input voltage**

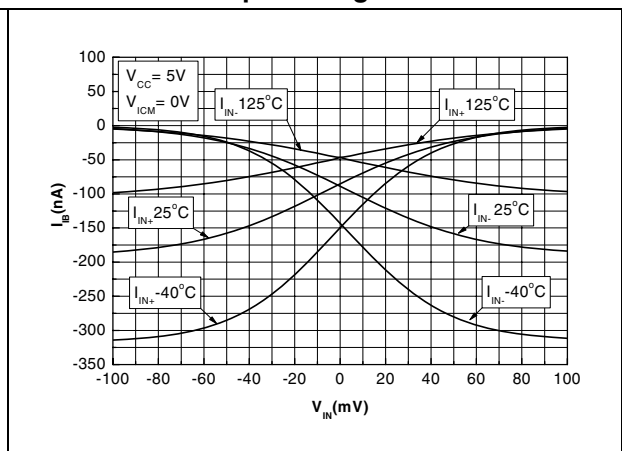

Figure 13. Current consumption vs. commutation frequency

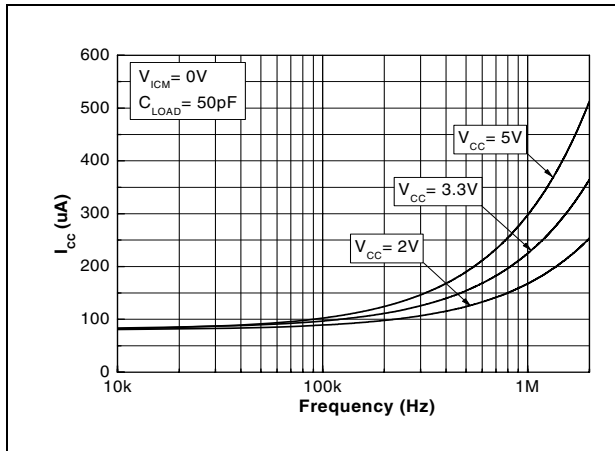

Figure 14. Propagation delay vs. overdrive  $V_{CC} = 2V$

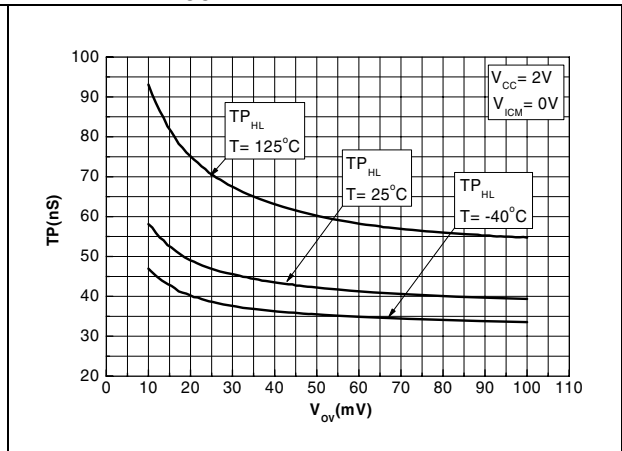

Figure 15. Propagation delay vs. overdrive  $V_{CC} = 2V$

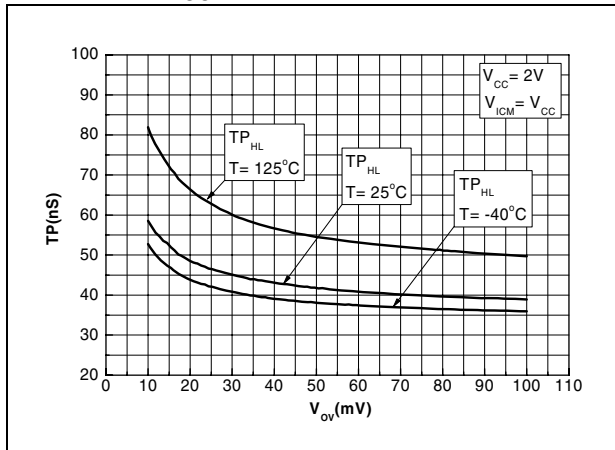

Figure 16. Propagation delay vs. overdrive  $V_{CC} = 2V$

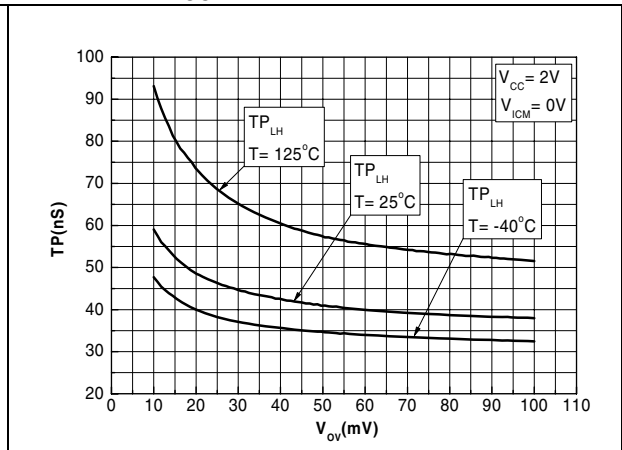

Figure 17. Propagation delay vs. overdrive  $V_{CC} = 2V$

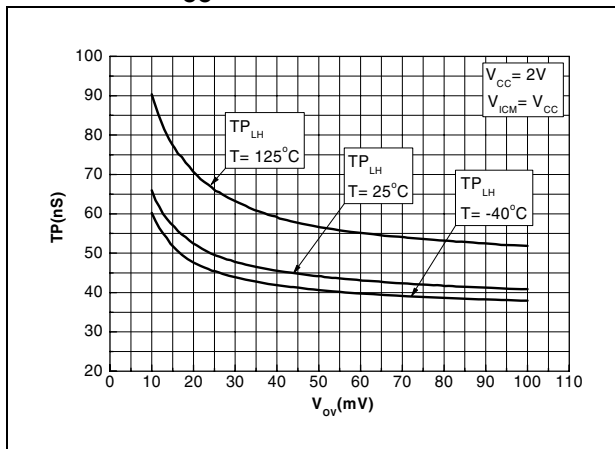

Figure 18. Propagation delay vs. overdrive  $V_{CC} = 3.3V$

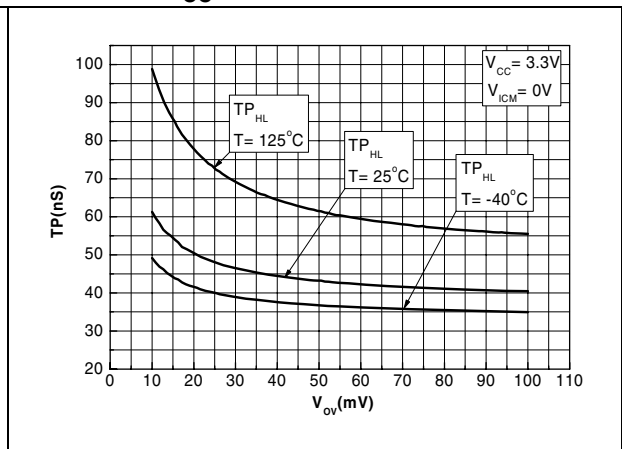



Figure 19. Propagation delay vs. overdrive  
 $V_{CC} = 3.3\text{ V}$

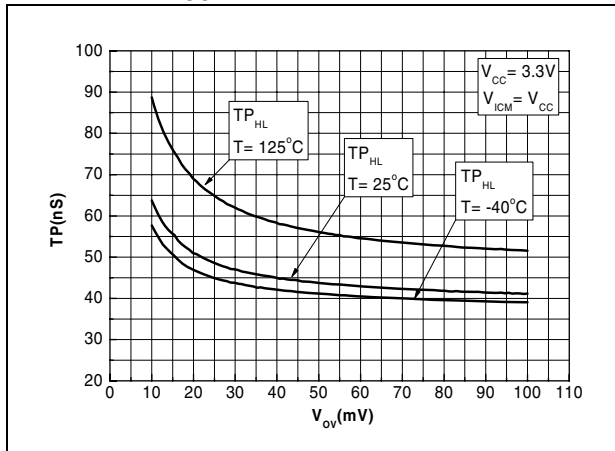

Figure 20. Propagation delay vs. overdrive  
 $V_{CC} = 3.3\text{ V}$

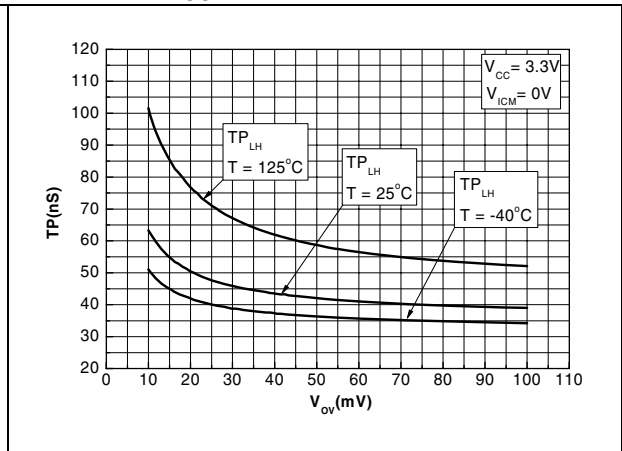

Figure 21. Propagation delay vs. overdrive  
 $V_{CC} = 3.3\text{ V}$

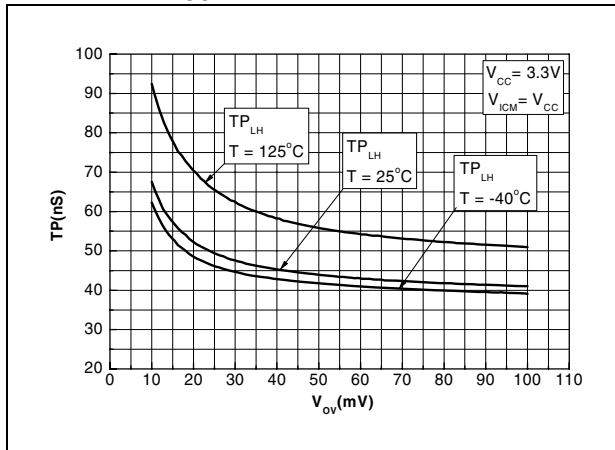

Figure 22. Propagation delay vs. overdrive  
 $V_{CC} = 5\text{ V}$

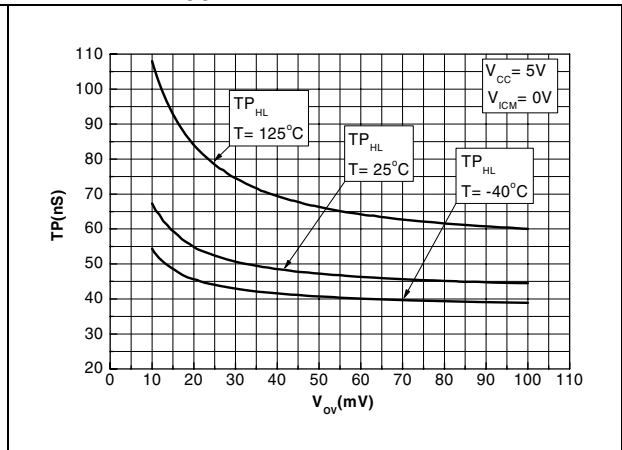

Figure 23. Propagation delay vs. overdrive  
 $V_{CC} = 5\text{ V}$

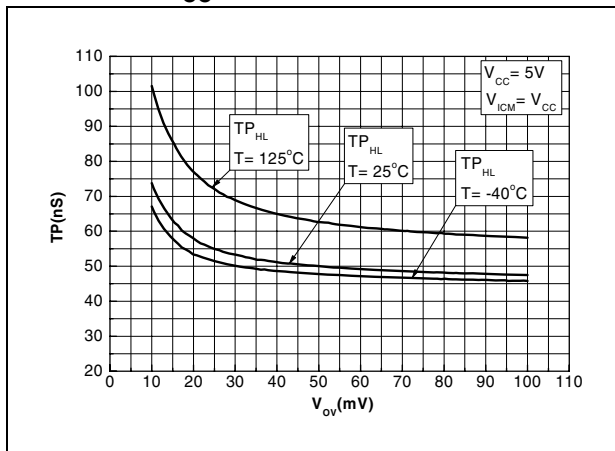

Figure 24. Propagation delay vs. overdrive  
 $V_{CC} = 5\text{ V}$

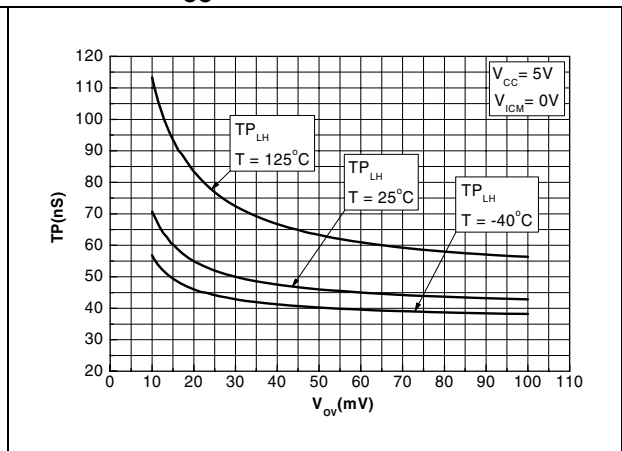

Figure 25. Propagation delay vs. overdrive  
 $V_{CC} = 5\text{ V}$

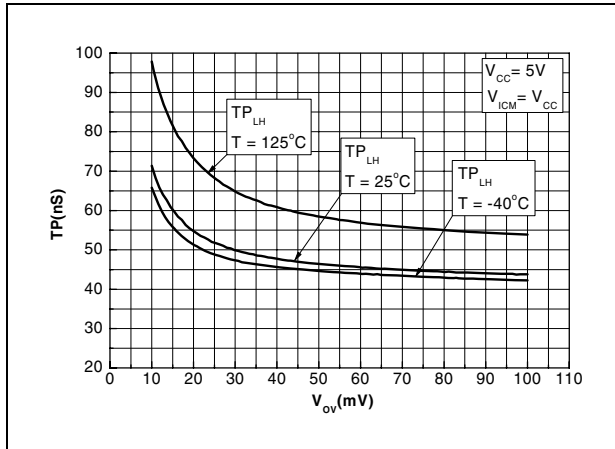

Figure 26. Propagation delay vs. temperature  
 $V_{CC} = 5\text{ V}$ , overdrive = 100 mV

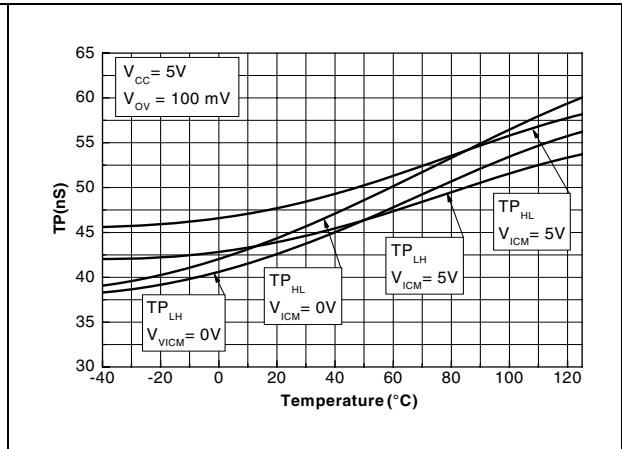
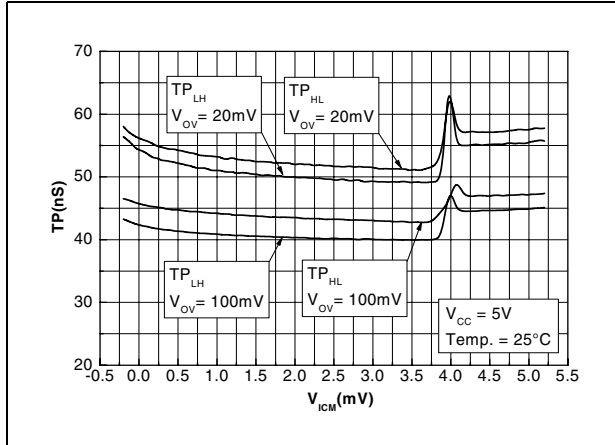

Figure 27. Propagation delay vs. common mode voltage,  $V_{CC} = 5\text{ V}$



### 3 Package information

In order to meet environmental requirements, ST offers these devices in different grades of ECOPACK® packages, depending on their level of environmental compliance. ECOPACK® specifications, grade definitions and product status are available at: [www.st.com](http://www.st.com). ECOPACK® is an ST trademark.

### 3.1 SOT23-5 package mechanical data

Figure 28. SOT23-5L package mechanical drawing

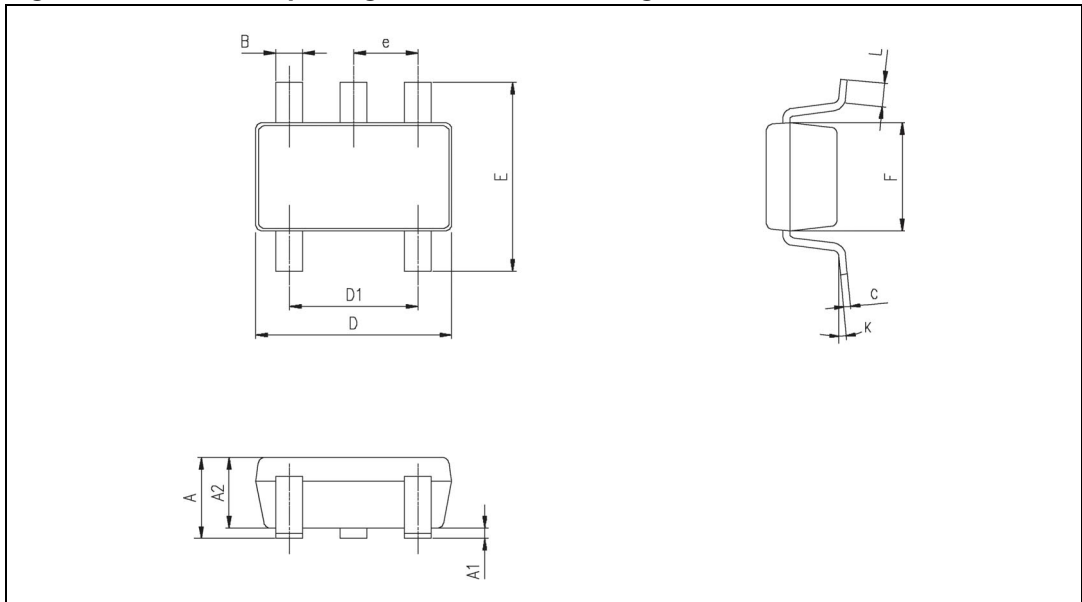

Table 6. SOT23-5L package mechanical data

Ref.	Dimensions					
	Millimeters			Inches		
	Min.	Typ.	Max.	Min.	Typ.	Max.
A	0.90	1.20	1.45	0.035	0.047	0.057
A1			0.15			0.006
A2	0.90	1.05	1.30	0.035	0.041	0.051
B	0.35	0.40	0.50	0.013	0.015	0.019
C	0.09	0.15	0.20	0.003	0.006	0.008
D	2.80	2.90	3.00	0.110	0.114	0.118
D1		1.90			0.075	
e		0.95			0.037	
E	2.60	2.80	3.00	0.102	0.110	0.118
F	1.50	1.60	1.75	0.059	0.063	0.069
L	0.10	0.35	0.60	0.004	0.013	0.023
K	0 degrees		10 degrees			

### 3.2 SC70-5 (SOT323-5) package mechanical data

Figure 29. SC70-5 (or SOT323-5) package mechanical drawing

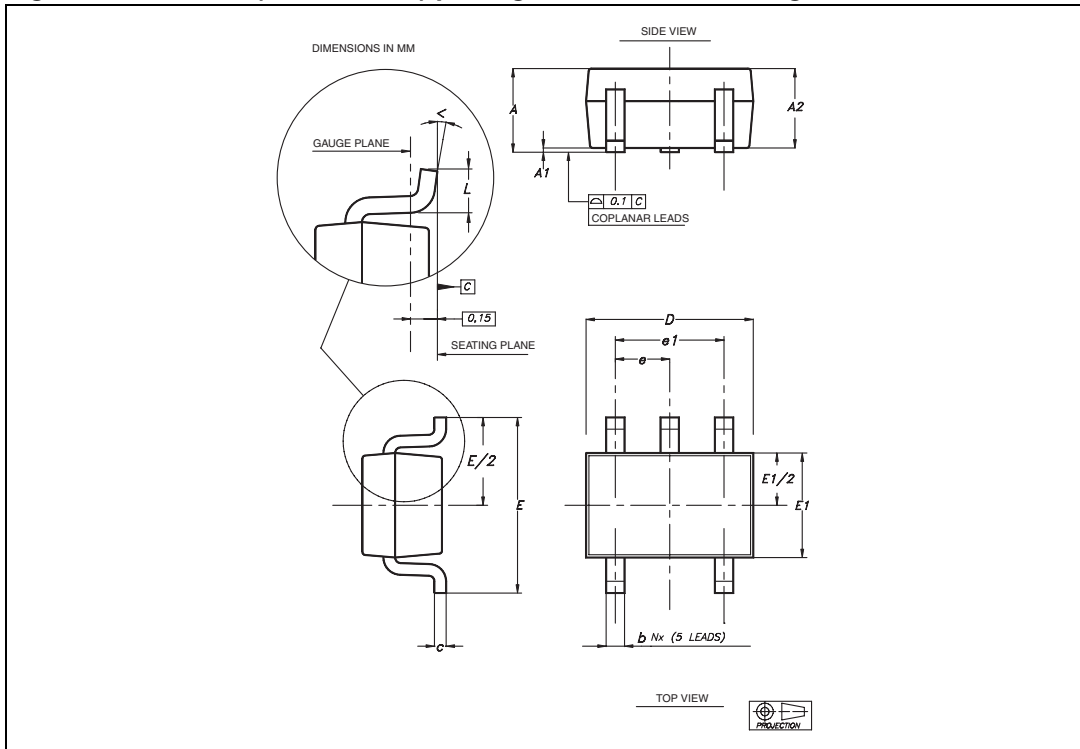

Table 7. SC70-5 (or SOT323-5) package mechanical data

Ref	Dimensions					
	Millimeters			Inches		
	Min	Typ	Max	Min	Typ	Max
A	0.80		1.10	0.315		0.043
A1			0.10			0.004
A2	0.80	0.90	1.00	0.315	0.035	0.039
b	0.15		0.30	0.006		0.012
c	0.10		0.22	0.004		0.009
D	1.80	2.00	2.20	0.071	0.079	0.087
E	1.80	2.10	2.40	0.071	0.083	0.094
E1	1.15	1.25	1.35	0.045	0.049	0.053
e		0.65			0.025	
e1		1.30			0.051	
L	0.26	0.36	0.46	0.010	0.014	0.018
<	0°		8°			

## 4 Ordering information

**Table 8. Order codes**

Order code	Temperature range	Package	Packing	Marking
TS3021ILT	-40°C, +125°C	SOT23-5	Tape & reel	K520
TS3021ICT		SC70-5	Tape & reel	K52

## 5 Revision history

**Table 9. Document revision history**

Date	Revision	Changes
01-Jun-2006	1	Initial release.
01-Sep-2006	2	Dual version added. Pinout of single TS3021 corrected. Modified temperature range for input common mode voltage.
22-Feb-2007	3	Addition of MiniSO-8 package for dual version.
17-Oct-2007	4	Marking corrected for SO-8 package. Thermal resistance values corrected in AMR table. Notes on ESD added in AMR table.
04-Dec-2008	5	Dual version (TS3022) removed. ESD tolerance modified in <a href="#">Table 1: Absolute maximum ratings</a> . Made the following changes in <a href="#">Table 3</a> : <ul style="list-style-type: none"> <li>– modified <math>V_{IO}</math> typical value and maximum limits.</li> <li>– modified <math>I_{IB}</math> typical value.</li> <li>– modified <math>I_{CC}</math> typical values and corrected maximum limits.</li> <li>– modified <math>I_{SC}</math> typical values.</li> <li>– modified <math>V_{OH}</math> and <math>V_{OL}</math> typical values.</li> <li>– modified CMRR and SVR typical values.</li> <li>– modified <math>TP_{HL}</math> and <math>TP_{LH}</math> typical values.</li> </ul> All curves modified.

**Please Read Carefully:**

Information in this document is provided solely in connection with ST products. STMicroelectronics NV and its subsidiaries ("ST") reserve the right to make changes, corrections, modifications or improvements, to this document, and the products and services described herein at any time, without notice.

All ST products are sold pursuant to ST's terms and conditions of sale.

Purchasers are solely responsible for the choice, selection and use of the ST products and services described herein, and ST assumes no liability whatsoever relating to the choice, selection or use of the ST products and services described herein.

No license, express or implied, by estoppel or otherwise, to any intellectual property rights is granted under this document. If any part of this document refers to any third party products or services it shall not be deemed a license grant by ST for the use of such third party products or services, or any intellectual property contained therein or considered as a warranty covering the use in any manner whatsoever of such third party products or services or any intellectual property contained therein.

**UNLESS OTHERWISE SET FORTH IN ST'S TERMS AND CONDITIONS OF SALE ST DISCLAIMS ANY EXPRESS OR IMPLIED WARRANTY WITH RESPECT TO THE USE AND/OR SALE OF ST PRODUCTS INCLUDING WITHOUT LIMITATION IMPLIED WARRANTIES OF MERCHANTABILITY, FITNESS FOR A PARTICULAR PURPOSE (AND THEIR EQUIVALENTS UNDER THE LAWS OF ANY JURISDICTION), OR INFRINGEMENT OF ANY PATENT, COPYRIGHT OR OTHER INTELLECTUAL PROPERTY RIGHT.**

**UNLESS EXPRESSLY APPROVED IN WRITING BY AN AUTHORIZED ST REPRESENTATIVE, ST PRODUCTS ARE NOT RECOMMENDED, AUTHORIZED OR WARRANTED FOR USE IN MILITARY, AIR CRAFT, SPACE, LIFE SAVING, OR LIFE SUSTAINING APPLICATIONS, NOR IN PRODUCTS OR SYSTEMS WHERE FAILURE OR MALFUNCTION MAY RESULT IN PERSONAL INJURY, DEATH, OR SEVERE PROPERTY OR ENVIRONMENTAL DAMAGE. ST PRODUCTS WHICH ARE NOT SPECIFIED AS "AUTOMOTIVE GRADE" MAY ONLY BE USED IN AUTOMOTIVE APPLICATIONS AT USER'S OWN RISK.**

Resale of ST products with provisions different from the statements and/or technical features set forth in this document shall immediately void any warranty granted by ST for the ST product or service described herein and shall not create or extend in any manner whatsoever, any liability of ST.

ST and the ST logo are trademarks or registered trademarks of ST in various countries.

Information in this document supersedes and replaces all information previously supplied.

The ST logo is a registered trademark of STMicroelectronics. All other names are the property of their respective owners.

© 2008 STMicroelectronics - All rights reserved

STMicroelectronics group of companies

Australia - Belgium - Brazil - Canada - China - Czech Republic - Finland - France - Germany - Hong Kong - India - Israel - Italy - Japan - Malaysia - Malta - Morocco - Singapore - Spain - Sweden - Switzerland - United Kingdom - United States of America

[www.st.com](http://www.st.com)