

# TLV1391 SINGLE DIFFERENTIAL COMPARATORS

SLCS128F – APRIL 1996 – REVISED JUNE 2007

- **Low-Voltage and Single-Supply Operation**  
 $V_{CC} = 2\text{ V to }7\text{ V}$
- **Common-Mode Voltage Range Includes Ground**
- **Fast Response Time . . . 0.7  $\mu\text{s}$  Typ**
- **Low Supply Current . . . 80  $\mu\text{A}$  Typ and 150  $\mu\text{A}$  Max**
- **Fully Specified at 3-V and 5-V Supply Voltages**

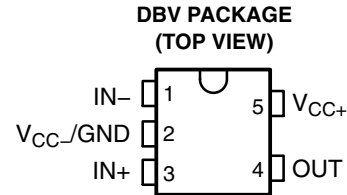

## description/ordering informaton

The TLV1391 is a differential comparator built using a Texas Instruments low-voltage, high-speed bipolar process. These devices have been developed specifically for low-voltage, single-supply applications. Their enhanced performance makes them excellent replacements for the LM393 in the improved 3-V and 5-V system designs.

The TLV1391, with its typical supply current of only 80  $\mu\text{A}$ , is ideal for low-power systems. Response time also has been improved to 0.7  $\mu\text{s}$ .

## ORDERING INFORMATION

$T_A$	PACKAGE†		ORDERABLE PART NUMBER	TOP-SIDE MARKING‡
-0°C to 70°C	SOT-23-5 (DBV)	Reel of 3000	TLV1391CDBVR	Y3D_
		Reel of 250	TLV1391CDBVT	
-40°C to 85°C	SOT-23-5 (DBV)	Reel of 3000	TLV1391IDBVR	Y3E_
		Reel of 250	TLV1391IDBVT	

† Package drawings, standard packing quantities, thermal data, symbolization, and PCB design guidelines are available at [www.ti.com/sc/package](http://www.ti.com/sc/package).

‡ The actual top-side marking has one additional character that designates the wafer fab/assembly site.

## symbol (each comparator)

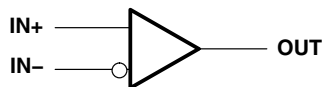

Please be aware that an important notice concerning availability, standard warranty, and use in critical applications of Texas Instruments semiconductor products and disclaimers thereto appears at the end of this data sheet.

PRODUCTION DATA information is current as of publication date. Products conform to specifications per the terms of Texas Instruments standard warranty. Production processing does not necessarily include testing of all parameters.

 **TEXAS  
INSTRUMENTS**

POST OFFICE BOX 655303 • DALLAS, TEXAS 75265

Copyright © 2007, Texas Instruments Incorporated

# TLV1391 SINGLE DIFFERENTIAL COMPARATORS

SLCS128F – APRIL 1996 – REVISED JUNE 2007

## equivalent schematic

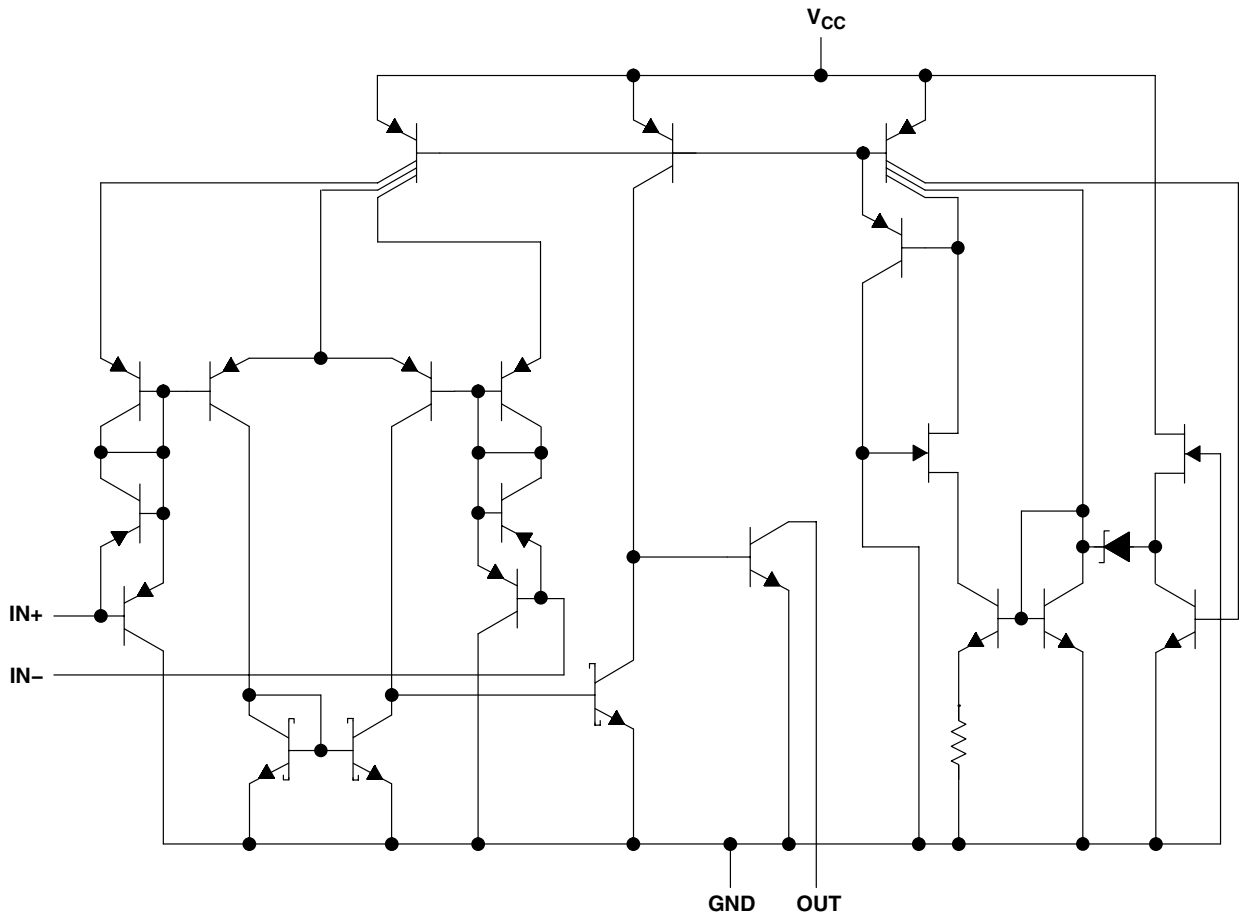

COMPONENT COUNT	
Transistors	26
Resistors	1
Diodes	4
Epi-FET	1

# TLV1391 SINGLE DIFFERENTIAL COMPARATORS

SLCS128F – APRIL 1996 – REVISED JUNE 2007

## absolute maximum ratings over operating free-air temperature range (unless otherwise noted)†

Supply voltage, $V_{CC}$ (see Note 1) .....	7 V
Differential input voltage, $V_{ID}$ (see Note 2) .....	$\pm 7$ V
Input voltage range, $V_I$ (any input) .....	–0.3 V to $V_{CC}$
Output voltage, $V_O$ .....	7 V
Output current, $I_O$ (each output) .....	20 mA
Duration of short-circuit current to GND (see Note 3) .....	Unlimited
Package thermal impedance, $\theta_{JA}$ (see Note 4 and 5) .....	206°C/W
Operating virtual junction temperature, $T_J$ .....	150°C
Lead temperature 1,6 mm (1/16 inch) from case for 10 seconds .....	260°C
Storage temperature range, $T_{stg}$ .....	–65°C to 150°C

† Stresses beyond those listed under “absolute maximum ratings” may cause permanent damage to the device. These are stress ratings only, and functional operation of the device at these or any other conditions beyond those indicated under “recommended operating conditions” is not implied. Exposure to absolute-maximum-rated conditions for extended periods may affect device reliability.

- NOTES:
1. All voltage values, except differential voltages, are with respect to the network GND.
  2. Differential voltages are at the noninverting input with respect to the inverting input.
  3. Short circuits from the outputs to  $V_{CC}$  can cause excessive heating and eventual destruction of the chip.
  4. Maximum power dissipation is a function of  $T_J(\text{max})$ ,  $\theta_{JA}$ , and  $T_A$ . The maximum allowable power dissipation at any allowable ambient temperature is  $P_D = (T_J(\text{max}) - T_A)/\theta_{JA}$ . Operating at the absolute maximum  $T_J$  of 150°C can impact reliability.
  5. The package thermal impedance is calculated in accordance with JESD 51-7.

## recommended operating conditions

		MIN	MAX	UNIT
$V_{CC}$	Supply voltage	2	7	V
$T_A$	Operating free-air temperature	TLV1391C	0	70
		TLV1391I	–40	85



# TLV1391

## SINGLE DIFFERENTIAL COMPARATORS

SLCS128F – APRIL 1996 – REVISED JUNE 2007

### electrical characteristics, $V_{CC} = 3\text{ V}$

PARAMETER	TEST CONDITIONS	$T_A$	MIN	TYP	MAX	UNIT
$V_{IO}$ Input offset voltage	$V_O = 1.4\text{ V}$ , $V_{IC} = V_{ICR}(\text{min})$	25°C		1.5	5	mV
		Full range			9	
$V_{ICR}$ Common-mode input voltage range		25°C	0 to $V_{CC}-1.5$	0 to $V_{CC}-1.2$		V
		Full range	0 to $V_{CC}-2$			
$V_{OL}$ Low-level output voltage	$V_{ID} = -1\text{ V}$ , $I_{OL} = 500\text{ }\mu\text{A}$	Full range		120	300	mV
$I_{IO}$ Input offset current	$V_O = 1.4\text{ V}$	25°C		5	50	nA
		Full range			150	
$I_{IB}$ Input bias current	$V_O = 1.4\text{ V}$	25°C		-40	-250	nA
		Full range			-400	
$I_{OH}$ High-level output current	$V_{ID} = 1\text{ V}$ , $V_{OH} = 3\text{ V}$	25°C		0.1		nA
	$V_{ID} = 1\text{ V}$ , $V_{OH} = 5\text{ V}$	Full range			100	
$I_{OL}$ Low-level output current	$V_{ID} = -1\text{ V}$ , $V_{OL} = 1.5\text{ V}$	25°C	500			$\mu\text{A}$
$I_{CC(H)}$ High-level supply current	$V_O = V_{OH}$	25°C		80	125	$\mu\text{A}$
		Full range			150	
$I_{CC(L)}$ Low-level supply current	$V_O = V_{OL}$	25°C		80	125	$\mu\text{A}$
		Full range			150	

### switching characteristics, $V_{CC} = 3\text{ V}$ , $C_L = 15\text{ pF}^\dagger$ , $T_A = 25^\circ\text{C}$

PARAMETER	TEST CONDITIONS	TYP	UNIT
Response time	100-mV input step with 5-mV overdrive, $R_L = 5.1\text{ k}\Omega$	0.7	$\mu\text{s}$

<sup>†</sup>  $C_L$  includes the probe and jig capacitance.



# TLV1391 SINGLE DIFFERENTIAL COMPARATORS

SLCS128F – APRIL 1996 – REVISED JUNE 2007

## electrical characteristics, $V_{CC} = 5\text{ V}$

PARAMETER		TEST CONDITIONS	$T_A$	MIN	TYP	MAX	UNIT
$V_{IO}$	Input offset voltage	$V_O = 1.4\text{ V}$ , $V_{IC} = V_{ICR}(\text{min})$	25°C		1.5	5	mV
			Full range			9	
$V_{ICR}$	Common-mode input voltage range		25°C	0 to $V_{CC}-1.5$	0 to $V_{CC}-1.2$		V
			Full range		0 to $V_{CC}-2$		
$V_{OL}$	Low-level output voltage	$V_{ID} = -1\text{ V}$ , $I_{OL} = 500\text{ }\mu\text{A}$	Full range		120	300	mV
$I_{IO}$	Input offset current	$V_O = 1.4\text{ V}$	25°C		5	50	nA
			Full range			150	
$I_{IB}$	Input bias current	$V_O = 1.4\text{ V}$	25°C		-40	-250	nA
			Full range			-400	
$I_{OH}$	High-level output current	$V_{ID} = 1\text{ V}$ , $V_{OH} = 3\text{ V}$	25°C		0.1		nA
		$V_{ID} = 1\text{ V}$ , $V_{OH} = 5\text{ V}$	Full range			100	
$I_{OL}$	Low-level output current	$V_{ID} = -1\text{ V}$ , $V_{OL} = 1.5\text{ V}$	25°C	600			$\mu\text{A}$
$I_{CC(H)}$	High-level supply current	$V_O = V_{OH}$	25°C		100	150	$\mu\text{A}$
			Full range			175	
$I_{CC(L)}$	Low-level supply current	$V_O = V_{OL}$	25°C		100	150	$\mu\text{A}$
			Full range			175	

## switching characteristics, $V_{CC} = 5\text{ V}$ , $C_L = 15\text{ pF}^\dagger$ , $T_A = 25^\circ\text{C}$

PARAMETER	TEST CONDITIONS	TYP	UNIT
Response time	100-mV input step with 5-mV overdrive,	0.65	$\mu\text{s}$
	TTL-level input step,	0.18	

<sup>†</sup>  $C_L$  includes the probe and jig capacitance.

# TLV1391 SINGLE DIFFERENTIAL COMPARATORS

SLCS128F – APRIL 1996 – REVISED JUNE 2007

## TYPICAL CHARACTERISTICS

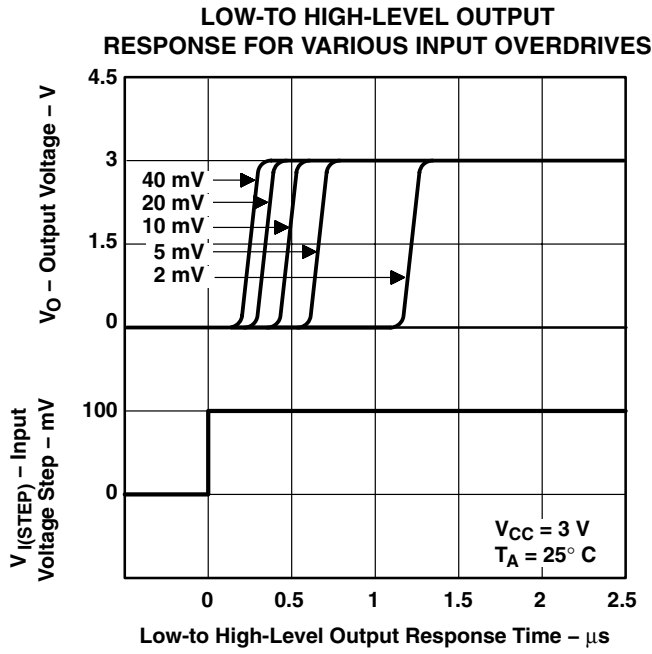

Figure 1

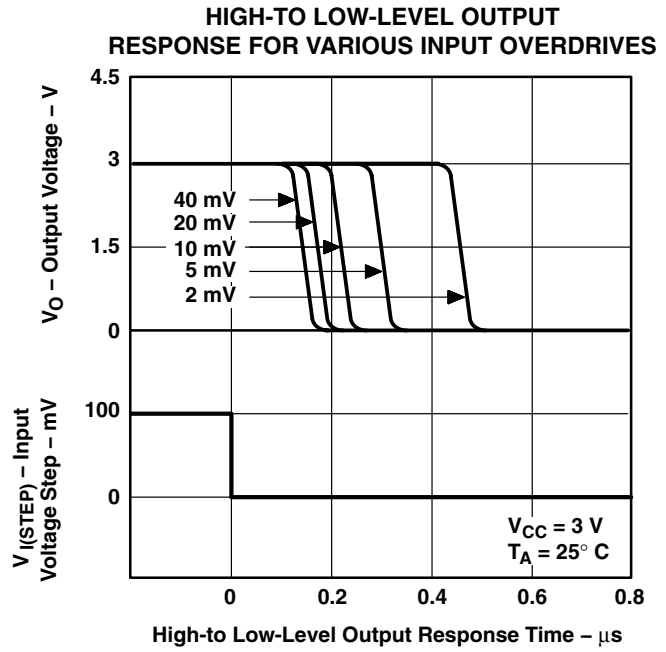

Figure 2

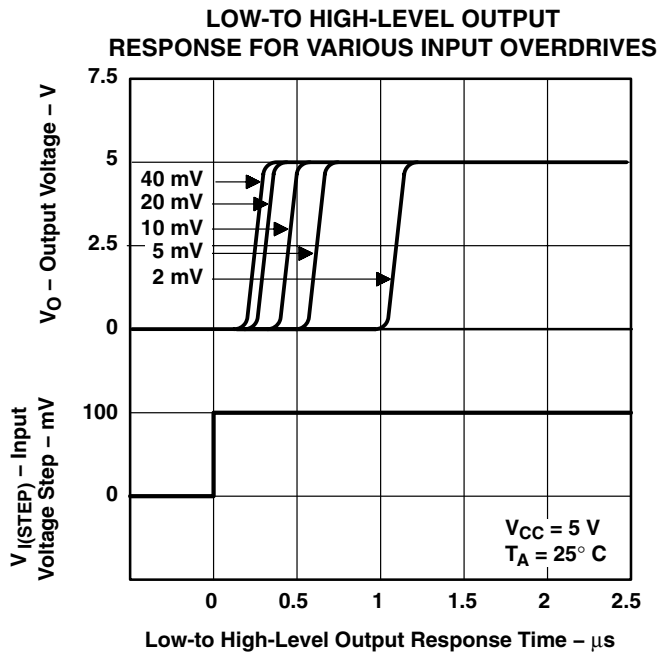

Figure 3

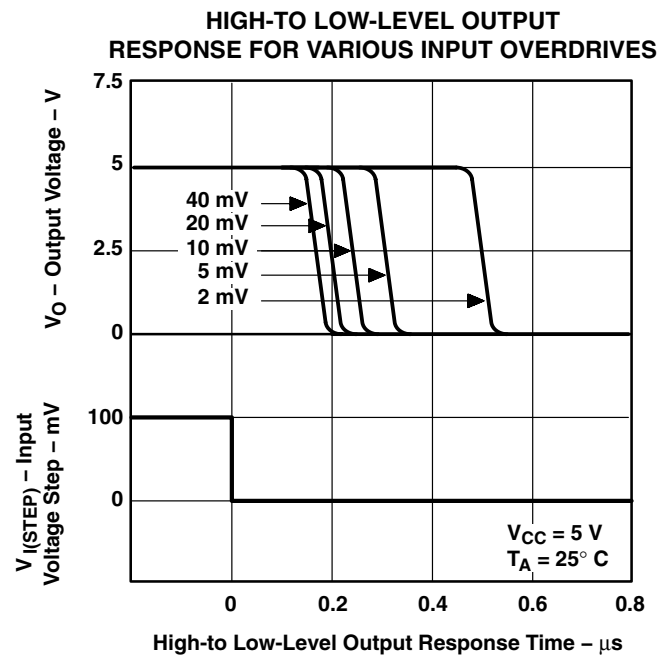

Figure 4

**PACKAGING INFORMATION**

Orderable Device	Status <sup>(1)</sup>	Package Type	Package Drawing	Pins	Package Qty	Eco Plan <sup>(2)</sup>	Lead/ Ball Finish	MSL Peak Temp <sup>(3)</sup>	Samples (Requires Login)
TLV1391CDBV	OBSOLETE	SOT-23	DBV	5		TBD	Call TI	Call TI	Replaced by TLV1391CDBVR
TLV1391CDBVR	ACTIVE	SOT-23	DBV	5	3000	Green (RoHS & no Sb/Br)	CU NIPDAU	Level-1-260C-UNLIM	Contact TI Distributor or Sales Office
TLV1391CDBVRE4	ACTIVE	SOT-23	DBV	5	3000	Green (RoHS & no Sb/Br)	CU NIPDAU	Level-1-260C-UNLIM	Contact TI Distributor or Sales Office
TLV1391CDBVRG4	ACTIVE	SOT-23	DBV	5	3000	Green (RoHS & no Sb/Br)	CU NIPDAU	Level-1-260C-UNLIM	Contact TI Distributor or Sales Office
TLV1391CDBVT	ACTIVE	SOT-23	DBV	5	250	Green (RoHS & no Sb/Br)	CU NIPDAU	Level-1-260C-UNLIM	Contact TI Distributor or Sales Office
TLV1391CDBVTE4	ACTIVE	SOT-23	DBV	5	250	Green (RoHS & no Sb/Br)	CU NIPDAU	Level-1-260C-UNLIM	Contact TI Distributor or Sales Office
TLV1391CDBVTG4	ACTIVE	SOT-23	DBV	5	250	Green (RoHS & no Sb/Br)	CU NIPDAU	Level-1-260C-UNLIM	Contact TI Distributor or Sales Office
TLV1391IDBV	OBSOLETE	SOT-23	DBV	5		TBD	Call TI	Call TI	Replaced by TLV1391IDBVR
TLV1391IDBVR	ACTIVE	SOT-23	DBV	5	3000	Green (RoHS & no Sb/Br)	CU NIPDAU	Level-1-260C-UNLIM	Contact TI Distributor or Sales Office
TLV1391IDBVRE4	ACTIVE	SOT-23	DBV	5	3000	Green (RoHS & no Sb/Br)	CU NIPDAU	Level-1-260C-UNLIM	Contact TI Distributor or Sales Office
TLV1391IDBVRG4	ACTIVE	SOT-23	DBV	5	3000	Green (RoHS & no Sb/Br)	CU NIPDAU	Level-1-260C-UNLIM	Contact TI Distributor or Sales Office
TLV1391IDBVT	ACTIVE	SOT-23	DBV	5	250	Green (RoHS & no Sb/Br)	CU NIPDAU	Level-1-260C-UNLIM	<a href="#">Purchase Samples</a>
TLV1391IDBVTE4	ACTIVE	SOT-23	DBV	5	250	Green (RoHS & no Sb/Br)	CU NIPDAU	Level-1-260C-UNLIM	<a href="#">Purchase Samples</a>
TLV1391IDBVTG4	ACTIVE	SOT-23	DBV	5	250	Green (RoHS & no Sb/Br)	CU NIPDAU	Level-1-260C-UNLIM	<a href="#">Purchase Samples</a>

<sup>(1)</sup> The marketing status values are defined as follows:

**ACTIVE:** Product device recommended for new designs.

**LIFEBUY:** TI has announced that the device will be discontinued, and a lifetime-buy period is in effect.

**NRND:** Not recommended for new designs. Device is in production to support existing customers, but TI does not recommend using this part in a new design.

**PREVIEW:** Device has been announced but is not in production. Samples may or may not be available.

**OBSOLETE:** TI has discontinued the production of the device.

---

<sup>(2)</sup> Eco Plan - The planned eco-friendly classification: Pb-Free (RoHS), Pb-Free (RoHS Exempt), or Green (RoHS & no Sb/Br) - please check <http://www.ti.com/productcontent> for the latest availability information and additional product content details.

**TBD:** The Pb-Free/Green conversion plan has not been defined.

**Pb-Free (RoHS):** TI's terms "Lead-Free" or "Pb-Free" mean semiconductor products that are compatible with the current RoHS requirements for all 6 substances, including the requirement that lead not exceed 0.1% by weight in homogeneous materials. Where designed to be soldered at high temperatures, TI Pb-Free products are suitable for use in specified lead-free processes.

**Pb-Free (RoHS Exempt):** This component has a RoHS exemption for either 1) lead-based flip-chip solder bumps used between the die and package, or 2) lead-based die adhesive used between the die and leadframe. The component is otherwise considered Pb-Free (RoHS compatible) as defined above.

**Green (RoHS & no Sb/Br):** TI defines "Green" to mean Pb-Free (RoHS compatible), and free of Bromine (Br) and Antimony (Sb) based flame retardants (Br or Sb do not exceed 0.1% by weight in homogeneous material)

<sup>(3)</sup> MSL, Peak Temp. -- The Moisture Sensitivity Level rating according to the JEDEC industry standard classifications, and peak solder temperature.

**Important Information and Disclaimer:** The information provided on this page represents TI's knowledge and belief as of the date that it is provided. TI bases its knowledge and belief on information provided by third parties, and makes no representation or warranty as to the accuracy of such information. Efforts are underway to better integrate information from third parties. TI has taken and continues to take reasonable steps to provide representative and accurate information but may not have conducted destructive testing or chemical analysis on incoming materials and chemicals. TI and TI suppliers consider certain information to be proprietary, and thus CAS numbers and other limited information may not be available for release.

In no event shall TI's liability arising out of such information exceed the total purchase price of the TI part(s) at issue in this document sold by TI to Customer on an annual basis.



**TAPE AND REEL INFORMATION**
**REEL DIMENSIONS**

**TAPE DIMENSIONS**

A0	Dimension designed to accommodate the component width
B0	Dimension designed to accommodate the component length
K0	Dimension designed to accommodate the component thickness
W	Overall width of the carrier tape
P1	Pitch between successive cavity centers

**TAPE AND REEL INFORMATION**

\*All dimensions are nominal

Device	Package Type	Package Drawing	Pins	SPQ	Reel Diameter (mm)	Reel Width W1 (mm)	A0 (mm)	B0 (mm)	K0 (mm)	P1 (mm)	W (mm)	Pin1 Quadrant
TLV1391CDBVR	SOT-23	DBV	5	3000	178.0	9.0	3.23	3.17	1.37	4.0	8.0	Q3
TLV1391CDBVT	SOT-23	DBV	5	250	178.0	9.0	3.23	3.17	1.37	4.0	8.0	Q3
TLV1391IDBVR	SOT-23	DBV	5	3000	180.0	8.4	3.23	3.17	1.37	4.0	8.0	Q3
TLV1391IDBVR	SOT-23	DBV	5	3000	179.0	8.4	3.2	3.2	1.4	4.0	8.0	Q3
TLV1391IDBVT	SOT-23	DBV	5	250	179.0	8.4	3.2	3.2	1.4	4.0	8.0	Q3

**TAPE AND REEL BOX DIMENSIONS**

\*All dimensions are nominal

Device	Package Type	Package Drawing	Pins	SPQ	Length (mm)	Width (mm)	Height (mm)
TLV1391CDBVR	SOT-23	DBV	5	3000	180.0	180.0	18.0
TLV1391CDBVT	SOT-23	DBV	5	250	180.0	180.0	18.0
TLV1391IDBVR	SOT-23	DBV	5	3000	202.0	201.0	28.0
TLV1391IDBVR	SOT-23	DBV	5	3000	203.0	203.0	35.0
TLV1391IDBVT	SOT-23	DBV	5	250	203.0	203.0	35.0

DBV (R-PDSO-G5)

PLASTIC SMALL-OUTLINE PACKAGE



- NOTES:
- A. All linear dimensions are in millimeters.
  - B. This drawing is subject to change without notice.
  - C. Body dimensions do not include mold flash or protrusion. Mold flash and protrusion shall not exceed 0.15 per side.
  - D. Falls within JEDEC MO-178 Variation AA.

DBV (R-PDSO-G5)

PLASTIC SMALL OUTLINE



- NOTES:
- A. All linear dimensions are in millimeters.
  - B. This drawing is subject to change without notice.
  - C. Customers should place a note on the circuit board fabrication drawing not to alter the center solder mask defined pad.
  - D. Publication IPC-7351 is recommended for alternate designs.
  - E. Laser cutting apertures with trapezoidal walls and also rounding corners will offer better paste release. Customers should contact their board assembly site for stencil design recommendations. Example stencil design based on a 50% volumetric metal load solder paste. Refer to IPC-7525 for other stencil recommendations.

## IMPORTANT NOTICE

Texas Instruments Incorporated and its subsidiaries (TI) reserve the right to make corrections, modifications, enhancements, improvements, and other changes to its products and services at any time and to discontinue any product or service without notice. Customers should obtain the latest relevant information before placing orders and should verify that such information is current and complete. All products are sold subject to TI's terms and conditions of sale supplied at the time of order acknowledgment.

TI warrants performance of its hardware products to the specifications applicable at the time of sale in accordance with TI's standard warranty. Testing and other quality control techniques are used to the extent TI deems necessary to support this warranty. Except where mandated by government requirements, testing of all parameters of each product is not necessarily performed.

TI assumes no liability for applications assistance or customer product design. Customers are responsible for their products and applications using TI components. To minimize the risks associated with customer products and applications, customers should provide adequate design and operating safeguards.

TI does not warrant or represent that any license, either express or implied, is granted under any TI patent right, copyright, mask work right, or other TI intellectual property right relating to any combination, machine, or process in which TI products or services are used. Information published by TI regarding third-party products or services does not constitute a license from TI to use such products or services or a warranty or endorsement thereof. Use of such information may require a license from a third party under the patents or other intellectual property of the third party, or a license from TI under the patents or other intellectual property of TI.

Reproduction of TI information in TI data books or data sheets is permissible only if reproduction is without alteration and is accompanied by all associated warranties, conditions, limitations, and notices. Reproduction of this information with alteration is an unfair and deceptive business practice. TI is not responsible or liable for such altered documentation. Information of third parties may be subject to additional restrictions.

Resale of TI products or services with statements different from or beyond the parameters stated by TI for that product or service voids all express and any implied warranties for the associated TI product or service and is an unfair and deceptive business practice. TI is not responsible or liable for any such statements.

TI products are not authorized for use in safety-critical applications (such as life support) where a failure of the TI product would reasonably be expected to cause severe personal injury or death, unless officers of the parties have executed an agreement specifically governing such use. Buyers represent that they have all necessary expertise in the safety and regulatory ramifications of their applications, and acknowledge and agree that they are solely responsible for all legal, regulatory and safety-related requirements concerning their products and any use of TI products in such safety-critical applications, notwithstanding any applications-related information or support that may be provided by TI. Further, Buyers must fully indemnify TI and its representatives against any damages arising out of the use of TI products in such safety-critical applications.

TI products are neither designed nor intended for use in military/aerospace applications or environments unless the TI products are specifically designated by TI as military-grade or "enhanced plastic." Only products designated by TI as military-grade meet military specifications. Buyers acknowledge and agree that any such use of TI products which TI has not designated as military-grade is solely at the Buyer's risk, and that they are solely responsible for compliance with all legal and regulatory requirements in connection with such use.

TI products are neither designed nor intended for use in automotive applications or environments unless the specific TI products are designated by TI as compliant with ISO/TS 16949 requirements. Buyers acknowledge and agree that, if they use any non-designated products in automotive applications, TI will not be responsible for any failure to meet such requirements.

Following are URLs where you can obtain information on other Texas Instruments products and application solutions:

### Products

Audio	<a href="http://www.ti.com/audio">www.ti.com/audio</a>
Amplifiers	<a href="http://amplifier.ti.com">amplifier.ti.com</a>
Data Converters	<a href="http://dataconverter.ti.com">dataconverter.ti.com</a>
DLP® Products	<a href="http://www.dlp.com">www.dlp.com</a>
DSP	<a href="http://dsp.ti.com">dsp.ti.com</a>
Clocks and Timers	<a href="http://www.ti.com/clocks">www.ti.com/clocks</a>
Interface	<a href="http://interface.ti.com">interface.ti.com</a>
Logic	<a href="http://logic.ti.com">logic.ti.com</a>
Power Mgmt	<a href="http://power.ti.com">power.ti.com</a>
Microcontrollers	<a href="http://microcontroller.ti.com">microcontroller.ti.com</a>
RFID	<a href="http://www.ti-rfid.com">www.ti-rfid.com</a>
OMAP Mobile Processors	<a href="http://www.ti.com/omap">www.ti.com/omap</a>
Wireless Connectivity	<a href="http://www.ti.com/wirelessconnectivity">www.ti.com/wirelessconnectivity</a>

### Applications

Automotive and Transportation	<a href="http://www.ti.com/automotive">www.ti.com/automotive</a>
Communications and Telecom	<a href="http://www.ti.com/communications">www.ti.com/communications</a>
Computers and Peripherals	<a href="http://www.ti.com/computers">www.ti.com/computers</a>
Consumer Electronics	<a href="http://www.ti.com/consumer-apps">www.ti.com/consumer-apps</a>
Energy and Lighting	<a href="http://www.ti.com/energy">www.ti.com/energy</a>
Industrial	<a href="http://www.ti.com/industrial">www.ti.com/industrial</a>
Medical	<a href="http://www.ti.com/medical">www.ti.com/medical</a>
Security	<a href="http://www.ti.com/security">www.ti.com/security</a>
Space, Avionics and Defense	<a href="http://www.ti.com/space-avionics-defense">www.ti.com/space-avionics-defense</a>
Video and Imaging	<a href="http://www.ti.com/video">www.ti.com/video</a>

TI E2E Community Home Page

[e2e.ti.com](http://e2e.ti.com)

Mailing Address: Texas Instruments, Post Office Box 655303, Dallas, Texas 75265  
Copyright © 2012, Texas Instruments Incorporated