

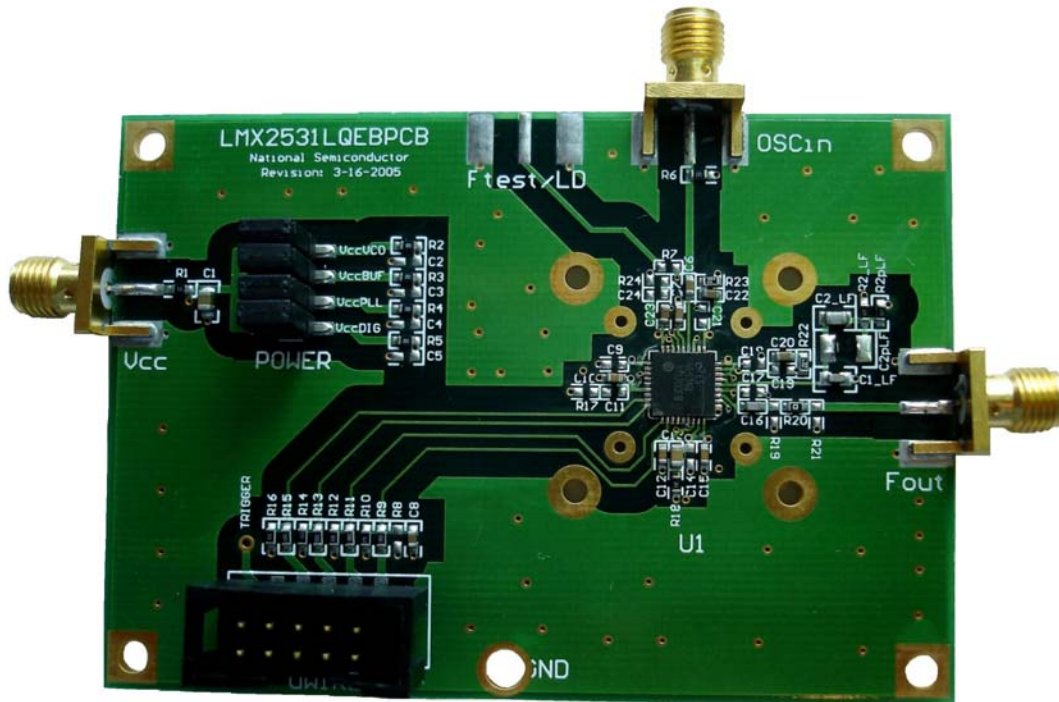

*National
Semiconductor*

LMX2531LQ1742 Evaluation Board Operating Instructions



**National Semiconductor Corporation
Wireless Communications, RF Products Group**

2900 Semiconductor Dr.
MS A2-600
Santa Clara, CA, 95052-8090

LMX2531LQ1742FPEB Rev 3.10.2006

TABLE OF CONTENTS

GENERAL DESCRIPTION	3
LOOP FILTER	3
PHASE NOISE	4
PHASE NOISE WITH NARROW LOOP FILTER (INTERNAL DIVIDE BY 2 DISABLED)	5
PHASE NOISE WITH NARROW LOOP FILTER (INTERNAL DIVIDE BY 2 ENABLED)	6
SPURS (INTERNAL DIVIDE BY 2 DISABLED).....	7
SPURS (INTERNAL DIVIDE BY 2 ENABLED)	8
CODELOADER SETTINGS	9
SCHEMATIC	11
TOP LAYER.....	13
MID LAYER 2 "POWER".....	15
BOTTOM LAYER "SIGNAL".....	16
TOP BUILD DIAGRAM.....	17

General Description

The LMX2531LQ1742 Evaluation Board simplifies evaluation of the LMX2531LQ1742 PLL/VCO synthesizer system. The board enables all performance measurements with no additional support circuitry. The evaluation board consists of a LMX2531LQ1742 device, and a cable assembly.

The cable assembly is bundled with the evaluation board for connecting to a PC through the parallel printer port. By means of **MICROWIRE™** serial port emulation, the *CodeLoader* software included can be run on a PC to facilitate the LMX2531LQ1742 internal register programming for the evaluation and measurement. In addition to this cable assembly, there is a microwire buffer board that ensures that the proper voltage levels are provided to the microwire inputs and also this reduces digital noise from computers through the parallel port.

Loop Filter			
Phase Margin	42.4 deg	K ϕ	90 uA
Loop Bandwidth	4.3 kHz	F _{comp}	2.5 MHz
TCXO Frequency	10 MHz	Output Frequency	1760 – 1866 MHz (DIV2=0) 880 – 933 MHz (DIV2=1)
Supply Voltage	3.0 Volts	VCO Gain	5.5 MHz/Volt

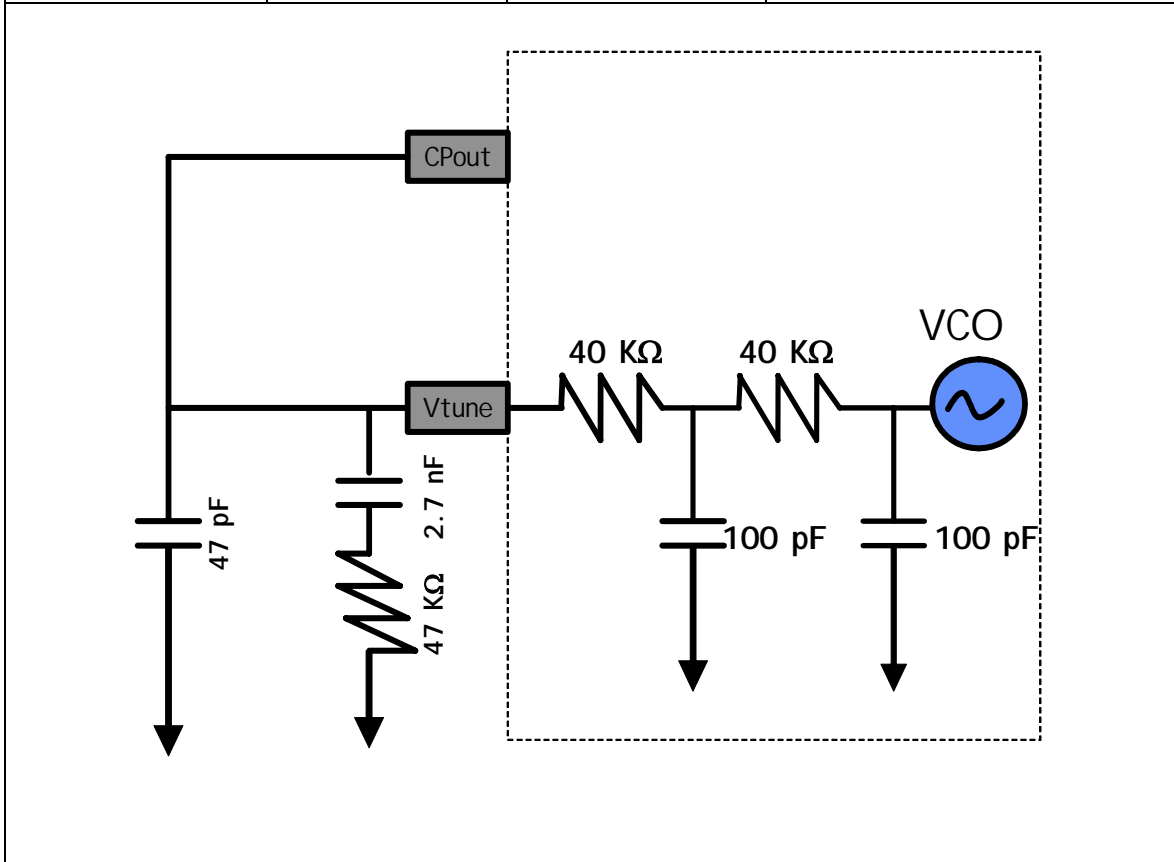

Phase Noise

Output Frequency = 1813 MHz
Internal Divide by 2 Disabled (DIV2=0)

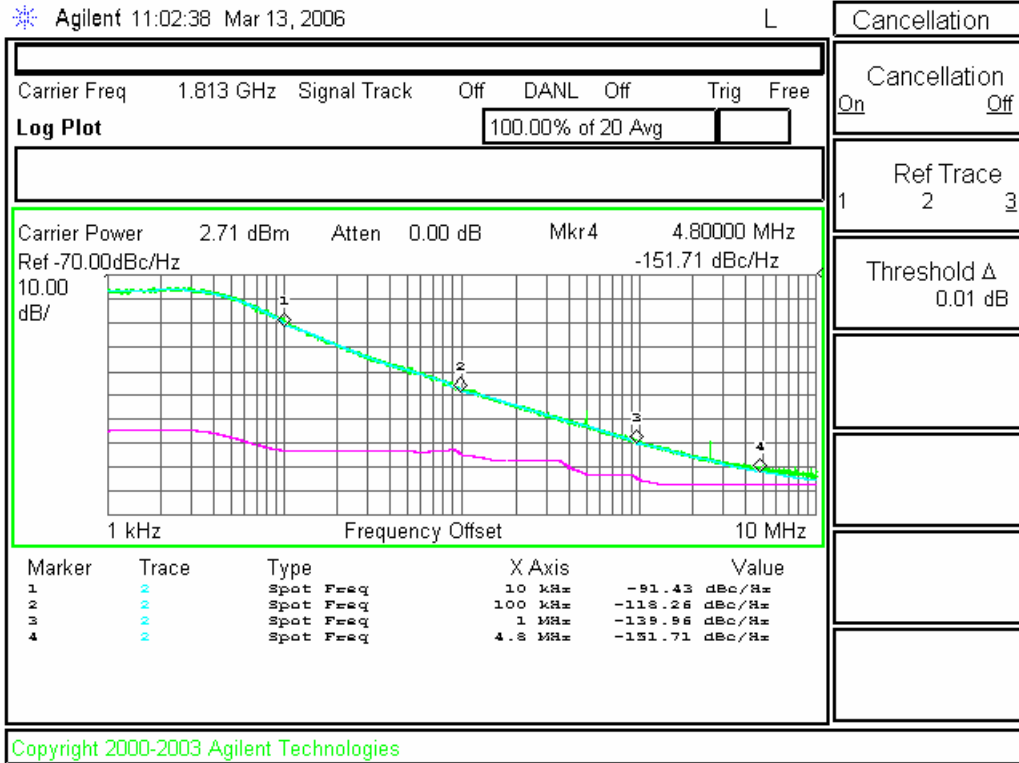

Output Frequency = 906.5 MHz
Internal Divide by 2 Enabled (DIV2=1)

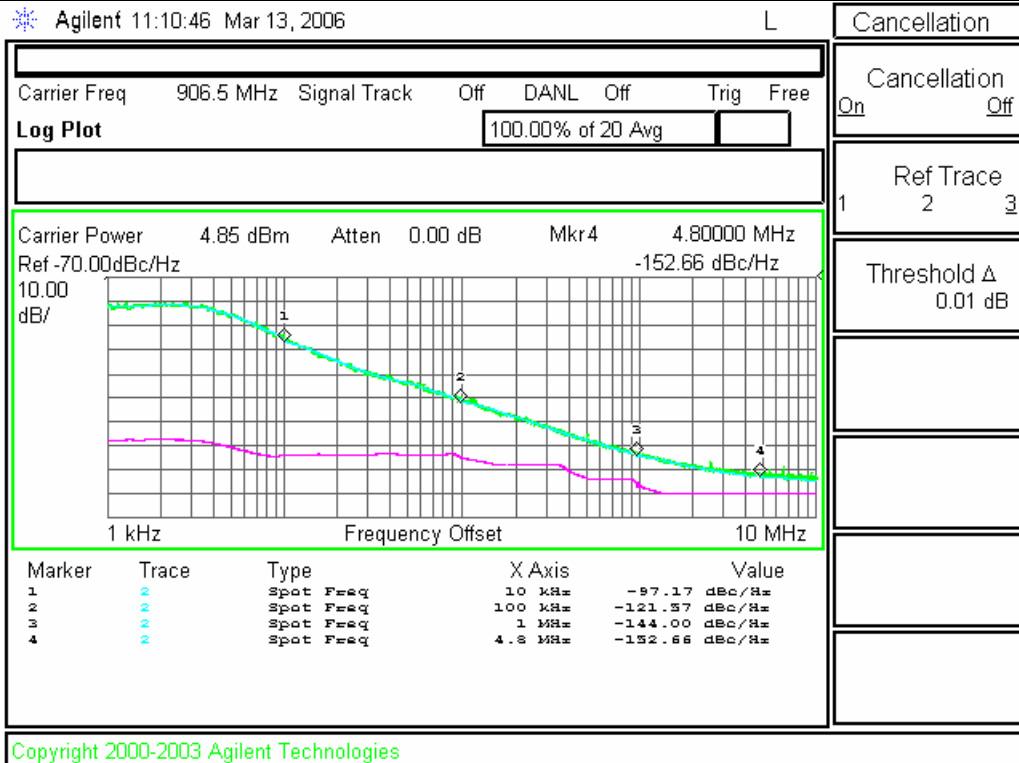

Phase Noise with Narrow Loop Filter (Internal Divide by 2 Disabled)

Fout = 1760 MHz

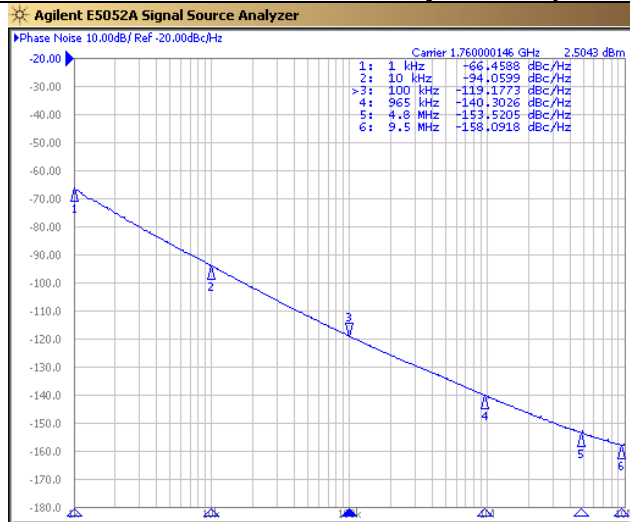

Fout = 1813 MHz

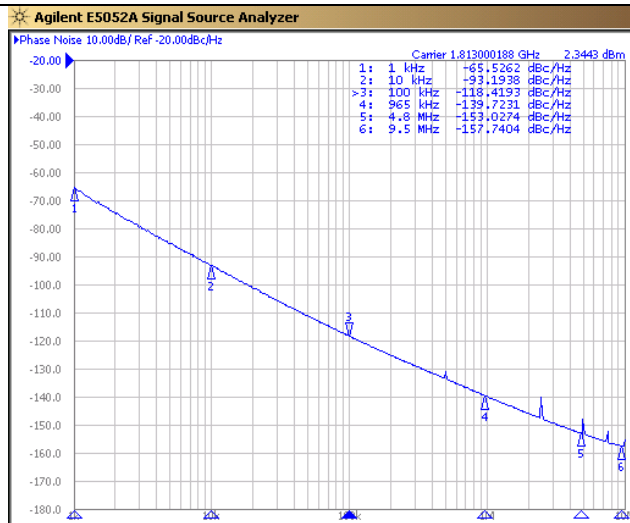

Fout = 1866 MHz

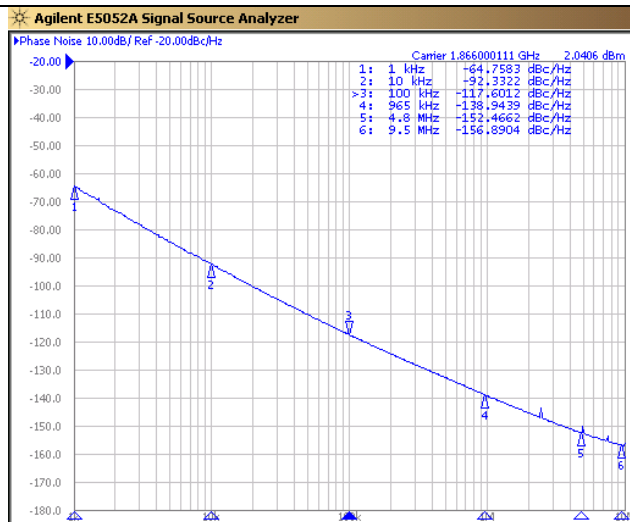

The plots to the left show the true phase noise capability of the VCO. In order to take these plots, a 20 Hz loop bandwidth was used with the E5052 spectrum analyzer. This is the most accurate and state of the art equipment.

At lower offsets, the measurements are more accurate because the impact of the PLL is removed. At higher offsets, the measurements are also more accurate because the E5052 spectrum analyzer has a much lower noise floor than the E4445A spectrum analyzer. Even though the E4445A has a noise cancellation feature, it only cancels out the thermal noise. It does not cancel out the phase noise of the LO inside the E4445A.

Phase Noise with Narrow Loop Filter (Internal Divide by 2 Enabled)

Fout = 880 MHz

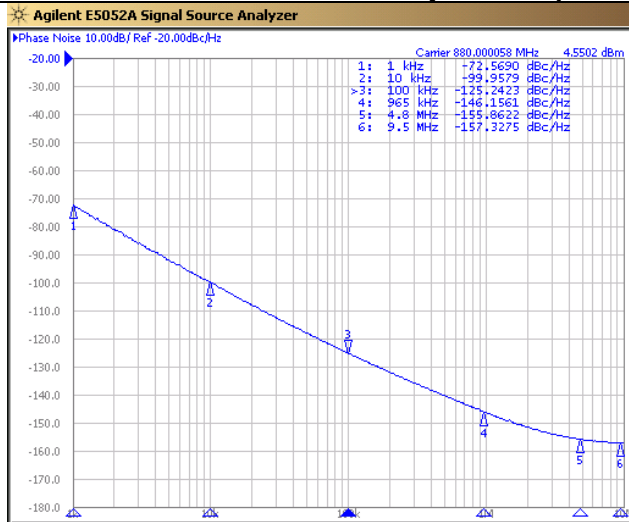

Fout = 906.5 MHz

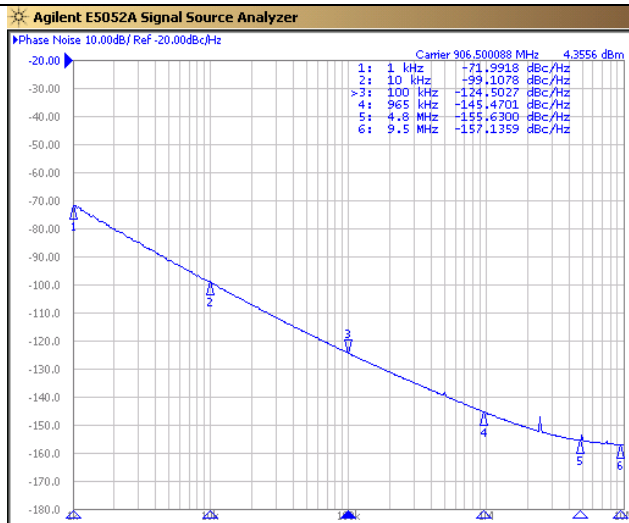

Fout = 933 MHz

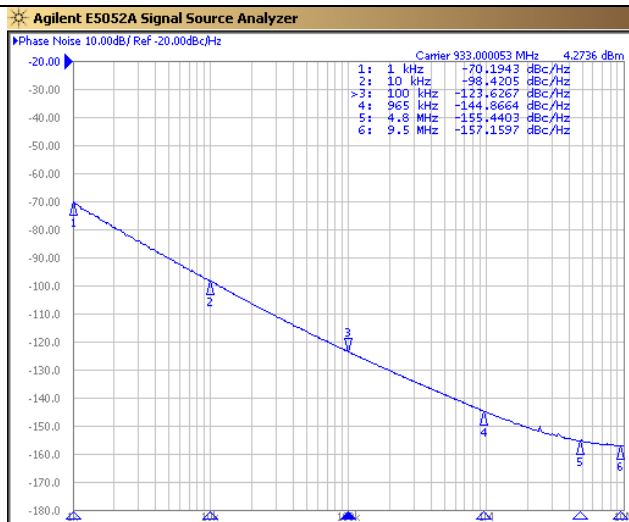

The plots to the left show the true phase noise capability of the VCO. In order to take these plots, a 20 Hz loop bandwidth was used with the E5052 spectrum analyzer. This is the most accurate and state of the art equipment.

At lower offsets, the measurements are more accurate because the impact of the PLL is removed. At higher offsets, the measurements are also more accurate because the E5052 spectrum analyzer has a much lower noise floor than the E4445A spectrum analyzer. Even though the E4445A has a noise cancellation feature, it only cancels out the thermal noise. It does not cancel out the phase noise of the LO inside the E4445A.

Spurs (Internal Divide by 2 Disabled)

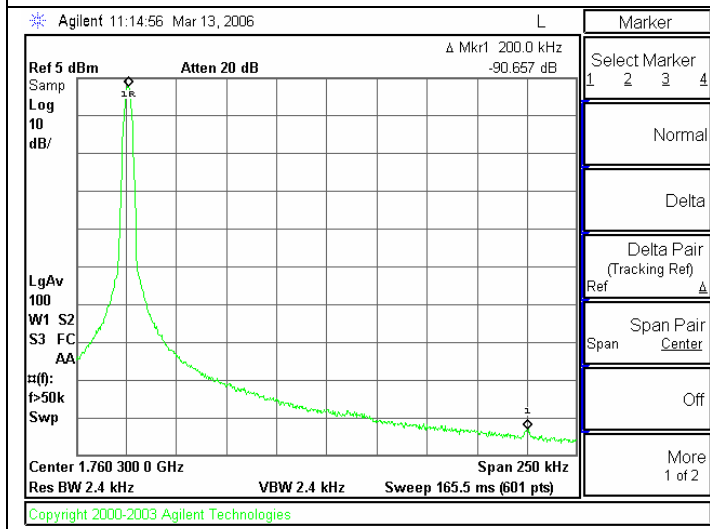

Spur at 200 kHz offset at a worst case frequency of 1760.2 MHz is -90.6 dBc. Worst case channels occur at exactly one channel spacing above or below a multiple of the crystal frequency.

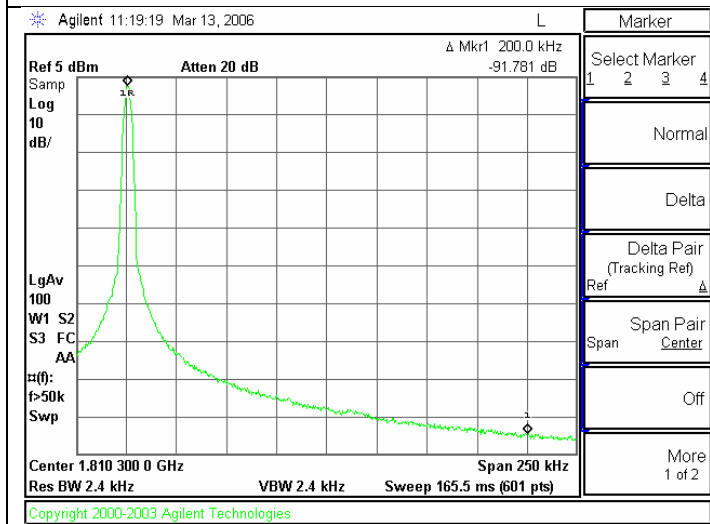

Spur at 200 kHz offset at a worst case frequency of 1810.2 MHz is -91.7 dBc.

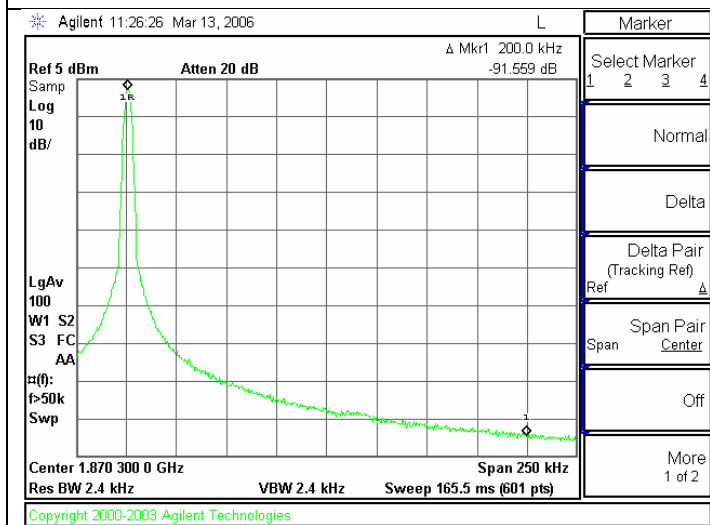

Spur at 200 kHz offset at a worst case frequency of 1870.2 MHz is -91.5 dBc.

Spurs (Internal Divide by 2 Enabled)

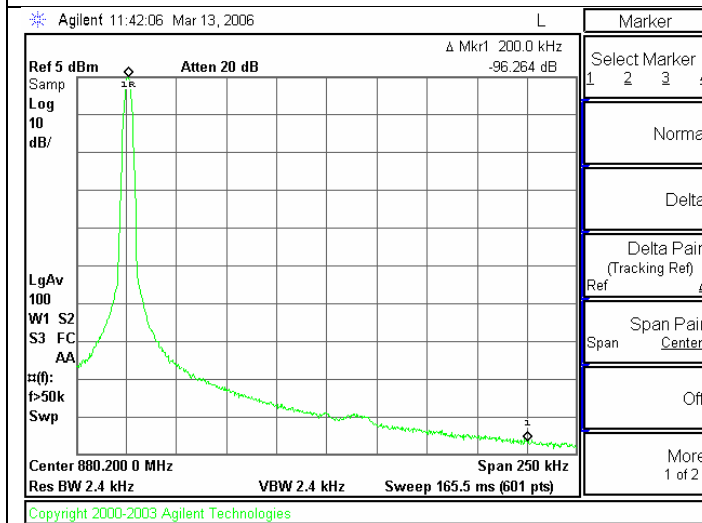

Spur at 200 kHz offset at a frequency of 880.1 MHz is -96.2 dBc. Since this mode uses the divide by 2 mode, the channel spacing here is actually 100 kHz. The spur at 100 kHz could be eliminated by doubling the channel spacing before the divider. The reason that the spur at 200 kHz is shown is to illustrate the theoretical 6 dB impact of the divider.

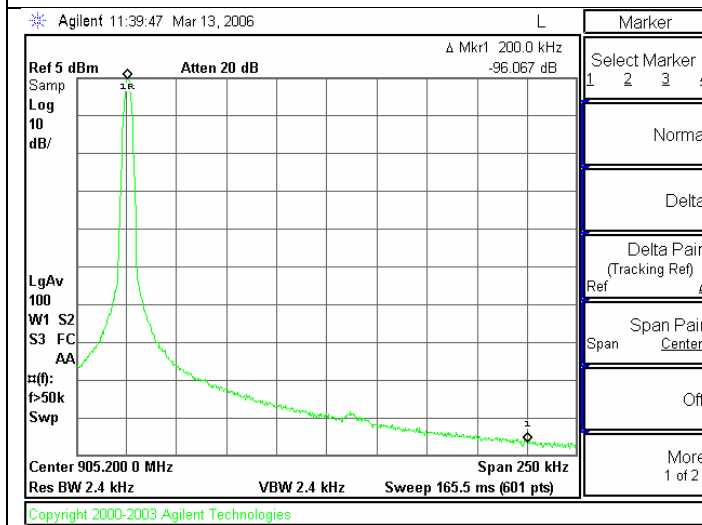

Spur at 200 kHz offset for a frequency of 905.1 MHz is better than -96.0 dBc.

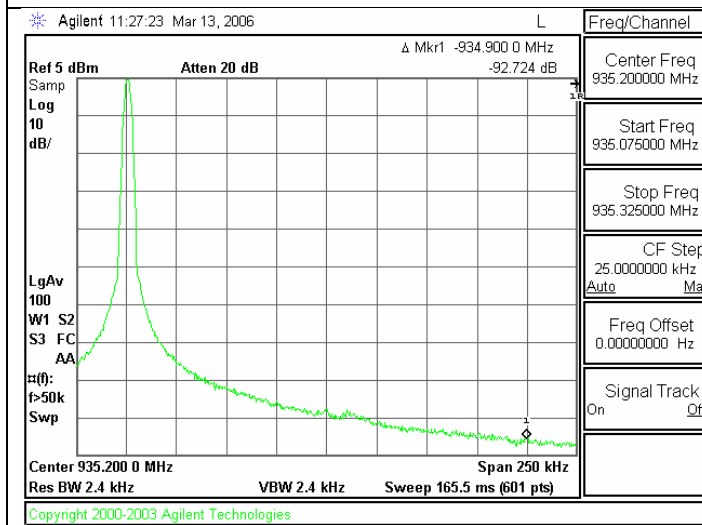

Spur at 200 kHz offset for a frequency of 935.1 MHz is better than -92.7 dBc.

CodeLoader Settings

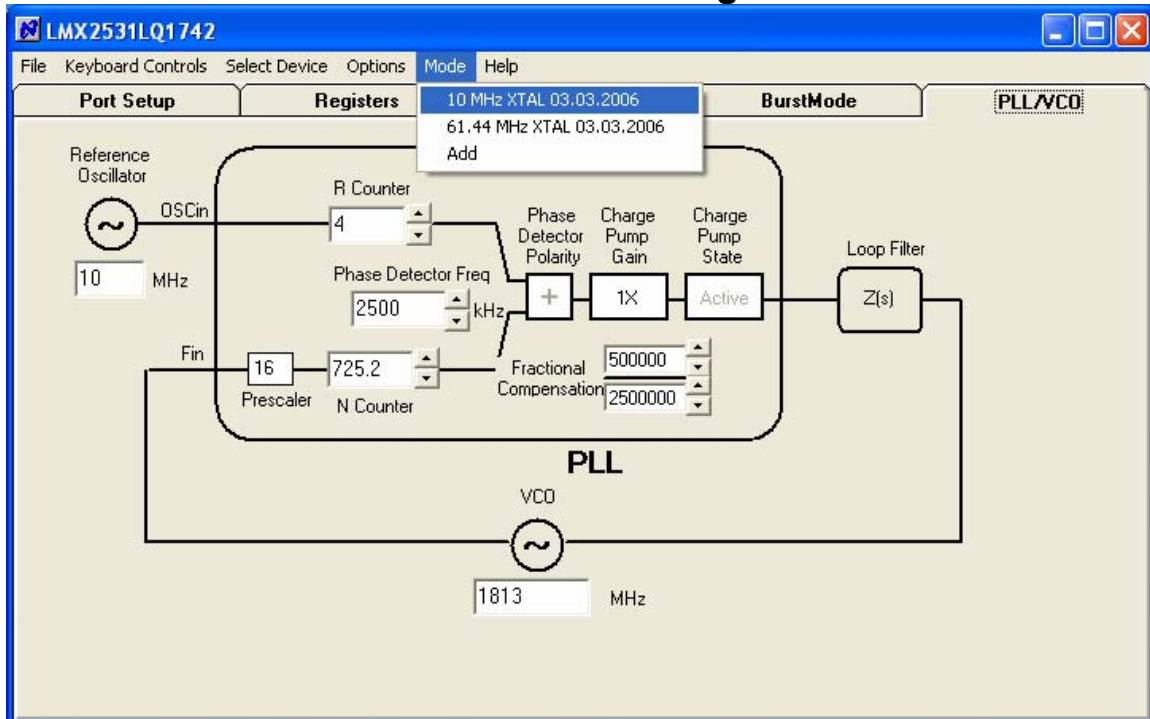

For the CodeLoader program, the default reference oscillator used for these instructions was 10 MHz, but there is a mode for a 61.44 MHz oscillator as well. If the bits become scrambled, their original state may be recalled by choosing the appropriate mode. Note that if the internal divide by 2 is enabled, the VCO frequency still reflects the VCO frequency before the divide by 2.

The screenshot shows the CodeLoader software interface for the LMX2531LQ1742, specifically the 'PLL/VCO' tab. The interface is divided into several sections:

- INITIALIZATION:** REG_RST
- VCO OUTPUT:** DIV2
- POWER CONTROLS:**
 - EN_PLL
 - EN_PLLLD01
 - EN_PLLLD02
 - EN_DIGLDO
 - EN_VCO
 - EN_VCOLDO
 - EN_OSC
- VCO PN OPTIMIZATION:** VCO_ACISEL: 8
- VCO FREQUENCY CAL:**
 - XTLDIV: Divide by 2
 - XTLSEL: <20 MHz
 - XTLMAN: 0
 - XTLMAN2
- FRACTIONAL CONTROLS:**
 - FDM
 - ORDER: 3rd Order Modulator
 - DITHER: Strong Dithering
- INTERNAL LOOP FILTER:**
 - EN_LPFLTR
 - C3_4_ADJ: C3=100pF, C4=100pF
 - R3_ADJ: 40 Kohm
 - R4_ADJ: 40 Kohm
- FASTLOCK CONTROLS:**
 - TOC: 0
 - ICPFL: 1X
 - R3_ADJ_FL: 0 Ohm
 - R4_ADJ_FL: 0 Ohm
- LOCK DETECT:**
 - LDDIV4
 - FoLD: Disabled
- Program Pins:**
 - CE
 - TRIGGER

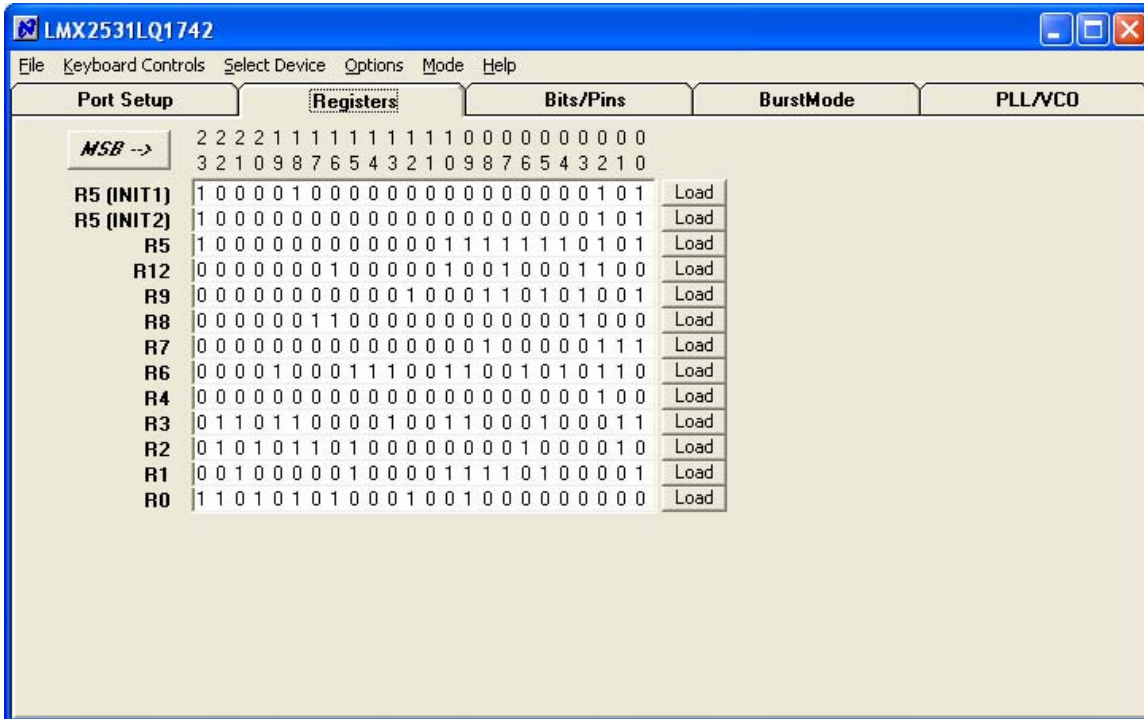

CodeLoader is set up to load the registers and initialize the part in the correct way. R5 (INIT1) and R5 (INIT 2) are just the R5 register being used to properly initialize the part. So a single CNT+L should load the part.

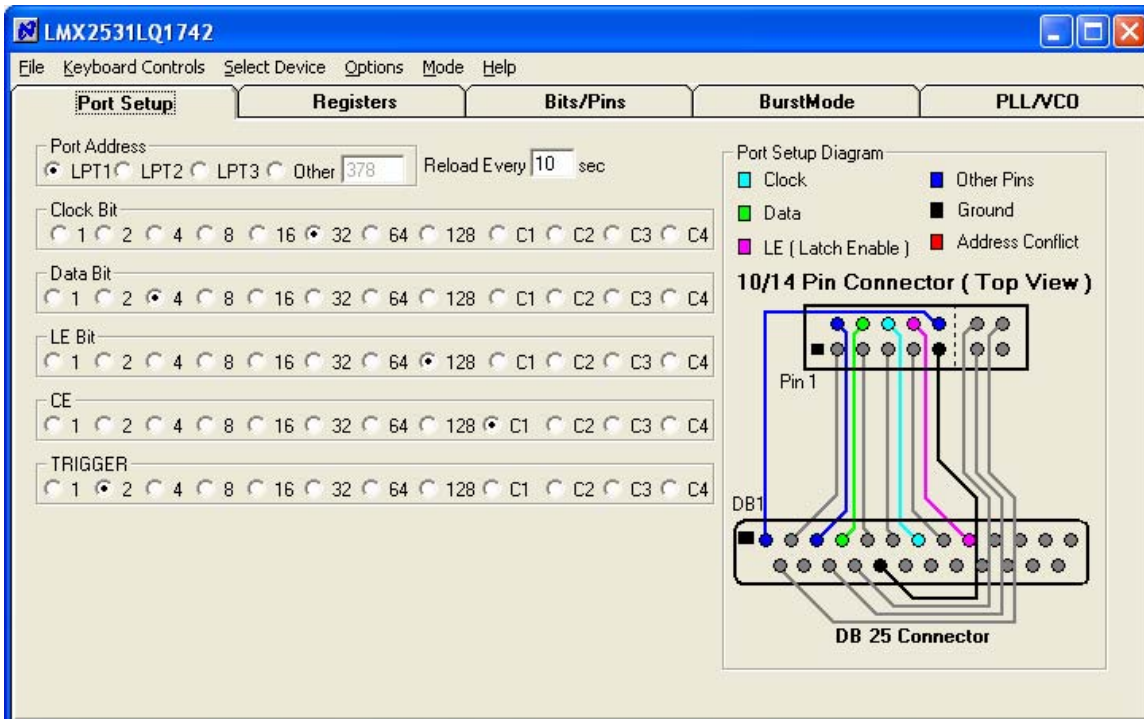

The port setup tells CodeLoader what information goes where. If this is wrong, the part will not program. Although LPT1 is usually correct, CodeLoader does not autodetect the correct port. On some laptops, it may be LPT3.

Schematic

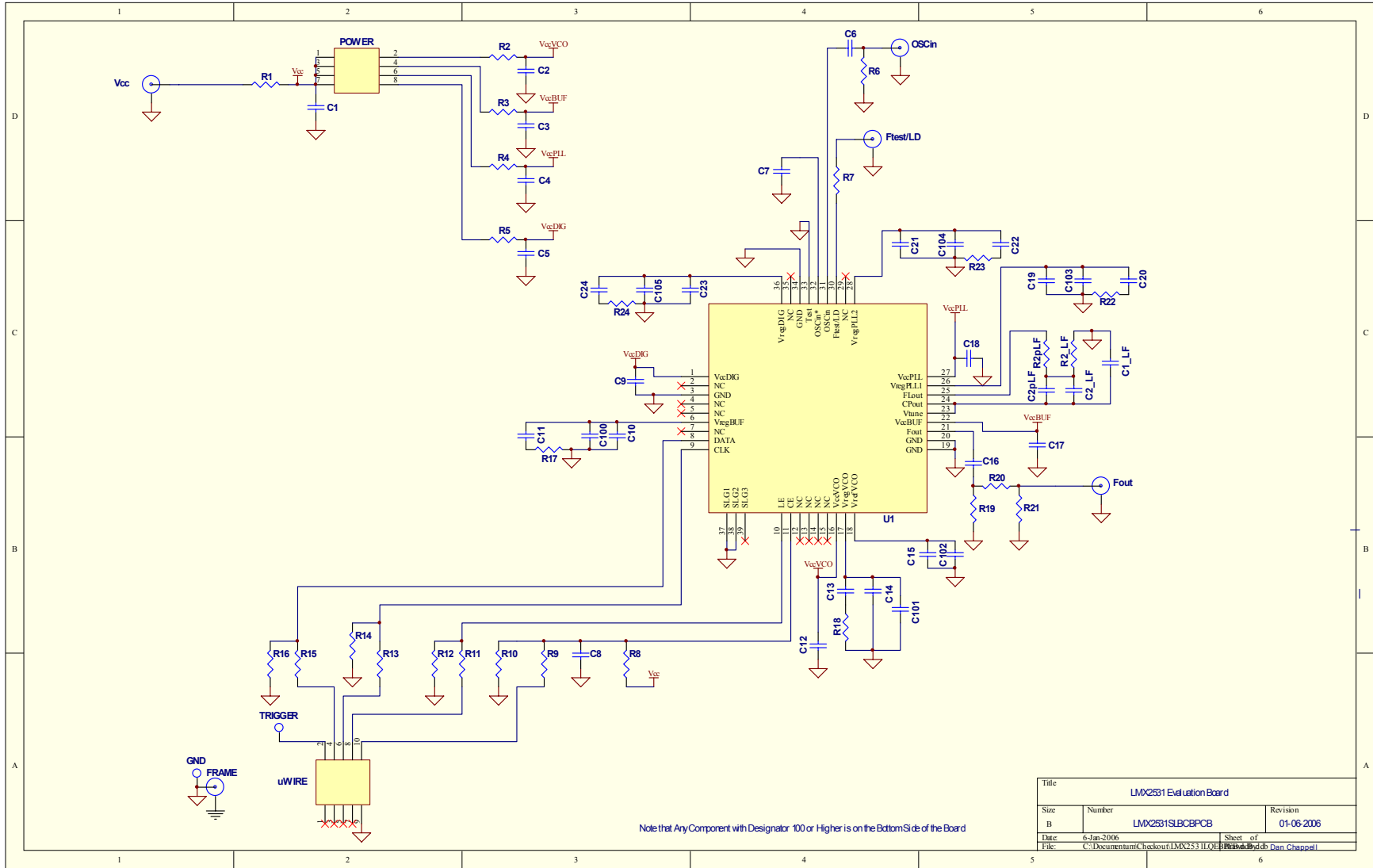

Bill of Materials				LMX2531EB				Revision 1/3/2006	
Item	QTY	Manufacturer	Part #	Size	Tol	Voltage	Material	Value	Designators
0	19	n/a						Open Capacitors	C2pLF, C2, C3, C4, C5, C9, C11, C14, C17, C18, C19, C21, C24, C100, C101, C102, C103, C104, C105
	6							Open Resistors	R7, R8, R17, R19, R21, R24
	1							Open Miscellaneous	Ftest/LD
1	1	Kemet	C0603C470J5GAC	603	5%	50V	C0G	47pF	C1_LF
2	1	Kemet	C0603C101J5GAC	603	5%	50V	C0G	100pF	C16
3	1	Kemet	C0805C272J3GAC	805	5%	25V	C0G	2.7nF	C2_LF
4	2	Kemet	C0603C103J5RAC	603	5%	50V	X7R	10nF	C10, C23
5	4	Kemet	C0603C104J3RAC	603	5%	25V	X7R	100nF	C6, C7, C12, C15
6	2	Kemet	C0603C474K4RAC	603	10%	16V	X7R	470nF	C20, C22
7	1	Kemet	C0603C105K4RAC	603	10%	16V	X5R	1uF	C8
8	1	Kemet	C0603C475K9PAC	603	10%	6.3V	X5R	4.7uF	C13
9	1	Kemet	C0805C106K8PAC	805	10%	10V	X5R	10uF	C1
10	1	Vishay	CRCW0603000ZRT1	603	5%	0.1W	Thick Film	0Ω	R20
11	2	Panasonic	P.22AHCT-ND	603	10%	0.1W	Thick Film	0.22Ω	R22, R23
12	2	Vishay	CRCW06033R3JRT1	603	5%	0.1W	Thick Film	3.3Ω	R1, R18
13	4	Vishay	CRCW0603100JRT1	603	5%	0.1W	Thick Film	10Ω	R2, R3, R4, R5
14	1	Vishay	CRCW0603510JRT1	603	5%	0.1W	Thick Film	51Ω	R6
15	4	Vishay	CRCW0603103JRT1	603	5%	0.1W	Thick Film	10KΩ	R9, R11, R13, R15
16	5	Vishay	CRCW0603123JRT1	603	5%	0.1W	Thick Film	12KΩ	R2pLF, R10, R12, R14, R16
17	1	Vishay	CRCW0603473JRT1	603	5%	0.1W	Thick Film	47KΩ	R2_LF
18	1	Comm Con Connectors	HTSM3203-8G2	2X4	n/a	n/a	Metal/Plastic	Header	POWER
19	1	FCI Electronics	52601-S10-8	2X5	n/a	n/a	Metal/Plastic	Header	uWire
20	3	Johnson Components	142-0701-851	SMA	n/a	n/a	Metal	SMA	Fout, OSCin, Vcc
21	1	National Semiconductor	LMX2531LQEBPCB	n/a	n/a	n/a	FR4 62 mil Thick	PCB Board 1st Layer 10 mils	n/a
22	1	National Semiconductor	LMX2531	LLP36	n/a	2.7	Silicon	LMX2531	U1
23	4	Com Con Connectors	CCIJ255G	2-Pin	n/a	n/a	Metal/Plastic	Shunt	Place Across: POWER: 1-2, 3-4, 5-6, 7-8
24	4	SPC Technology	SPCS-8	0.156"	n/a	n/a	Nylon	Nylon Standoffs	Place in 4 Holes in Corners of Board

Top Layer

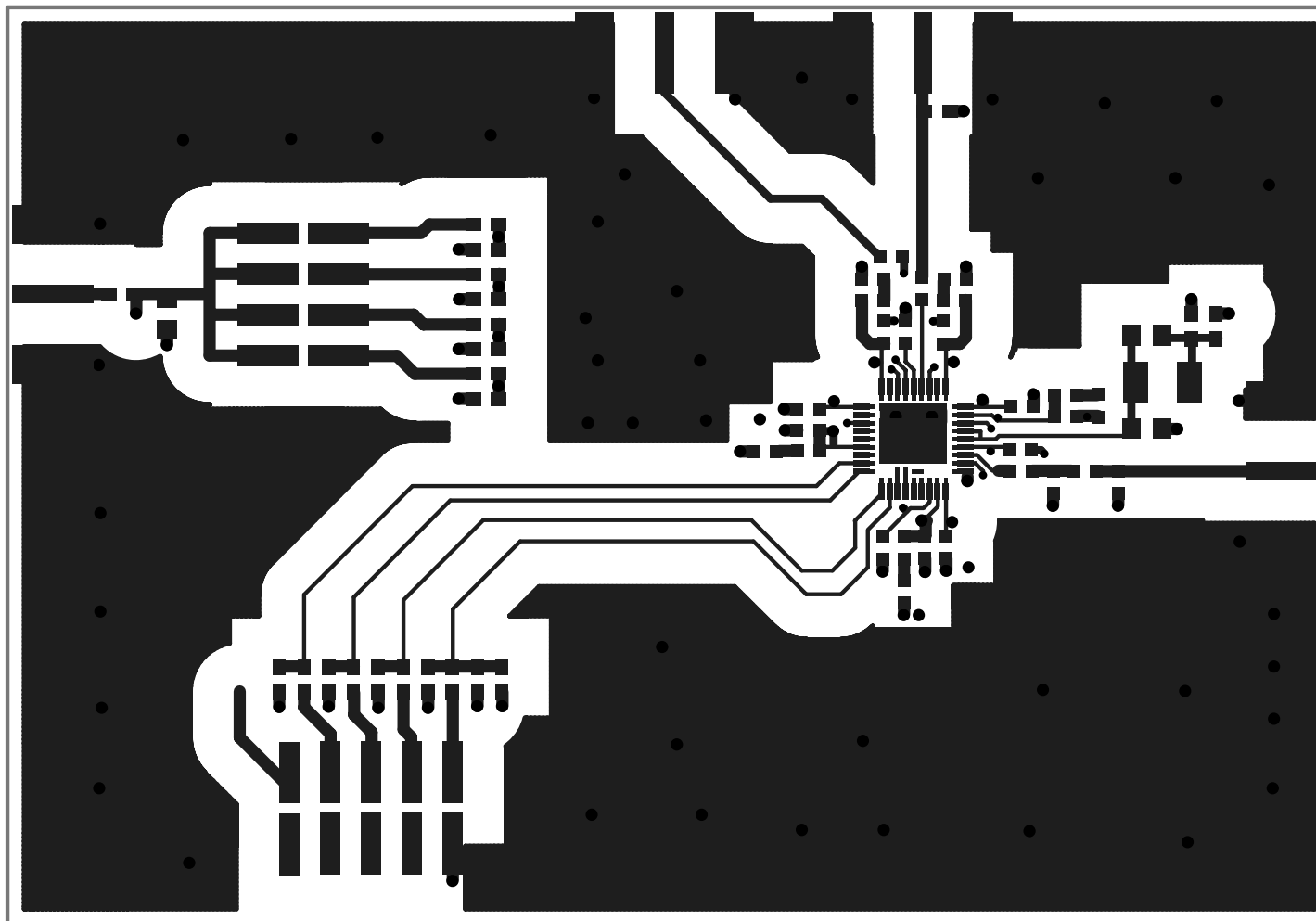

Mid Layer 1 "Ground Plane" (15 Mils Down FR4)

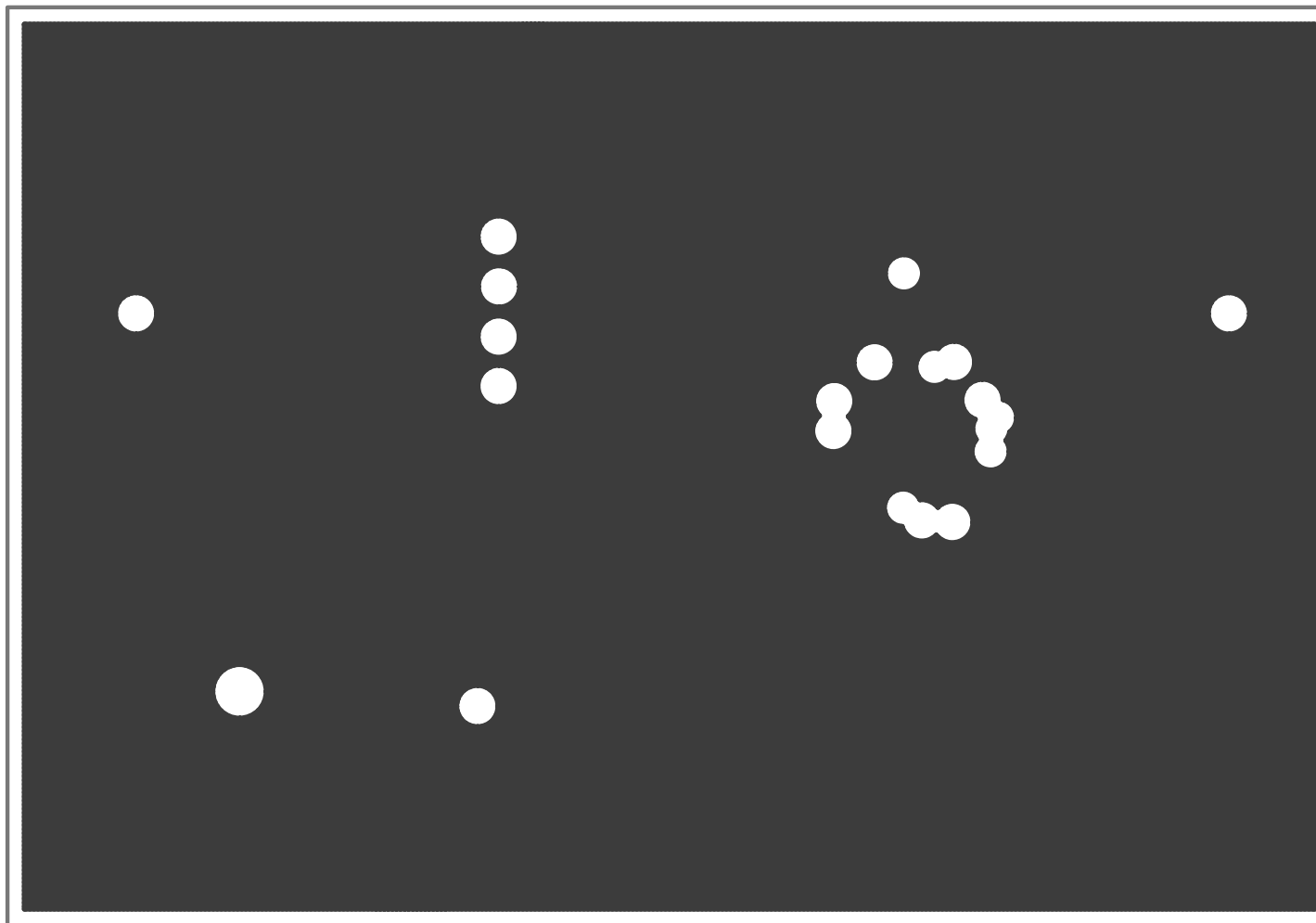

Mid Layer 2 "Power"

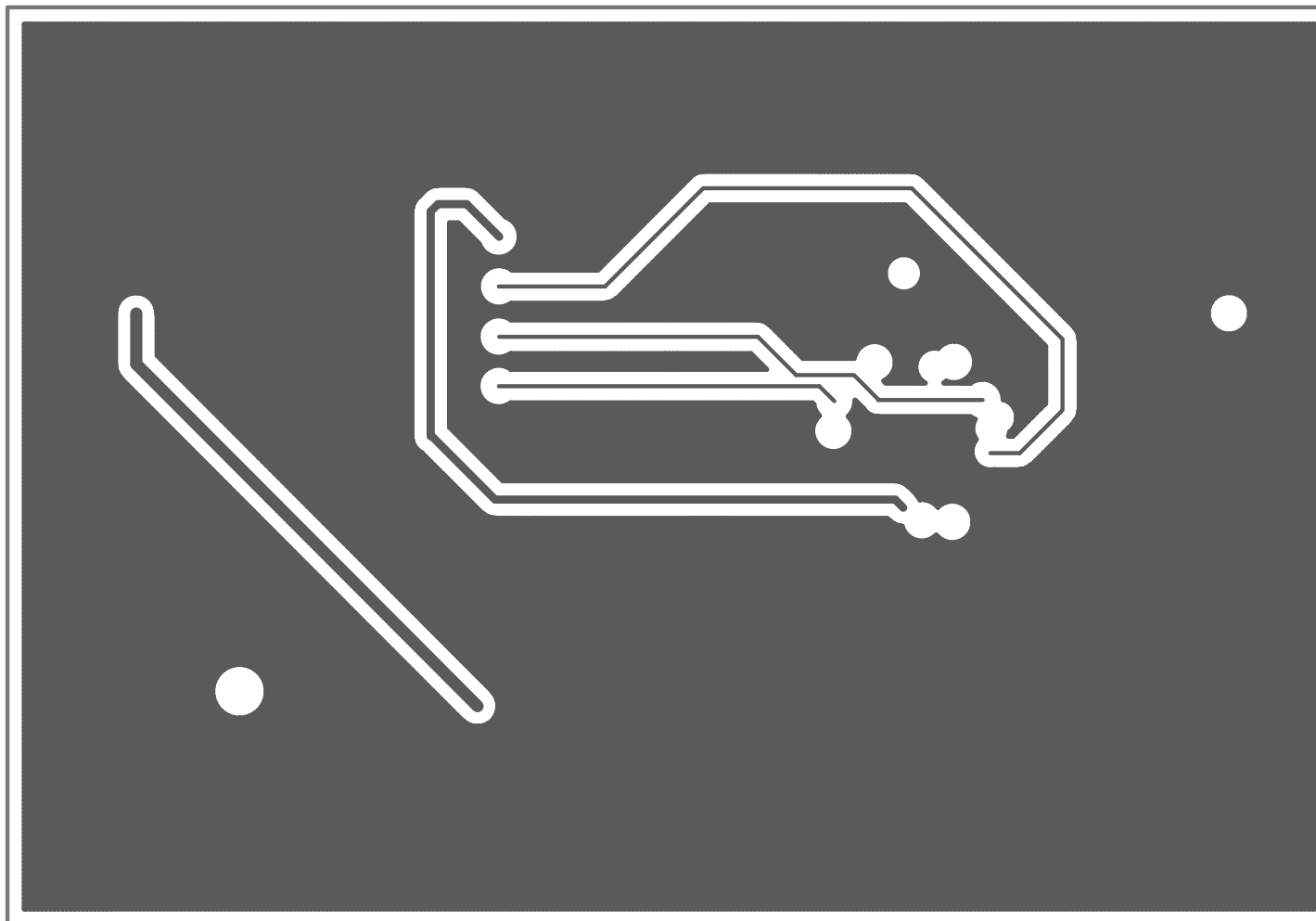

Bottom Layer "Signal"

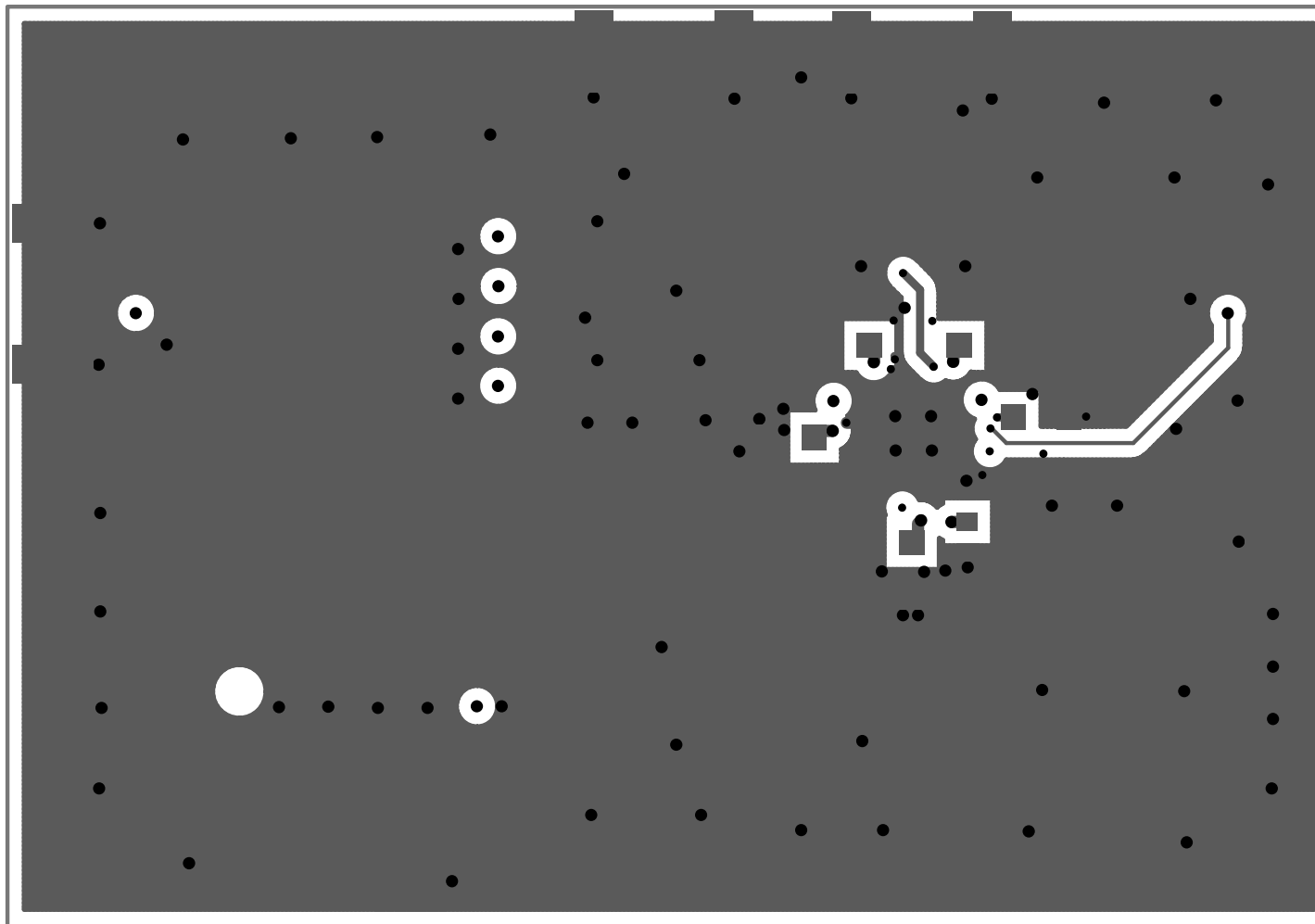

Note: Total Board Thickness = 61 mils

Top Build Diagram

