



User Guide for
FEBFSB127H_T001
Evaluation Board

FSB127H 100kHz Power Switch for
ATX Standby 16W

Featured Fairchild Product:
FSB127H

***Direct questions or comments
about this Evaluation Board to:
“Worldwide Direct Support”***

[Fairchild Semiconductor.com](http://Fairchild.Semiconductor.com)

Table of Contents

1. Overview.....	3
2. Board Configuration	3
3. Schematic.....	4
4. PCB Layout.....	5
5. Test Results.....	6
5.1. Brown-in / Brownout.....	6
5.2. AC Trim Up and Trim Down.....	6
5.3. Line and Load Regulation	6
5.4. DC Output Rise Time.....	7
5.5. DC Transient Response	8
5.6. Ripple and Noise	8
5.7. Capacitive Load.....	9
5.8. Power Saving.....	10
5.9. Efficiency	10
5.10. Short-Circuit Protection	11
5.11. X-Cap Discharge	11
5.12. Over-Power Protection	12
5.13. Surge and ESD	12
5.14. EMI Conduction.....	12
6. Bill of Materials	13
7. Transformer.....	14
7.1. Transformer Specification.....	14
8. Revision History	15

This user guide supports the 16W evaluation board for ATX standby using FSB127H. It should be used in conjunction with the FSB127H datasheet as well as Fairchild's application notes and technical support team. Please visit Fairchild's website at www.fairchildsemi.com.

1. Overview

The highly integrated FSB-series consists of an integrated Current Mode Pulse Width Modulator (PWM) and an avalanche-rugged 700V SenseFET. It is specifically designed for high-performance offline Switch Mode Power Supplies (SMPS) with minimal external components.

Compared with a discrete MOSFET and controller or RCC switching converter solution, the FSB-series reduces total component count, design size, and weight while increasing efficiency, productivity, and system reliability. These devices provide a basic platform for the design of cost-effective flyback converters, as in PC auxiliary power supplies.

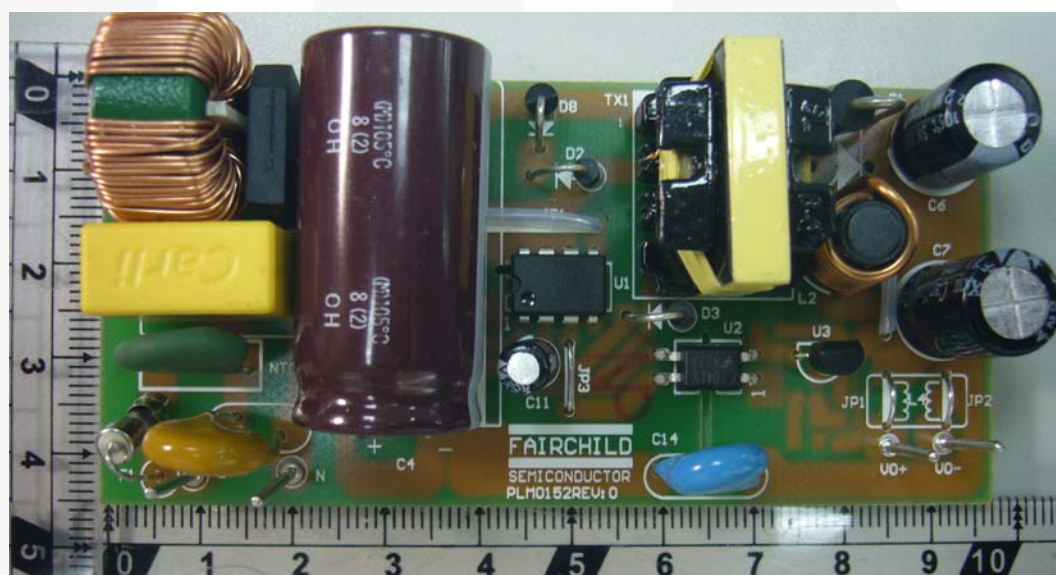

Figure 1. Photo of FEBFSB127H_T001

2. Board Configuration

- Input Voltage: $90V_{AC} - 264V_{AC}$
- Output Voltage: 5V
- Output Current: 0 – 3.2A
- Operation Frequency: 100kHz

3. Schematic

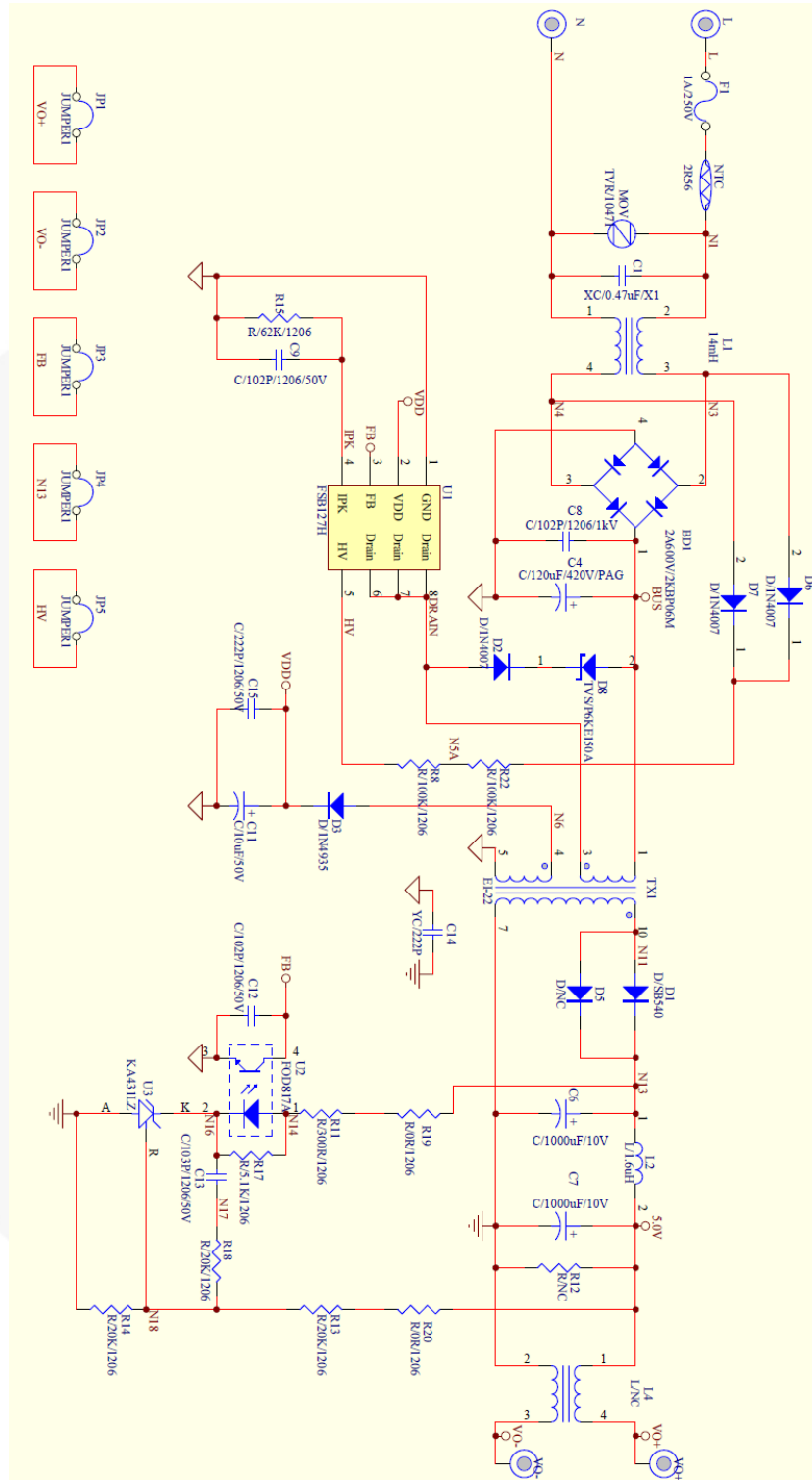

Figure 2. Evaluation Board Schematic

4. PCB Layout

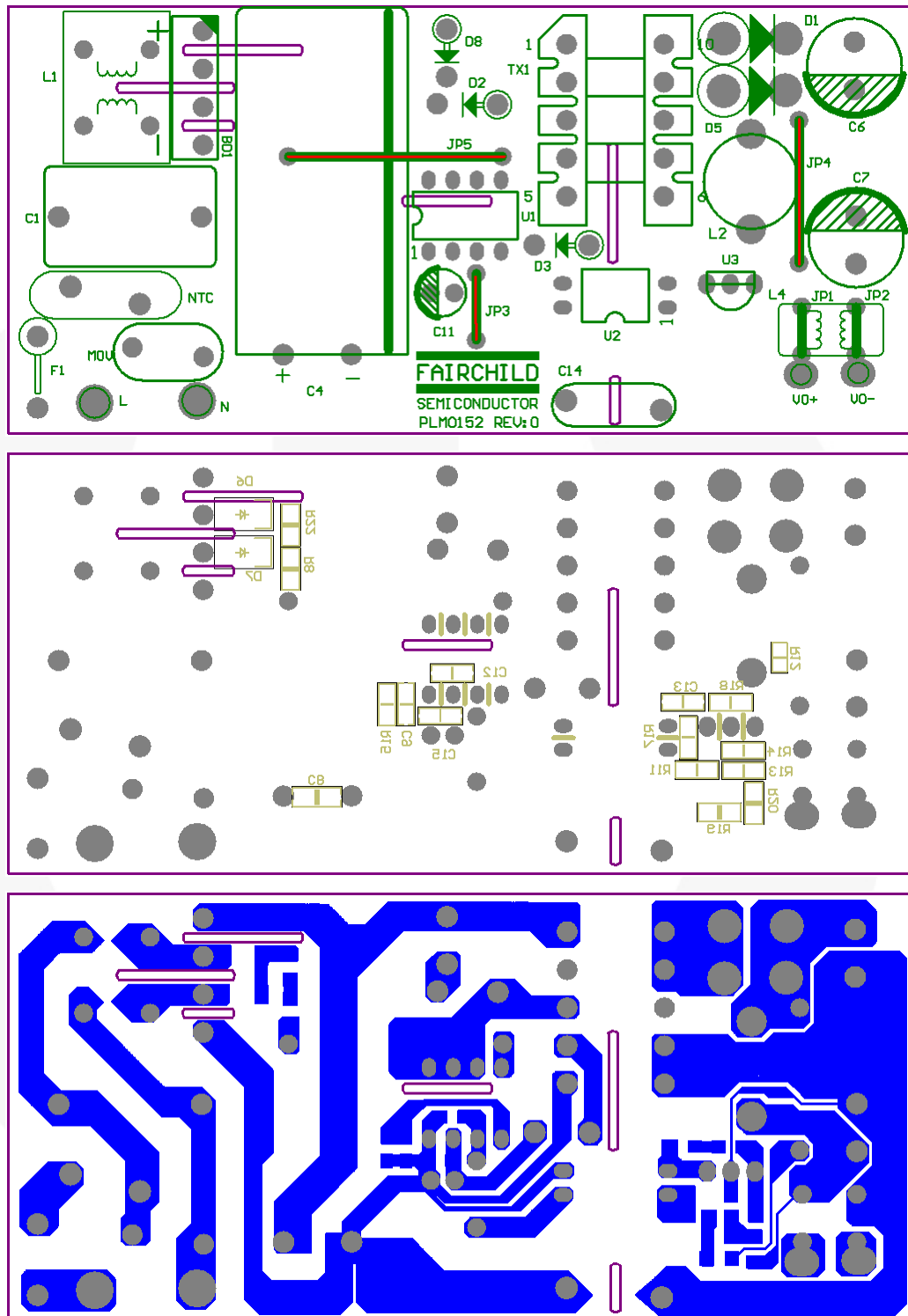

Figure 3. Evaluation Board PCB Layout

5. Test Results

5.1. Brown-in / Brownout

5.1.1. Test Condition

Decrease input AC voltage gradually and measure the turn-off threshold.

After DC power off, increase input voltage and measure the recovery threshold.

5.1.2. Test Result

R_{HV}=200kΩ	Minimum Load	Maximum Load
Turn off	70 V _{AC}	68 V _{AC}
Turn on	81 V _{AC}	81 V _{AC}

5.2. AC Trim Up and Trim Down

5.2.1. Test Condition

Switch the input voltage from 90V to 264V or from 264V to 90V; the output voltages should be normal.

5.2.2. Test Result

	Minimum Load	Maximum Load
90V→264V	Pass	Pass
264V →90V	Pass	Pass

5.3. Line and Load Regulation

5.3.1. Test Condition

Line regulation: 1% maximum.

Load regulation: 5% maximum.

5.3.2. Test Result

Input Voltage	Max. Load	Min. Load	Load Regulation (%)
90V / 60Hz	4.971V	5.013V	0.84%
264V / 50Hz	4.988V	5.013V	
Line Regulation (%)	0.34%	0%	

5.4. DC Output Rise Time

5.4.1. Test Condition

Load: maximum load and minimum load. DC-output rise time: 20ms, maximum.

5.4.2. Measured Waveforms

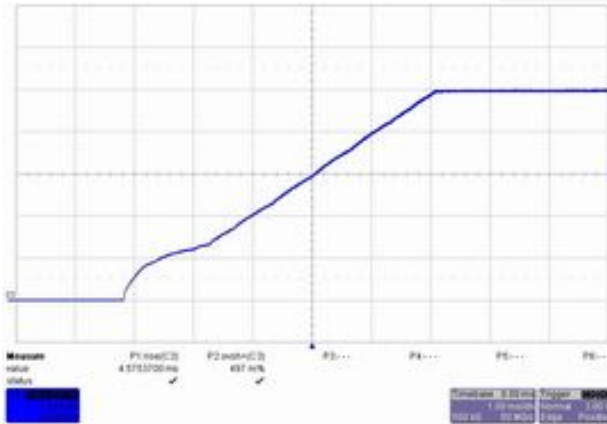

Figure 4. 90V / 60Hz Maximum Load

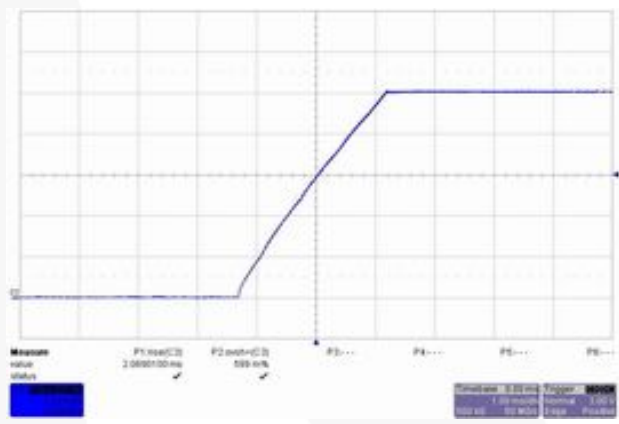

Figure 5. 90V / 60Hz Minimum Load

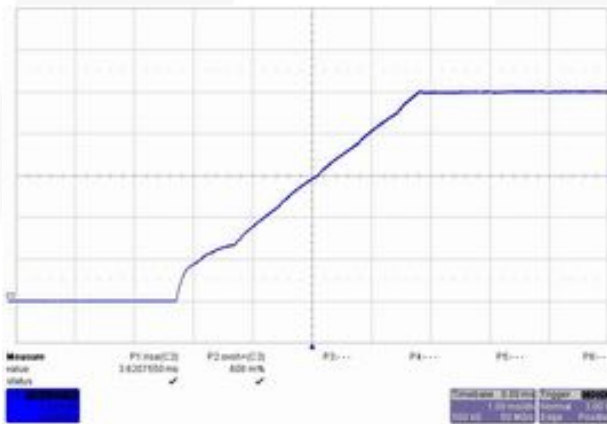

Figure 6. 264V / 50Hz Maximum Load

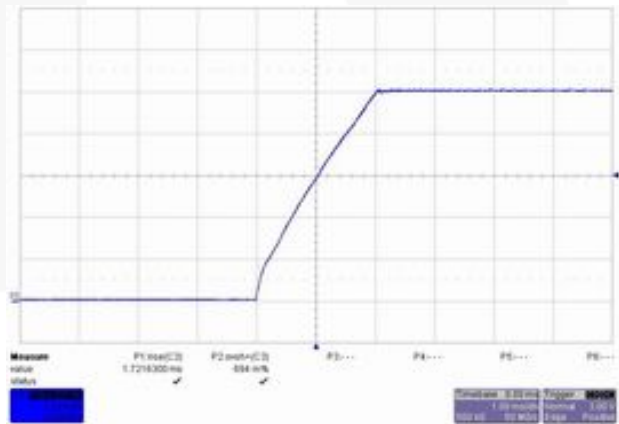

Figure 7. 264V / 50Hz Minimum Load

5.5. DC Transient Response

5.5.1. Test Condition

From 10–90% of maximum and minimum load, with a $2.5A/\mu s$ slew rate; 5ms/5ms.

5.5.2. Measured Waveforms

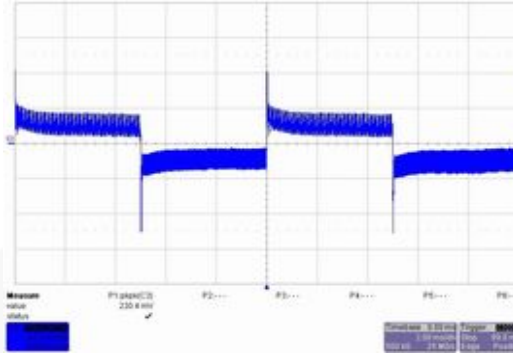

Figure 8. 90V_{AC} / 60Hz

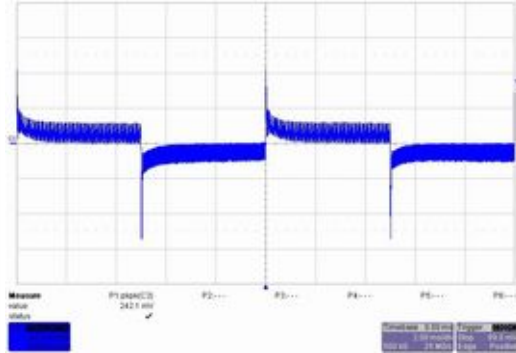

Figure 9. 264V_{AC} / 50Hz

5.6. Ripple and Noise

5.6.1. Test Condition

Tested by DC loading side parallel with a $10\mu F/EC$ and $0.1\mu F/CC$ capacitor and measured bandwidth with DC-20MHz.

5.6.2. Measured Waveforms

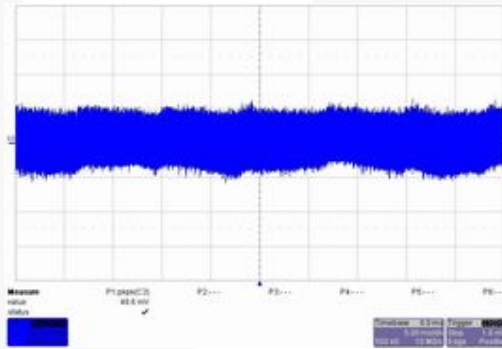

Figure 10. 90V / 60Hz Maximum Load

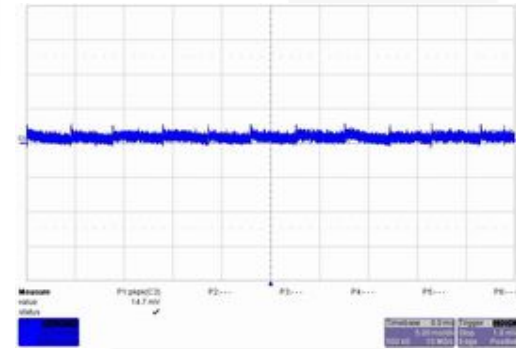

Figure 11. 90V / 60Hz Minimum Load

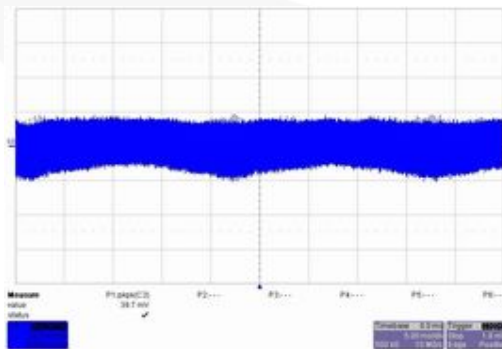

Figure 12. 264V / 50Hz Maximum Load

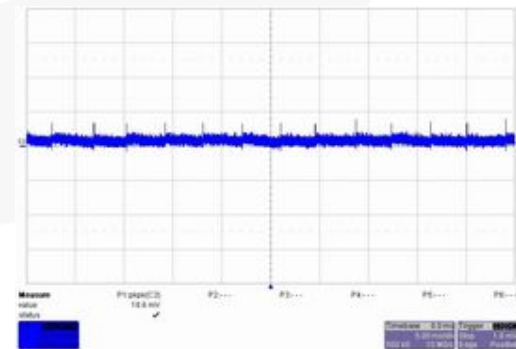

Figure 13. 264V / 50Hz Minimum Load

5.7. Capacitive Load

5.7.1. Test Condition

Output Capacitive Load = 12000 μ F

5.7.2. Measured Waveforms

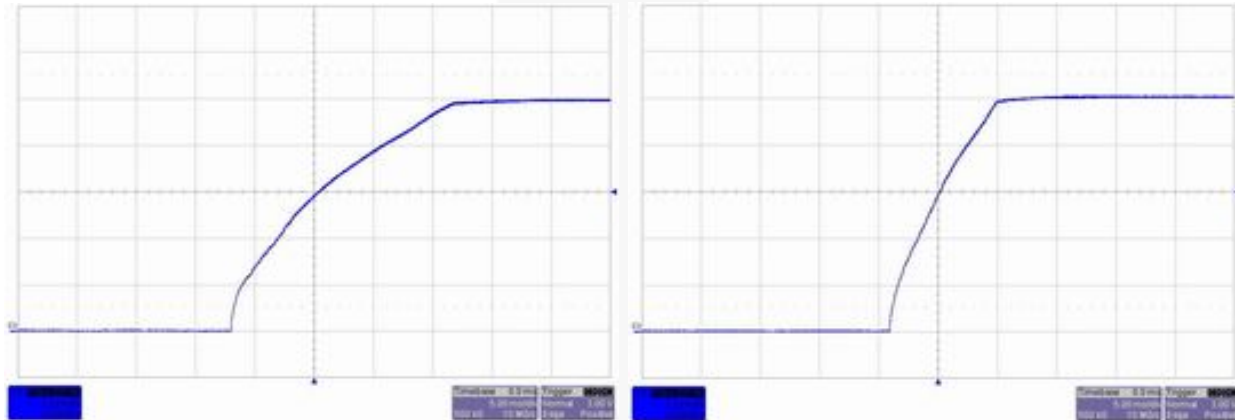

90V / 60Hz Maximum Load

90V / 60Hz Minimum Load

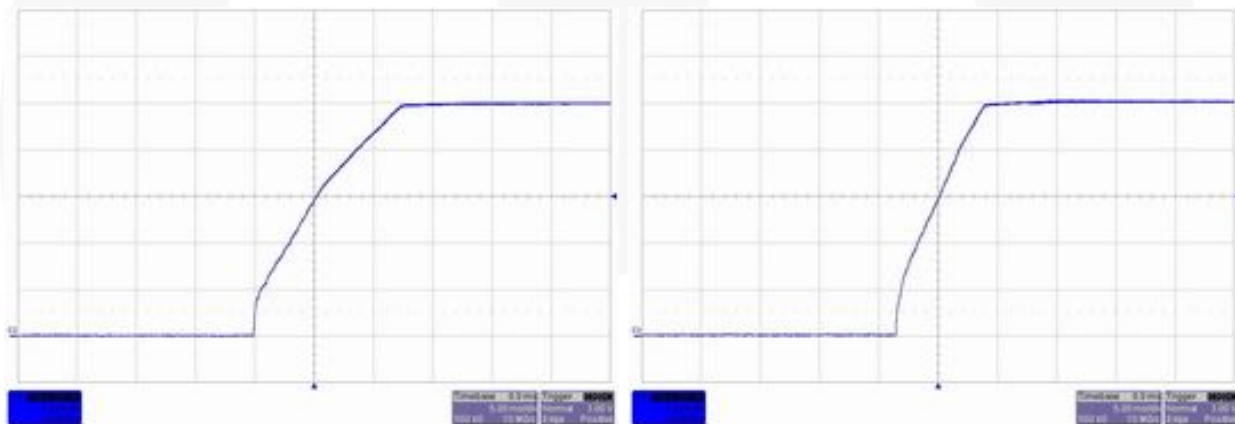

264V / 50Hz Maximum Load

264V / 50Hz Minimum Load

5.8. Power Saving

5.8.1. Test Condition

The input wattage is < 1W in Standby Mode with 0.5W loading for 2010 EuP.

The input wattage is < 0.5W in Standby Mode with 0.25W loading for 2013 EuP.

5.8.2. Test Result

FSB127H		Input Watts	Output Watts
A.	When V_{IN} = 230V _{AC} , with 0.5W Loading	0.713W	0.5W
	When V_{IN} = 240V _{AC} , with 0.5W Loading	0.715W	0.5W
	When V_{IN} = 264V _{AC} , with 0.5W Loading	0.733W	0.5W
B.	When V_{IN} = 230V _{AC} , with 0.25W Loading	0.384W	0.25W
	When V_{IN} = 240V _{AC} , with 0.25W Loading	0.389W	0.25W
	When V_{IN} = 264V _{AC} , with 0.25W Loading	0.406W	0.25W
C.	When V_{IN} = 230V _{AC} , with No Loading	53mW	x
	When V_{IN} = 240V _{AC} , with No Loading	56mW	x
	When V_{IN} = 264V _{AC} , with No Loading	68mW	x

5.9. Efficiency

5.9.1. Test Condition

Measure efficiency at minimum, mid-point, and maximum loading.

5.9.2. Test Result

FSB127H	Input Watts	Output Watts	Efficiency
When V_{IN} = 115V, at 100% Load	20.62W	16W	81.17%
When V_{IN} = 115V, at 75% Load	15.28W	12W	82.42%
When V_{IN} = 115V, at 50% Load	10.02W	8W	82.51%
When V_{IN} = 115V, at 25% Load	5.07W	4W	81.70%
When V_{IN} = 230V, at 100% Load	20.78W	16W	81.40%
When V_{IN} = 230V, at 75% Load	15.11W	12W	82.24%
When V_{IN} = 230V, at 50% Load	10.15W	8W	80.45%
When V_{IN} = 230V, at 25% Load	5.18W	4W	78.62%

5.10. Short-Circuit Protection

5.10.1. Test Condition

In the event of a short circuit on any DC output, the power supply should be protected from damage.

5.10.2. Test Result

	90V / 60Hz	264V / 50Hz
Minimum Load	PASS	PASS
Maximum Load	PASS	PASS

5.10.3. Measured Waveforms

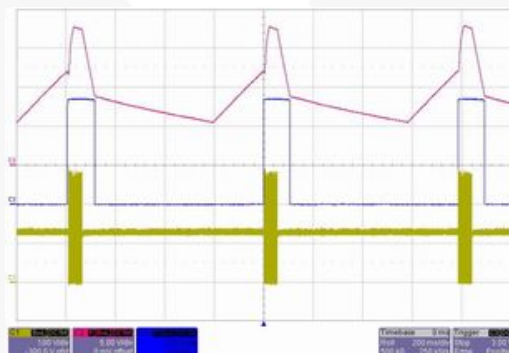

Figure 14. 90V_{AC}/60Hz, Output Short
(Ch1: Drain, Ch2: V_{DD}, Ch3: FB)

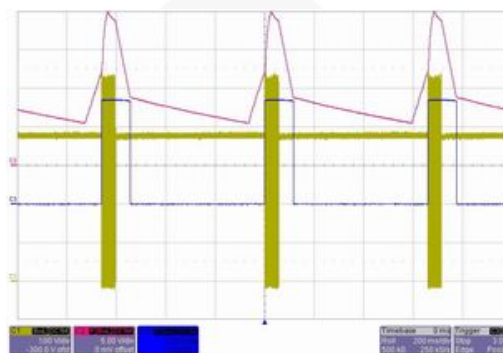

Figure 15. 264V_{AC}/50Hz Output Short
(Ch1: Drain, Ch2: V_{DD}, Ch3: FB)

5.11. X-Cap Discharge

5.11.1. Test Condition

The voltage will have decayed to 37% of its original value in one second after the AC input plug is disconnected.

5.11.2. Measured Waveforms

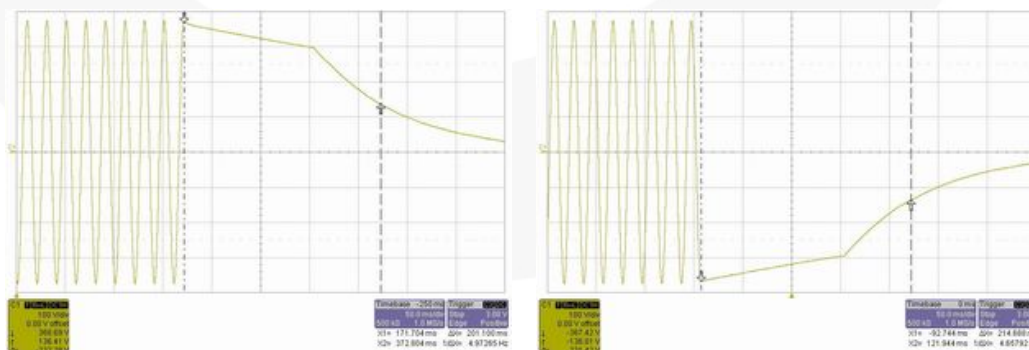

Figure 16. 264V_{AC}/50Hz, No Load, X-Cap=0.47μF, R_{HV}=200kΩ

5.12. Over-Power Protection

5.12.1. Test Condition

An over-current from the output return line does not damage the power supply and the OLP protection is enabled.

5.12.2. Test Result

Input Voltage	90V	115V	132V	180V	230V	264V
OPP (W)	24.10W	25.43W	26.42W	26.37W	26.04W	26.12W

5.13. Surge and ESD

5.13.1. Test Result

L-PE ±6KV	N-PE ±6KV	L-N ±1KV	AIR ±16KV	Contact ±8KV
Pass	Pass	Pass	Pass	Pass

5.14. EMI Conduction

5.14.1. Measured Waveforms

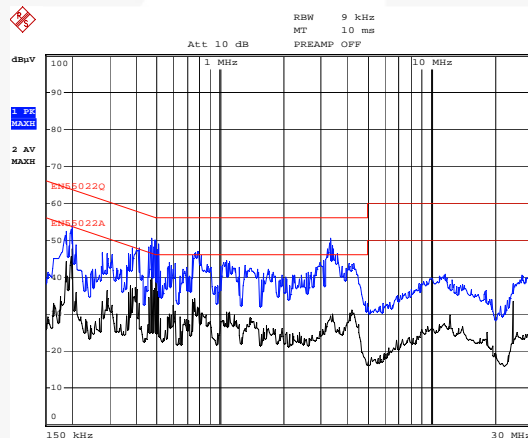

Figure 17. L: 115 / 60Hz

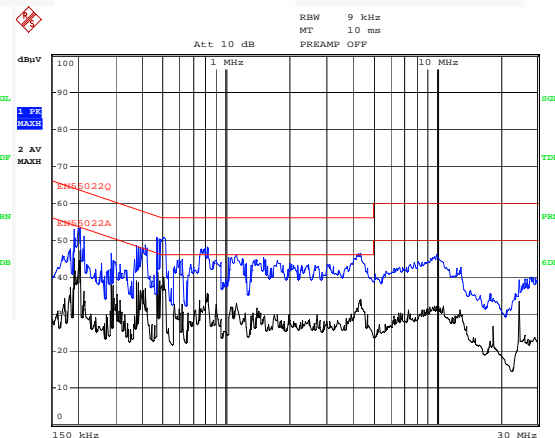

Figure 18. N: 115 / 60Hz

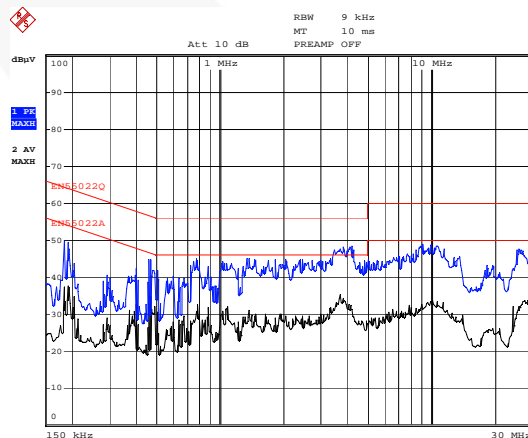

Figure 19. L: 230 / 50Hz

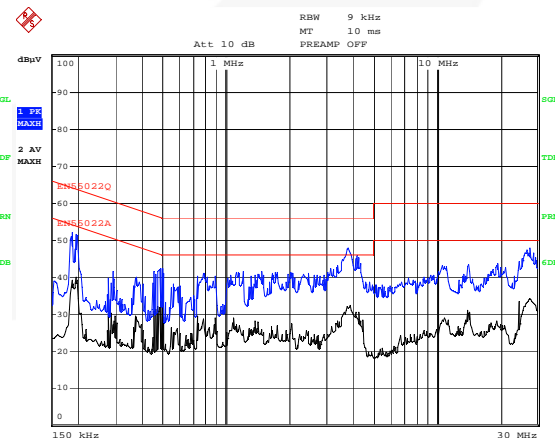

Figure 20. N: 230 / 50Hz

6. Bill of Materials

Component	Qty	Part No.	Manufacturer	Reference
JUMPER WIRE 0.8Ø (mm)	5			JP1, JP2, JP3, JP4, JP5
Resistor 1206 0Ω ±5%	2			R19, R20
Resistor 1206 100KΩ ±5%	2			R8, R22
Resistor 1206 20KΩ ±1%	3			R13, R14, R18
Resistor 1206 300Ω ±5%	1			R11
Resistor 1206 5K1Ω ±5%	1			R17
Resistor 1206 62KΩ ±1%	1			R15
NTC 13Ø 2ΩSCK132	1			NTC
1206 MLCC X7R 102P 50V ±10%	2			C9, C12
1206 MLCC X7R 102P 1KV ±10%	1			C8
1206 MLCC X7R 103P 50V ±10%	1			C13
1206 MLCC X7R 222P 50V ±10%	1			C15
Electrolytic Capacitor 10μ 50V 105°C	1	LHK	JACKCON	C11
Electrolytic Capacitor 120μ 420V 105°C	1	LHK	PAG	C4
Electrolytic Capacitor 1000μ 10V 105°C	2	LHK	SAMXON	C6, C7
X2 Capacitor 0.47μ 275V ±20%	1			C1
Y1 Capacitor 222P 250V ±20%	1			C14
Inductor 14mH	1	TRN0183	SEN HUEI	L1
Inductor 2.5μH	1	TRN0204	SEN HUEI	L2
Transformer EI-22 900μH	1	TRN0317	SEN HUEI	TX1
Schottky Diode 5A/40V	1	SB540	FAIRCHILD	D1
Fast Diode 1A/1000V	1	1N4007	FAIRCHILD	D2
Fast Diode 1A/200V	1	1N4935	FAIRCHILD	D3
SMD Fast Diode 1A/1000V	2	S1M	FAIRCHILD	D6, D7
Bridge 2A/800V	1	2KBP08M	FAIRCHILD	BD1
REGULATOR KA431L ±0.5%	1		FAIRCHILD	U3
IC FOD817A DIP	1		FAIRCHILD	U2
FUSE CERAMIC 250V1A 3.6*10mm	1	SLOW 37SG	SLEEK	F1
Varistor 7μ470V	1			MOV
TVS Breakdown Voltage 143V–158V	1	P6KE150A	FAIRCHILD	D8
Test Pin SG004-05	4			L N VO+ VO-
PCB PLM0152 REV0	1		FAIRCHILD	
FSB127HNY	1		FAIRCHILD	U1

7. Transformer

7.1. Transformer Specification

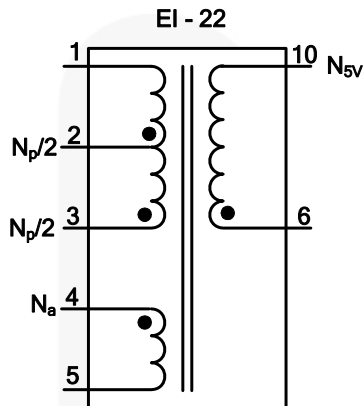

Core: EI-22 ($A_e=37.5\text{mm}^2$)
Bobbin: EI-22

Figure 21. Transformer Specification

Table 1. Winding Specifications

	Pins (S → F)	Wire	Turns	Winding Method
$N_p/2$	3 → 2	0.27 ϕ ×1	31	Solenoid Winding
Insulation: Polyester Tape t = 0.025mm, 3 Layer				
N_{sv}	6 → 10	0.55 ϕ ×2	5	Solenoid Winding
Insulation: Polyester Tape t = 0.025mm, 3 Layers				
$N_p/2$	2 → 1	0.27 ϕ ×1	31	Solenoid Winding
Insulation: Polyester Tape t = 0.025mm, 6 Layers				
N_a	4 → 5	0.15 ϕ ×1	12	Solenoid Winding
Insulation: Polyester Tape t = 0.025mm, 3 Layers				

Table 2. Specifications

	Pins	Specifications	Remark
Primary-Side Inductance	1 - 3	900 μ H \pm 10%	100kHz, 1V
Primary-Side Effective Leakage	1 - 3	< 30 Ω H Max.	Short All Other Pins

8. Revision History

Rev.	Date	Description
0.0.1	11/10/11	Initial release

WARNING AND DISCLAIMER

Replace components on the Evaluation Board only with those parts shown on the parts list (or Bill of Materials) in the Users' Guide. Contact an authorized Fairchild representative with any questions.

This board is intended to be used by certified professionals, in a lab environment, following proper safety procedures. Use at your own risk. The Evaluation board (or kit) is for demonstration purposes only and neither the Board nor this User's Guide constitute a sales contract or create any kind of warranty, whether express or implied, as to the applications or products involved. Fairchild warrants that its products meet Fairchild's published specifications, but does not guarantee that its products work in any specific application. Fairchild reserves the right to make changes without notice to any products described herein to improve reliability, function, or design. Either the applicable sales contract signed by Fairchild and Buyer or, if no contract exists, Fairchild's standard Terms and Conditions on the back of Fairchild invoices, govern the terms of sale of the products described herein.

DISCLAIMER

FAIRCHILD SEMICONDUCTOR RESERVES THE RIGHT TO MAKE CHANGES WITHOUT FURTHER NOTICE TO ANY PRODUCTS HEREIN TO IMPROVE RELIABILITY, FUNCTION, OR DESIGN. FAIRCHILD DOES NOT ASSUME ANY LIABILITY ARISING OUT OF THE APPLICATION OR USE OF ANY PRODUCT OR CIRCUIT DESCRIBED HEREIN; NEITHER DOES IT CONVEY ANY LICENSE UNDER ITS PATENT RIGHTS, NOR THE RIGHTS OF OTHERS.

LIFE SUPPORT POLICY

FAIRCHILD'S PRODUCTS ARE NOT AUTHORIZED FOR USE AS CRITICAL COMPONENTS IN LIFE SUPPORT DEVICES OR SYSTEMS WITHOUT THE EXPRESS WRITTEN APPROVAL OF THE PRESIDENT OF FAIRCHILD SEMICONDUCTOR CORPORATION.

As used herein:

1. Life support devices or systems are devices or systems which, (a) are intended for surgical implant into the body, or (b) support or sustain life, or (c) whose failure to perform when properly used in accordance with instructions for use provided in the labeling, can be reasonably expected to result in significant injury to the user.
2. A critical component is any component of a life support device or system whose failure to perform can be reasonably expected to cause the failure of the life support device or system, or to affect its safety or effectiveness.

ANTI-COUNTERFEITING POLICY

Fairchild Semiconductor Corporation's Anti-Counterfeiting Policy. Fairchild's Anti-Counterfeiting Policy is also stated on our external website, www.fairchildsemi.com, under Sales Support.

Counterfeiting of semiconductor parts is a growing problem in the industry. All manufacturers of semiconductor products are experiencing counterfeiting of their parts. Customers who inadvertently purchase counterfeit parts experience many problems such as loss of brand reputation, substandard performance, failed applications, and increased cost of production and manufacturing delays. Fairchild is taking strong measures to protect ourselves and our customers from the proliferation of counterfeit parts. Fairchild strongly encourages customers to purchase Fairchild parts either directly from Fairchild or from Authorized Fairchild Distributors who are listed by country on our web page cited above. Products customers buy either from Fairchild directly or from Authorized Fairchild Distributors are genuine parts, have full traceability, meet Fairchild's quality standards for handling and storage and provide access to Fairchild's full range of up-to-date technical and product information. Fairchild and our Authorized Distributors will stand behind all warranties and will appropriately address any warranty issues that may arise. Fairchild will not provide any warranty coverage or other assistance for parts bought from Unauthorized Sources. Fairchild is committed to combat this global problem and encourage our customers to do their part in stopping this practice by buying direct or from authorized distributors.

EXPORT COMPLIANCE STATEMENT

These commodities, technology, or software were exported from the United States in accordance with the Export Administration Regulations for the ultimate destination listed on the commercial invoice. Diversion contrary to U.S. law is prohibited.

U.S. origin products and products made with U.S. origin technology are subject to U.S. Re-export laws. In the event of re-export, the user will be responsible to ensure the appropriate U.S. export regulations are followed.