

Low Voltage, High Current, LED Driver Demoboard

General Description

The HV9910BDB3 demoboard is a high current LED driver designed to drive one LED or two LEDs in series at currents up to 1.0A from a 10 – 30V DC input. The demoboard uses Supertex’s HV9910B Universal LED driver IC to drive a buck converter.

The HV9910BDB3 can be configured to operate in either a constant frequency mode (for driving a single LED) or in a constant off-time mode (for driving two LEDs).

The output current can be adjusted in two ways – either with linear dimming using the onboard potentiometer or with PWM dimming by applying a TTL – compatible square wave signal at the PWMD terminal. Using linear dimming, the output current of the HV9910DB1 can be lowered to about 0.01A (note: zero output current can be obtained only by PWM dimming).

Specifications

Parameter	Value
Input voltage	10 - 30VDC
Output voltage - constant frequency mode	2.0 - 4.5V
Output voltage - constant off-time mode	4.0 - 8.0V
Maximum output current	1.0A ± 10%
Output current ripple (typ)	20% (peak-peak)
Efficiency (@ 12V input)	86% (for one LED)
	93% (for two LEDs)
Open LED protection	yes
Output short circuit protection	no
Dimensions	48.2mm X 29.0mm

Connection Diagram

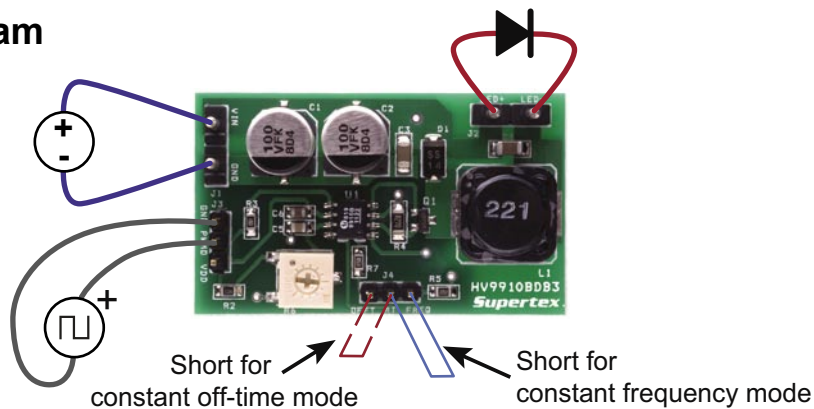

Connections

- Input Connection:** Connect the input DC voltage between **VIN** and **GND** terminals of connector J1 as shown in the connection diagram.
- Output Connection:** Connect the LEDs between **LED+** (anode of LED string) and **LED-** (cathode of LED string) of connector J2.
 - If the load is one LED, short the **RT** and **FREQ** terminals of connector J4 using a jumper.
 - If the load is two LEDs, short the **RT** and **OFFT** terminals of connector J4 using a jumper.
- PWM Dimming Connection:**
 - If no PWM dimming is required, short **PWMD** and **VDD** terminals of connector J3.
 - If PWM dimming is required, connect the TTL-compatible PWM source between **PWMD** and **GND** terminals of connector J3. The recommended PWM dimming frequency is $\leq 1.0\text{kHz}$.

Frequently Asked Questions

1. Why does the demoboard have two operating modes?

Constant frequency mode limits the maximum output voltage to less than 50% of the minimum input voltage. So, in this case, if we use only the constant frequency mode, the maximum output voltage will have to be less than 5V. Constant off-time mode removes this limitation and allows the output voltage become higher. However, in order to achieve reasonable noise immunity and to limit the switching frequency variation over the input voltage range, it is not recommended to operate the HV9910DB3 with the output voltage exceeding 80% of the input voltage, even in the constant off-time mode. Please refer to application note AN-H50 on the Supertex website for more details.

2. If the minimum input voltage in my application is higher (say 20V), does that mean I can drive a 9V LED string in the constant frequency mode or an 16V LED string in the constant off-time mode using the demoboard?

Although a larger LED string can be driven using the demoboard in these conditions, the demoboard will not be able to drive the LED at 1A.

The HV9910B is a constant peak current controller. The average LED current is equal to the peak current set (using the sense resistor) minus one-half of the ripple current in the inductor.

Higher output voltages lead to larger ripple current values, which will reduce the maximum LED current the board can deliver.

3. How can I compute the maximum LED current the demoboard can deliver if I use a higher input voltage and a higher LED string voltage?

Parameters	Minimum input voltage	= $V_{IN,MIN}$	
	Maximum LED string voltage	= $V_{O,MAX}$	
	Switching frequency (constant frequency mode)	= f_s	(100kHz)
	Off-Time (constant off-time mode)	= T_{OFF}	(5.1µs)
	HV9910B CS threshold voltage	= V_{CS}	(0.25V)
	Sense Resistor	= R_{CS}	(0.22Ω)
	Inductor	= L	(220µH)
Constant Off-Time Mode		Constant Frequency Mode	
$\Delta I = \frac{V_{O,MAX} \cdot T_{OFF}}{L}$ $I_{LED} = \frac{V_{CS}}{R_{CS}} - \frac{\Delta I}{2}$ $\text{Maximum Switching Frequency} = \frac{\left\{ 1 - \frac{V_{O,MAX}}{V_{IN,MIN}} \right\}}{T_{OFF}}$		$\Delta I = \frac{V_{O,MAX} \cdot \left\{ 1 - \frac{V_{O,MAX}}{V_{IN,MIN}} \right\}}{L \cdot f_s}$ $I_{LED} = \frac{V_{CS}}{R_{CS}} - \frac{\Delta I}{2}$	

Frequently Asked Questions (cont.)

4. If the constant off-time mode allows a wider LED voltage range, why not use that mode exclusively? Why do we need the constant frequency mode?

Although the constant off-time mode allows the demoboard to operate at a higher output voltage, the LED ripple current is directly proportional to the output voltage in this mode. This makes it difficult to get a good load regulation of the LED current in the constant off-time mode with a wide variation in the LED string voltage (in this case it will be a 1:4 variation). At lower LED voltage values, the ripple will be lower and the LED current would be higher.

By switching between the two modes depending on the load, we can get a better current accuracy without having to adjust the LD voltage or the sense resistor.

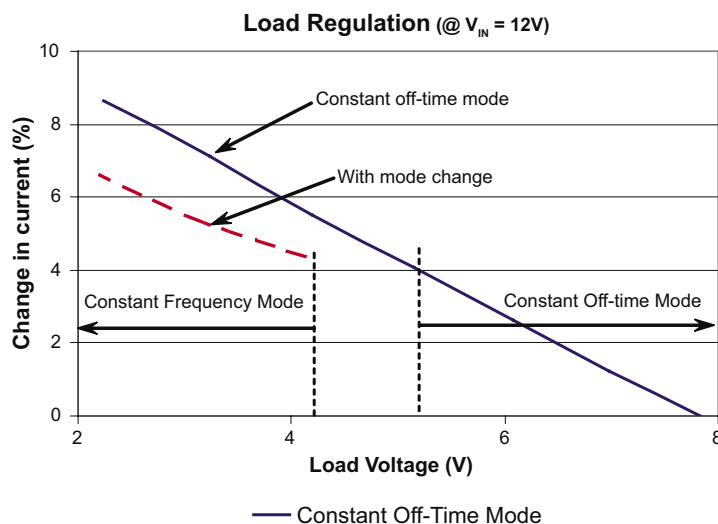

5. Why is the efficiency of the demoboard higher with a load of two LEDs compared to a single LED load?

Losses in the HV9910BDB3 occur due mainly due to two factors:

- a. Conduction losses in the FET and diode
- b. Switching losses in the FET

Switching losses are dependent on the switching frequency, input voltage and total parasitic capacitance at the node. At higher switching frequencies, the switching losses are higher.

Conduction losses are dependent on the duty cycle. Since the voltage drop on the FET is smaller than the voltage drop on the diode (the on-resistance of the FET is very small), the higher the duty cycle, the smaller is the conduction loss. Please note that we are ignoring the losses in the inductor, which will be identical in both cases.

Also, efficiency = $P_{OUT} / P_{IN} = P_{OUT} / (P_{OUT} + \text{losses}) = 1 / (1 + \text{losses} / P_{OUT})$, where P_{OUT} is the output power and P_{IN} is the input power. So, if the output power is higher, the fixed switching losses are a smaller fraction of the output power and thereby the efficiency is higher.

Comparing the operation of the converter in both modes at 12V input for this particular demoboard, the following are the differences:

- a. Output power is higher with 2 LEDs as the load
- b. Switching frequency in the constant off-time mode is 55kHz, whereas it is 100kHz in the constant frequency mode
- c. Duty cycle of operation is about higher in the constant off-time mode by a factor of 2 than in the constant frequency mode

All the above factors favor the higher load voltage and thus the demoboard has a higher efficiency when the load is larger.

Frequently Asked Questions (cont.)

6. Why are the LED current rise and fall times during PWM dimming different when the load changes from one LED to two LEDs?

The LED current rise time is directly proportional to $V_{IN} - V_{OUT}$ and the fall time is proportional to V_{OUT} (where V_{IN} is the input voltage and V_{OUT} is the output voltage). Since V_{OUT} is higher with two LEDs, the rise time will be larger and the fall time will be smaller.

Typical Results

Constant Frequency Mode:

The HV9910BDB3 is designed to be operated in the constant frequency mode when the load is a single LED. In this mode, the line regulation of the LED current is less than 2% and full-load efficiency greater than 80%.

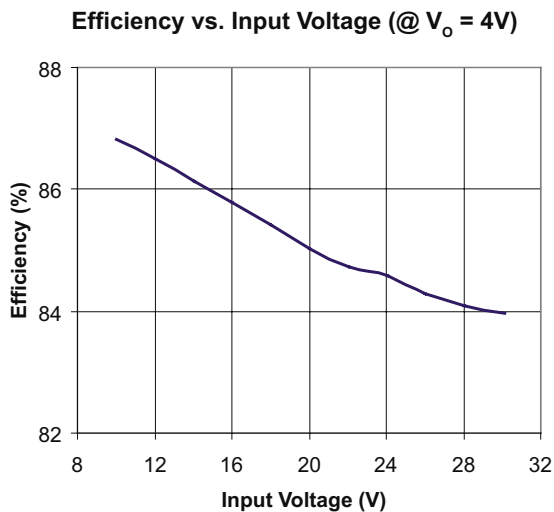

Fig. 1. Efficiency vs. Input Voltage Plot

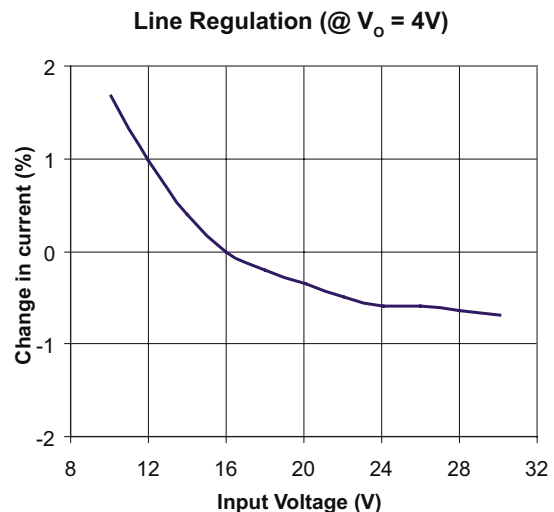

Fig. 2. Line Regulation of LED Current Plot

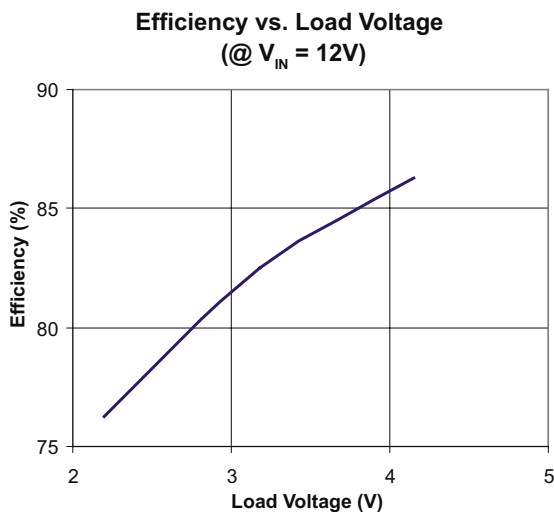

Fig. 3. Efficiency vs. Load Voltage Plot

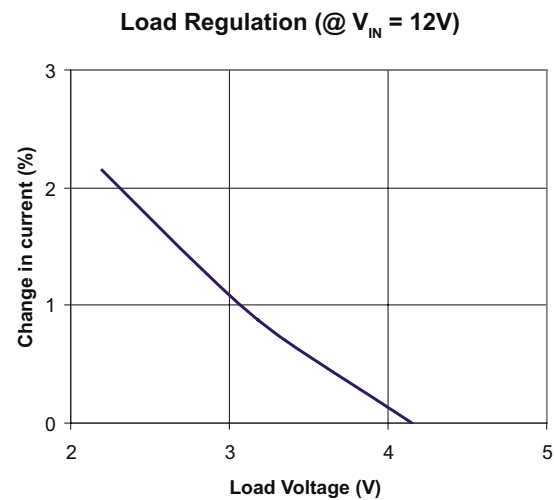

Fig. 4. Load Regulation of LED Current Plot

Constant Off-Time Mode:

The HV9910BDB3 is designed to be operated in the constant off-time mode when the load is two LEDs in series. In this mode, the line regulation of the LED current is less than 2% and the efficiency greater than 80%.

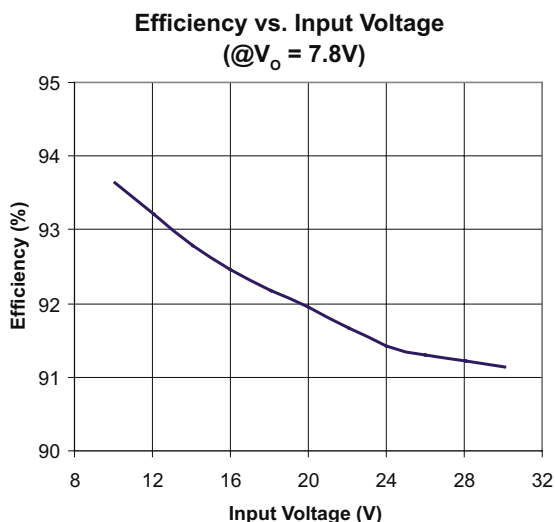

Fig. 5. Efficiency vs. Input Voltage Plot

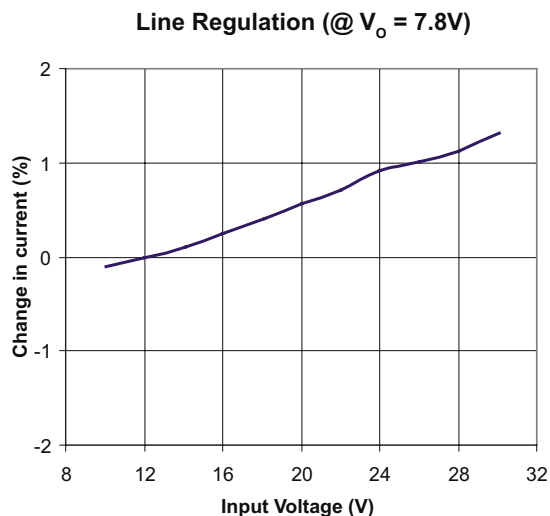

Fig. 6. Line Regulation of LED Current Plot

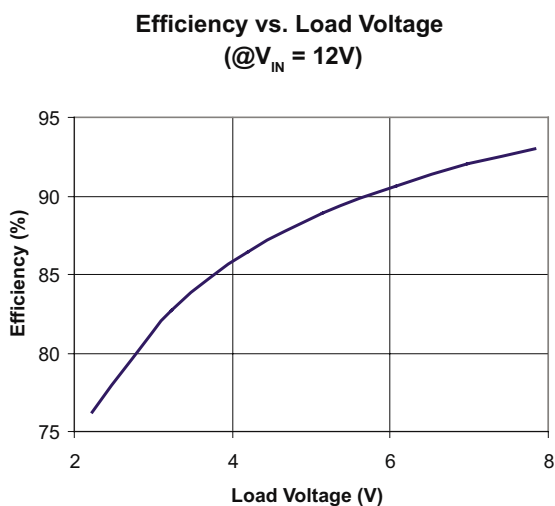

Fig. 7. Efficiency vs. Load Voltage Plot

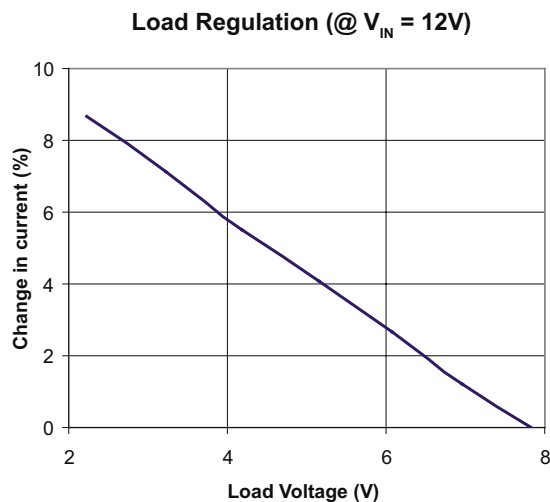

Fig. 8. Load Regulation of LED Current Plot

The variation in the switching frequency, when the HV9910BDB3 is operated in the constant off-time mode, is shown in Figs. 9 and 10.

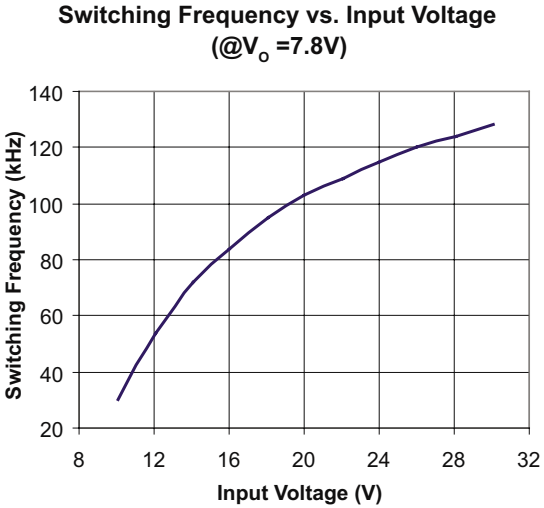

Fig. 9. Switching Frequency vs. Input Voltage Plot

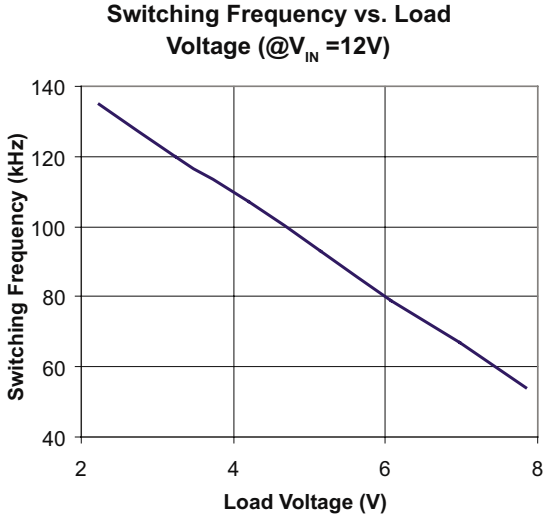
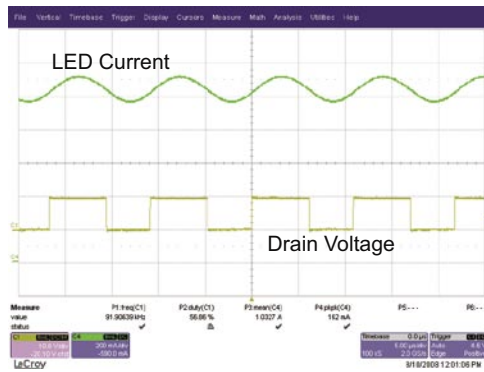

Fig. 10. Switching Frequency vs. Load Voltage Plot

Waveforms

Constant Frequency mode (LED Voltage = 3.3V):



(a) 10V input

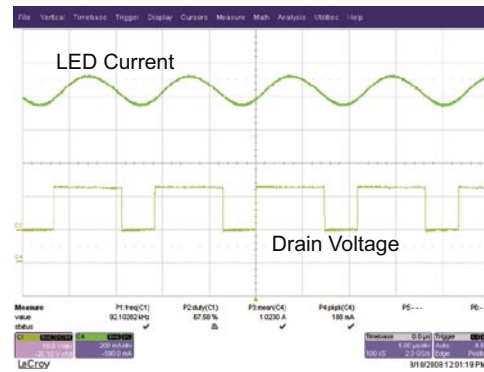

(b) 12V input

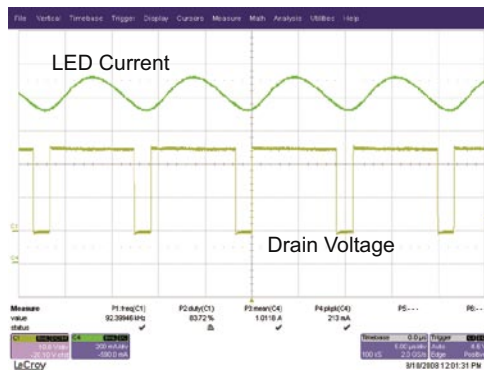

(c) 24V input

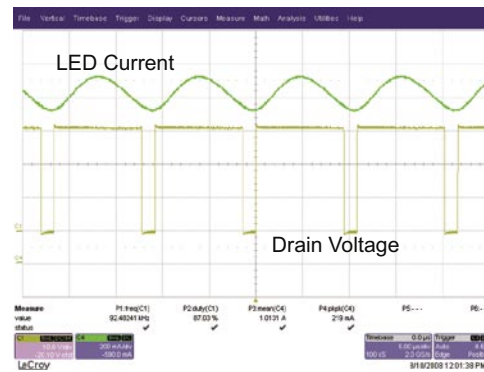

(d) 30V input

Fig.11. Steady State Waveforms in Constant Frequency Mode

C1 (Yellow) : Drain Voltage (10V/div)
 C4 (Green) : LED Current (200mA/div)
 Time Base : 5 μ s/div

Waveforms (cont.)

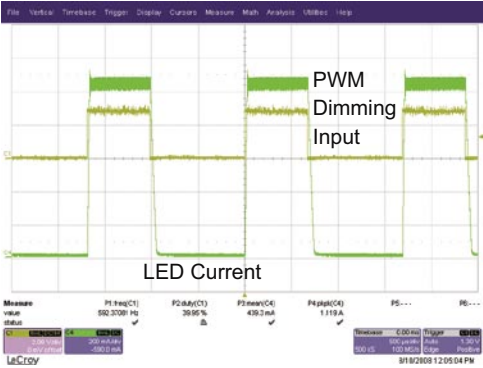

(a) PWM Dimming Performance

Time Scale : 500µs/div



(a) PWM Dimming Rise Time

Time Scale : 10µs/div



(b) PWM Dimming Fall Time

Time Scale : 10µs/div

Fig.12. PWM Dimming Performance in Constant Frequency Mode

C1 (Yellow) : PWMD Input Voltage (2V/div)
 C4 (Green) : LED Current (200mA/div)

Waveforms (cont.)

Constant Off-time mode (LED Voltage = 6.4V):

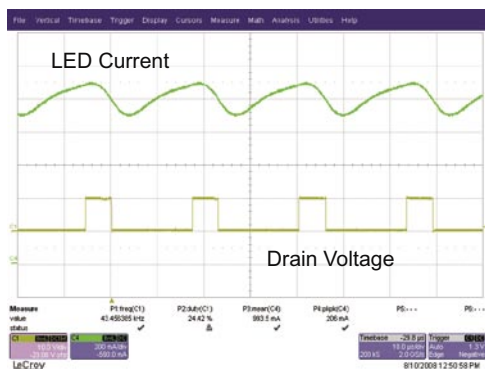

(a) 10V input

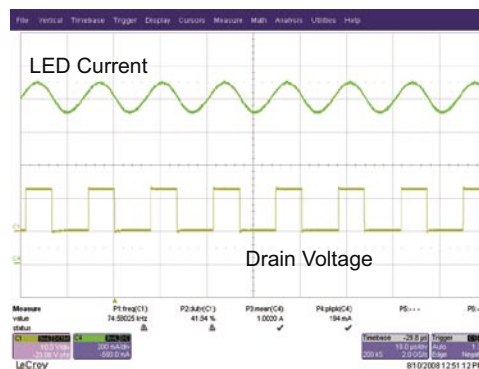

(b) 12V input

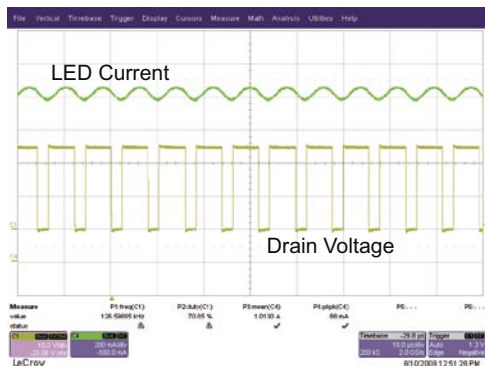

(c) 24V input

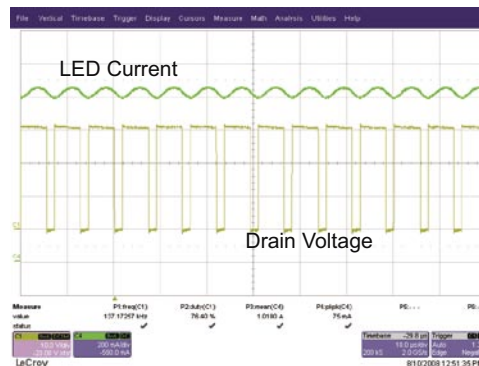

(d) 30V input

Fig.13. Steady State Waveforms in Constant Frequency Mode

C1 (Yellow)	:	Drain Voltage (10V/div)
C4 (Green)	:	LED Current (200mA/div)
Time Base	:	10µs/div

Waveforms (cont.)

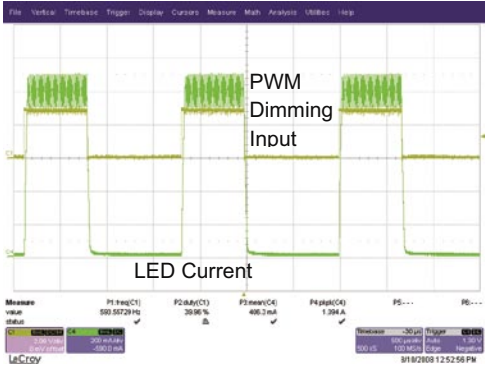

(a) PWM Dimming Performance

Time Scale : 500µs/div

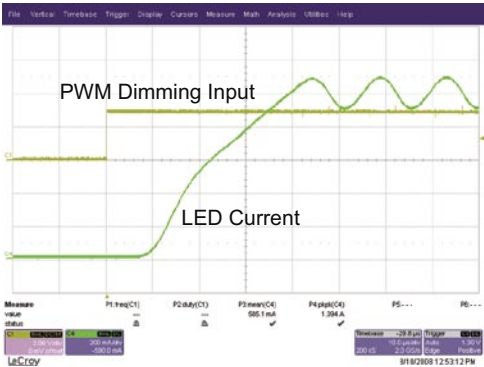

(b) PWM Dimming Rise Time

Time Scale : 10µs/div



(a) PWM Dimming Fall Time

Time Scale : 10µs/div

Fig.14. PWM Dimming Performance in Constant Frequency Mode

C1 (Yellow) : PWMD Input Voltage (2V/div)
 C4 (Green) : LED Current (200mA/div)

Schematic Diagram

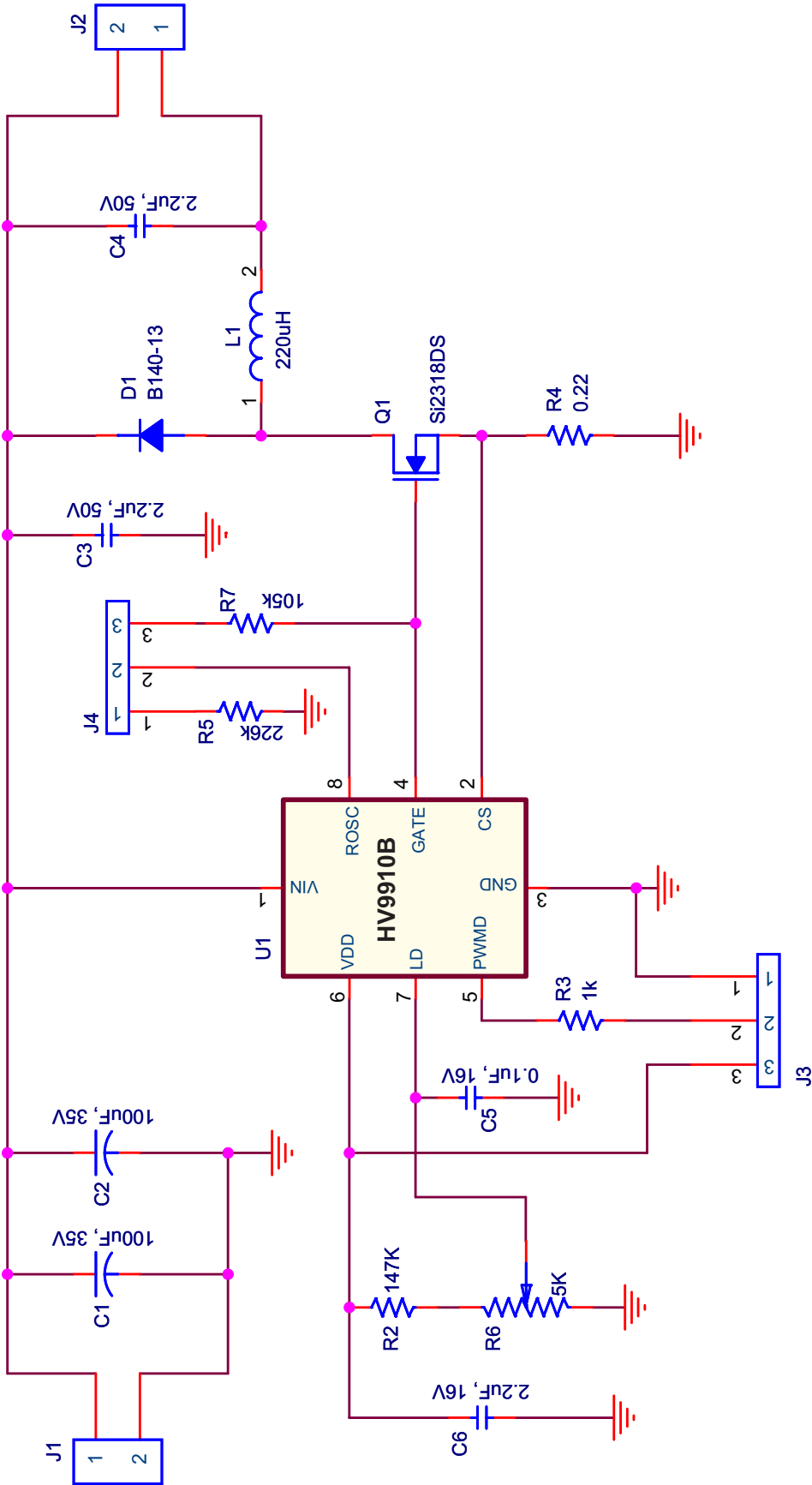

Bill of Materials

Item #	Quantity	Ref Des	Description	Package	Manufacturer	Manufacturer's Part Number
1	2	C1,C2	100 μ F, 35V, electrolytic capacitor	SMT	Panasonic	EEV-FK1V101P
2	2	C3,C4	2.2 μ F, 50V, X7R ceramic chip capacitor	SMD1206	Murata	GRM31CR71H225KA88L
3	1	C5	0.1 μ F, 16V X7R ceramic chip capacitor	SMD0805	Panasonic	ECJ-2VB1C104K
4	1	C6	2.2 μ F, 16V X7R ceramic chip capacitor	SMD0805	TDK Corp	C2012X7R1C225K
5	1	D1	40V, 1A schottky diode	SMA	Diodes Inc	B140-13
6	2	J1,J2	2 position, 5mm pitch, vertical header	Thru-Hole	On Shore Tech	EDSTL130/02
7	2	J3,J4	3 position, 0.100" pitch, vertical header	Thru-Hole	Molex	22-03-2031
8	1	L1	220uH, 1.3A rms, 2.4A sat inductor	SMT	Coiltronics	DR127-221-R
9	1	Q1	40V, 45m Ω , 10nC N-channel FET	SOT-23	Vishay	Si2318DS
10	1	R2	147K Ω , 1/8W, 1% chip resistor	SMD0805	-	-
11	1	R3	1k Ω , 1/8W, 1% chip resistor	SMD0805	-	-
12	1	R4	0.22 Ω , 1/4W, 1% chip resistor	SMD1206	-	-
13	1	R5	226k Ω , 1/8W, 1% chip resistor	SMD0805	-	-
14	1	R6	5K Ω top adjust trimpot	SMT	Bourns Inc	3361P-1-502G
15	1	R7	105k Ω , 1/8W, 1% chip resistor	SMD0805	-	-
16	1	U1	Universal LED Driver	SO-8	Supertex	HV9910BLG-G

Supertex inc. does not recommend the use of its products in life support applications, and will not knowingly sell them for use in such applications unless it receives an adequate "product liability indemnification insurance agreement." **Supertex inc.** does not assume responsibility for use of devices described, and limits its liability to the replacement of the devices determined defective due to workmanship. No responsibility is assumed for possible omissions and inaccuracies. Circuitry and specifications are subject to change without notice. For the latest product specifications refer to the **Supertex inc.** website: <http://www.supertex.com>.