

FEATURES

- Standard MityDSP-Pro SO-DIMM-200 Interface
- RS-232 Serial Interface
- USB Interface
 - 1.2/2.0 Compatible
 - 6 MBit Link Speed
 - Windows Drivers Available
- Two 10/100 MBit Ethernet Interfaces
 - One FPGA core based
 - One DSP EMAC based
- 5 High Speed LVDS Pairs
 - Supports Quarter VGA Interface
- Camera Link Interface
 - 16/20-bit per pixel support
- 8 On-Board Digital to Analog Converters
 - 12 Bit resolution
 - 1 μ s settling time

- 8 On-Board Analog to Digital Converters
 - 12 Bit resolution
 - 200 Ksps sample rate
- On-board Real Time Clock
- Four MDK-4 Daughter Card Expansion Slots
- Four MDK-8 Daughter Card Expansion Slots

APPLICATIONS

- MityDSP-Pro Evaluation
- Embedded Instrumentation
- Rapid Prototyping
- Control Processing
- Remote Sensing
- Embedded Signal Processing

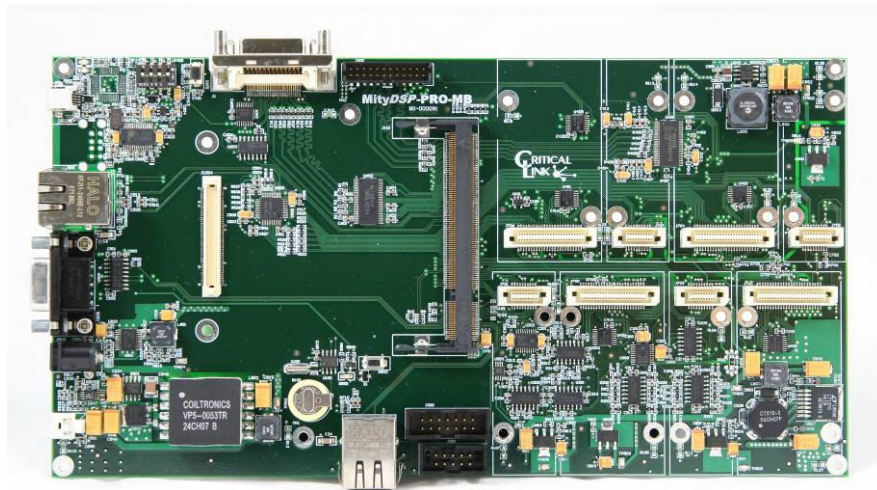

DESCRIPTION

The MityDSP-Pro Development Kit Motherboard (MDK-Pro-MB) provides a low-cost target platform for integration and development using the MityDSP-Pro based family of Processor Cards. The MDK-Pro-MB includes on board RS-232, 10/100 MBit Ethernet and Universal Serial Bus (USB) communications interfaces. For basic data acquisition and control, an 8 channel 12-bit DAC and an 8 channel 12-bit ADC is included. For display, an LVDS link connection to an off-board quarter VGA (QGVA) display controller with backlight driver is provided. A Camera Link interface is also provided.

In addition to the on-board I/O interfaces, the MDK-Pro-MB provides interfaces for four MDK-8 and four MDK-4 form factor daughter card sites for system expansion. The daughter card sites are laid out to also allow the use of MDK-12, MDK-16, and MDK-24 size daughter cards by combining card slots as described in the Daughter Card Configuration section, below. The MDK daughter cards allow customization of the system card based on the application. Users may select from several off-the-shelf cards available from Critical Link or design their own based on their specific requirements.

The MDK-Pro-MB includes on board voltage regulation for providing power digital and analog circuits. The card requires a power supply capable of providing a nominal +9 to +18 Volts DC. Input power can be supplied via the 2-pin 0.156" Molex header, or a standard barrel-style power jack.

A block diagram of the MDK-Pro-MB is illustrated in Figure 1. All available FPGA I/O lines and the two C645x McBSP ports are either used directly by the MDK-Pro-MB or are routed to the MDK daughter card sites. Control of the on-board interface hardware and connected daughter cards require proper configuration of the MityDSP-Pro FPGA and DSP. While not required, it is strongly recommended that the MityDSP software and firmware development kit and supplied API be used to manage these interfaces.

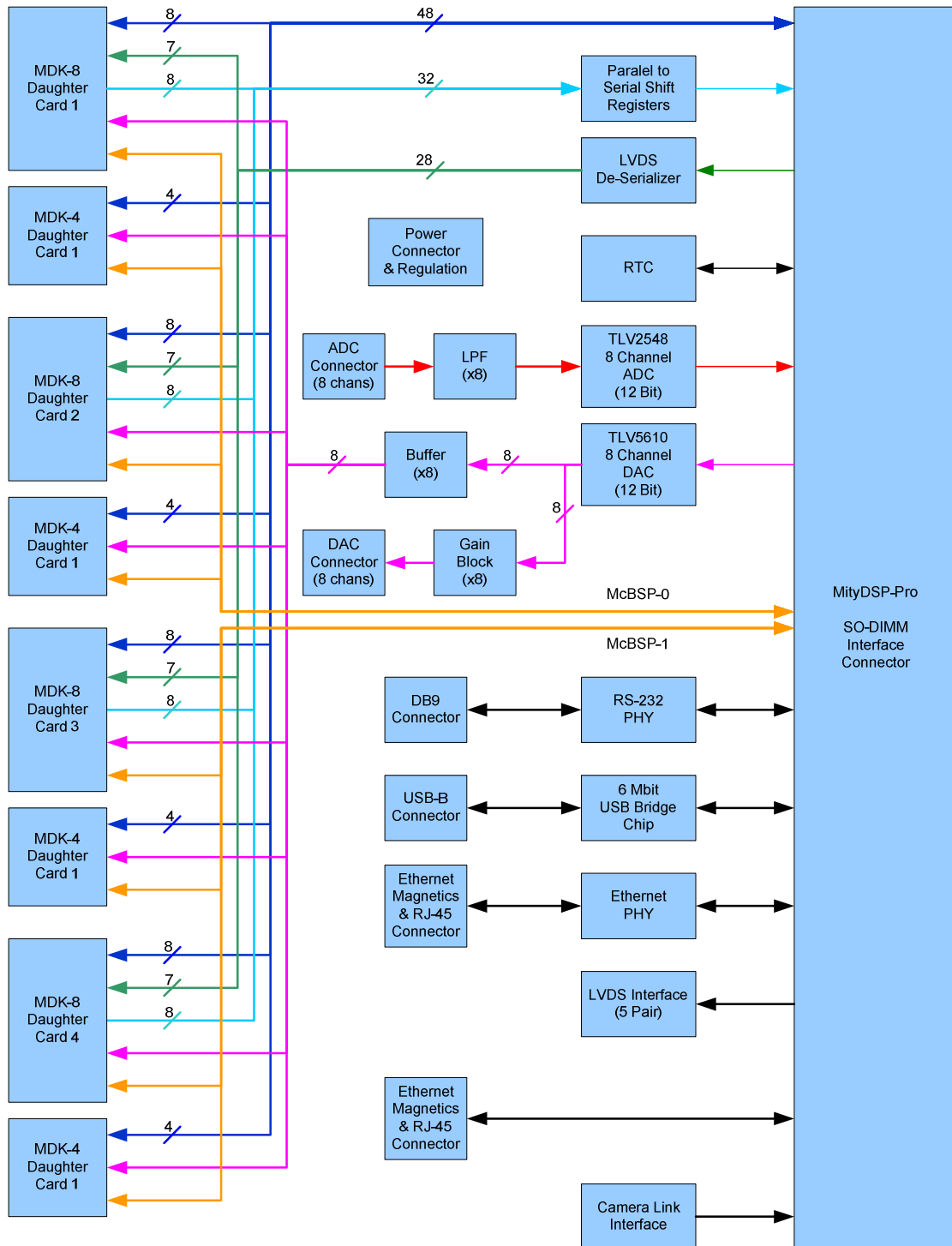

Figure 1: MityDSP-Pro Development Kit Block Diagram

RS-232 Interface Description

The on-board RS-232 level driver and DB-9 connector provides standard serial interface at data rates up to 115,200 baud. The serial interface is routed to the primary MityDSP-Pro serial bootloading port in order to allow remote code download and FLASH upgrades on an attached MityDSP-Pro from this connector.

USB Interface Description

The on-board USB interface leverages a serial UART to USB 2.0 compliant bridge chip that supports data rates up to 6 Mbits per second. Drivers for the USB interface are provided with the MityDSP software development kit and are compatible with Windows XP, 2000, and Vista. The USB serial interface is routed to the alternate MityDSP-Pro serial bootloading port in order to allow remote code download and FLASH upgrades on an attached MityDSP-Pro from this connector.

Ethernet Interfaces Description

The on-board Ethernet interface features a network PHY capable of running at 10/100 Mbit including link auto-negotiation and MII/MDIO capability. An industry standard RJ-45 connector is provided for an external connection. Use of the Ethernet interface requires an Ethernet Media Access Controller (MAC) implementation in the MityDSP-Pro FPGA. The MityDSP hardware and software development kit includes a fully tested Ethernet MAC as well as an implementation of the LwIP TCP/IP stack, providing a full Ethernet capable platform ready for integration. This Ethernet interface may be used to perform remote code download and FLASH upgrades on an attached MityDSP-Pro.

Also included on-board is a second Ethernet interface connector that is wired directly to the MityDSP-Pro's Ethernet PHY device. This PHY device is connected to the DSP's on-chip Ethernet MAC, and is capable of 10/100 Mbit operation. Support for this interface is included starting with MDK 2.7.0. Remote code download via this interface is supported by the bootloader, though it is only activated if an Ethernet MAC core is not found in the bootloader FPGA.

The DSP's on-chip MAC is actually capable of Gigabit operation, but this functionality requires a PHY device external to the MityDSP-Pro module (connectivity provided by its auxiliary interface connector), nor is such a PHY device included on the MityDSP-Pro motherboard.

LVDS Interface Description

The MDK-Pro-MB provides a flat-ribbon cable low profile interface for five Low Voltage Differential Signaling (LVDS) pairs. The interface design is intended to support high speed off board interconnects. In addition to custom user interfacing, the pairs may be used to interface to a Quarter VGA LCD screen using the MityDSP hardware and software development kit LCD interface libraries and an appropriate daughterboard interface. Off-the-shelf display solutions for QVGA interfaces are provided by Critical Link.

Camera Link Interface Description

The MDK-Pro-MB provides an interface port for connection to industry standard Camera Link compatible video sources. This feature enables the MDK-Pro-MB system to implement a Camera Link compatible frame grabber, and video processing engine. The interface carries 3-bits of sync signals plus 16-bits per pixel in any color mode, or black & white. The interface also supports Camera Link's bi-directional asynchronous serial control channel, and 4-bit uni-directional Camera Control lines.

DAC Description

The MDK-Pro-MB provides an on-board 8-channel 12-bit digital to analog converter to the MityDSP-Pro's TI C645x DSP via McBSP port-1. The DAC component is the TLV5610 from Texas Instruments® / Burr Brown® and is capable of output settling times of 1 μ s.

The eight channels are routed to the external DAC connector J200, a standard dual-row, 14-pin, 0.1" pitch shrouded header. All channels provide a voltage output range of 0 to 10 Volts with respect to AGND, and are buffered to provide an output impedance of less than 300 ohms.

The eight channels are also independently buffered and routed (1 each) to the four MDK-8 and the four MDK-4 daughter card slots, and provide an output range of 0 to 4.096 Volts. Note: Use of a daughter card that requires the use an associated DAC line implies that the corresponding pin on the external DAC connector should not be used. Please refer to the data sheet for a specific daughter card in order to determine if the DAC channel is required.

For details regarding the signal interface to the MityDSP-Pro McBSP port, please refer to the MDK-Pro-MB reference schematic. The MityDSP software development kit includes an API for interfacing to the TLV5610.

ADC Description

The MDK-Pro-MB provides an on-board 8-channel 12-bit analog to digital converter to the MityDSP-Pro's TI C645x DSP via McBSP port-0. The ADC component is the TLV2548 from Texas Instruments® / Burr Brown® and is capable of sampling at rates up to 200 Ksps, aggregate.

The eight input channels enter the board via a standard dual-row, 10-pin, 0.1" pitch shrouded header, J301. All input channels have an input range of 0 to 10 Volts with respect to AGND, and have an input impedance of 10k ohms. The signals are unity-gain buffered, and then low-pass filtered using a simple R/C network having a -3dB corner frequency of 48 kHz.

For details regarding the signal interface to the MityDSP-Pro McBSP port, please refer to the MDK-Pro-MB reference schematic. The MityDSP software development kit includes an API for interfacing to the TLV2548.

Real Time Clock Description

The MDK-Pro-MB provides a real-time clock using an I2C device with part number M41T81SM6F. Use of the RTC requires an implementation of an I2C driver interface within the FPGA of the MityDSP-Pro. The MityDSP software development kit includes an API for interfacing to the M41T81SM6F.

For details regarding the signal interface to the MityDSP-Pro I/O pins, please refer to the MDK-Pro-MB reference schematic.

ABSOLUTE MAXIMUM RATINGS

If Military/Aerospace specified cards are required, please contact the Critical Link Sales Office or unit Distributors for availability and specifications.

Maximum Supply Voltage	19 V
Storage Temperature Range	-65 to 80C
Shock, Z-Axis	±10 g
Shock, X/Y-Axis	±10 g

OPERATING CONDITIONS

Ambient Temperature Range	0 to 55C
Humidity	0 to 95% Non-condensing
Vibration, Z-Axis	TBS
Vibration, X/Y-Axis	TBS

ELECTRICAL CHARACTERISTICS

Symbol	Parameter	Conditions	Typical	Limit	Units (Limits)
Power Dissipation					
V _s	Supply Voltage.		12	9 / 18	Volts (Min/Max)
I _s	Supply Current.		0.33 ¹	1.0	Amps (Max)
On-Board Analog To Digital Converter					
BW _{ADC}	3 DB Bandwidth Analog to Digital Converter	R/C filtering	48	-	KHz
V _{Min,ADC}	Minimum Analog Input Voltage		0	TBD	Volts
V _{Max,ADC}	Maximum Analog Input Voltage		10	TBD	Volts
FS _{ADC}	Maximum Sample Rate, ADC			TBD	KHz
R _{IN, ADC-Ex†}	Input Impedance		10	8	KOhms (Min)
On-Board Digital To Analog Converter					
V _{Min,DAC-Ext}	Minimum Analog Input Voltage, External DAC connection.		0	-0.2	Volts
V _{Max,DAC-Ext}	Maximum Analog Input voltage External DAC connection.		10	10.2	Volts
V _{Min,DAC-DBC}	Minimum Analog Input Voltage, MDK-4/8 Daughter Board DAC Interface.		0	-0.2	Volts
V _{Max,DAC-DBC}	Maximum Analog Input Voltage, MDK-4/8 Daughter Board DAC Interface.		4.096	4.3	Volts
FS _{DAC}	Maximum Output Sample Rate, DAC		2	200	KHz
R _{out DAC-Ext}	Output Impedance		200	300	Ohms (Max)
MDK-8 Digital I/O					
F _{clk,din}	Clock Frequency, Digital Inputs		25	25	MHz
T _{update,din}	Update Period, Digital Inputs		1680	1680	ns
F _{clk,dout}	Clock Frequency, Digital Output LVDS clk entering deserializer		50	20 / 68	MHz (Min/Max)
T _{update,dout}	Update Period, Digital Outputs		20	14.7 / 50	ns (Min/Max)
Notes:					
1. Power Supply load is dependent on Daughter Card configuration and utilization.					

DAUGHTER CARD CONFIGURATION

The MDK-Pro-MB and daughter card system provides a high level of flexibility in configuration in order to maximize the use of the available MityDSP-Pro expansion pins. The daughter cards used in the MDK system are sized according to their complexity and number of required I/O pins to the MityDSP-Pro. There are several possible form factors: MDK-4, MDK-8, MDK-12, MDK-16, MDK-24, and MDK-48. The primary form factors, however, are the MDK-4 and MDK-8 configurations. All of the other factors listed are simply a combination of these card sizes.

Figure 2 provides a top view of the MDK-Pro-MB circuit card and its corresponding interface connectors. In the figure, the daughter card sites are located on the right hand side of the board. The basic MDK-4 and MDK-8 card connectors are divided evenly into the top half of the card and the bottom half of the card. While this section illustrates configurations for the bottom half of the card, please note that the top half provides similar connectivity.

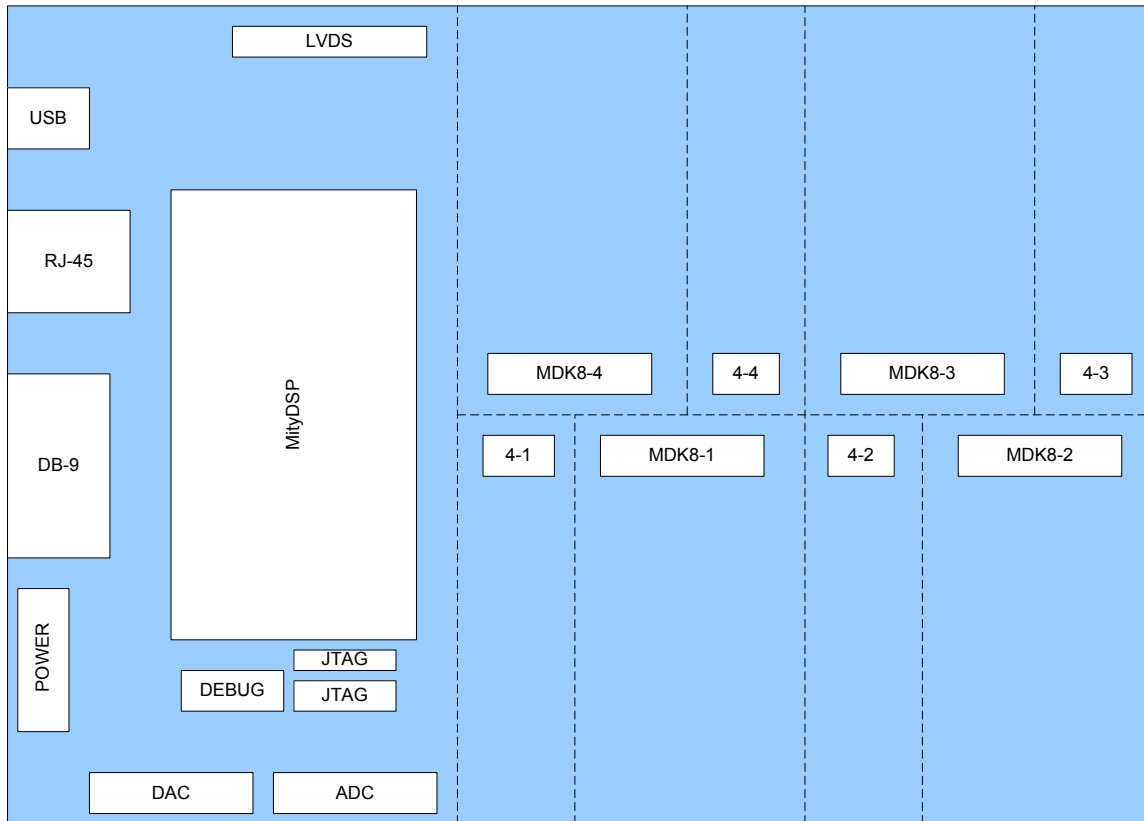

Figure 2: MDK-Pro-MB Connector Locations, Top View

Figure 3 illustrates the bottom half of the MDK-Pro-MB daughter card expansion area using two each of the MDK-4 and MDK-8 form factor daughter cards. In this configuration, the cards are simply plugged into their corresponding connectors on the board.

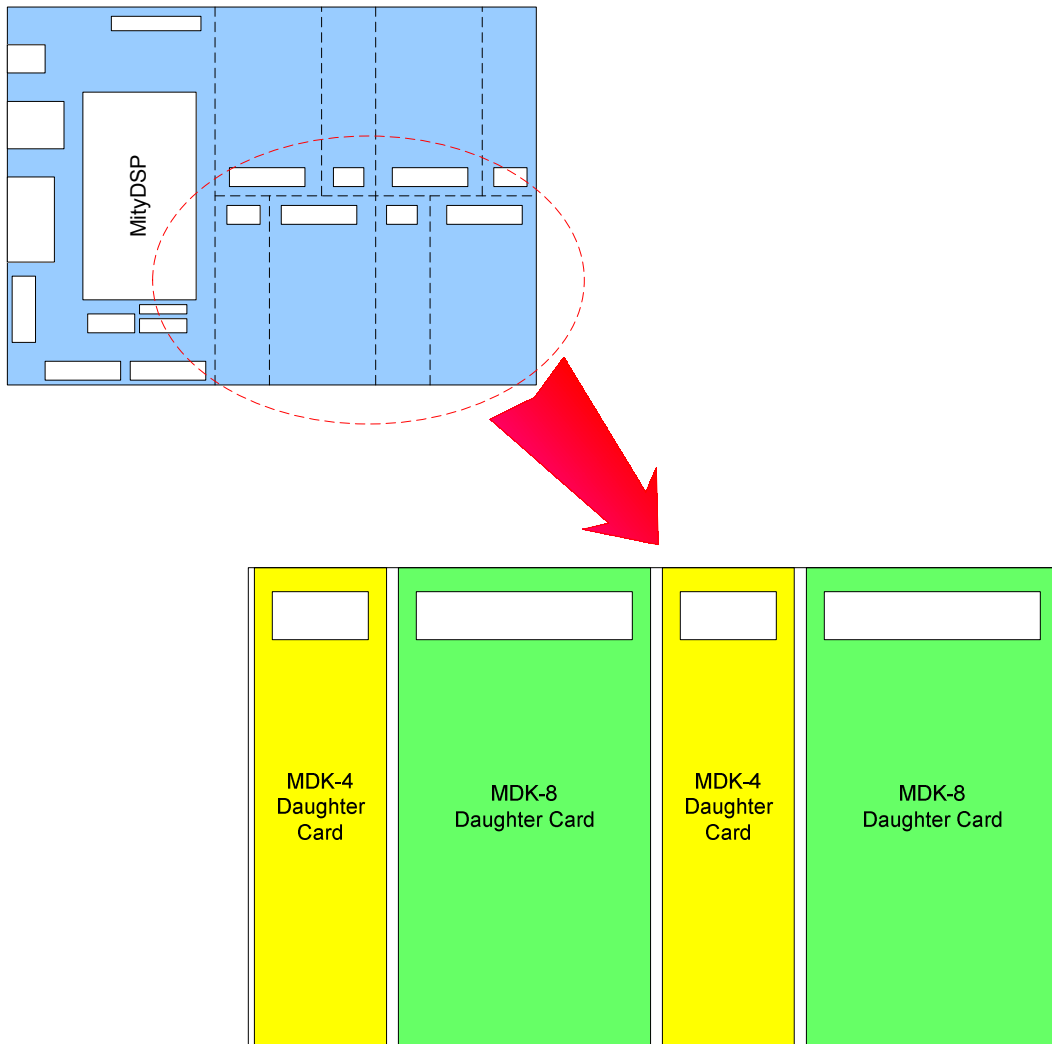

Figure 3: Daughter Card Configuration, 2 MDK-4 and 2 MDK-8 Cards (Top View)

Figure 4 illustrates the use of MDK-12 form factor daughter cards, which occupy one each of the MDK-4 and MDK-8 slot connectors. As is shown in Figure 5, the MDK-12 cards may be mixed and matched with MDK-4 or MDK-8 cards in an MDK-Pro-MB configuration. Card slots may be left empty.

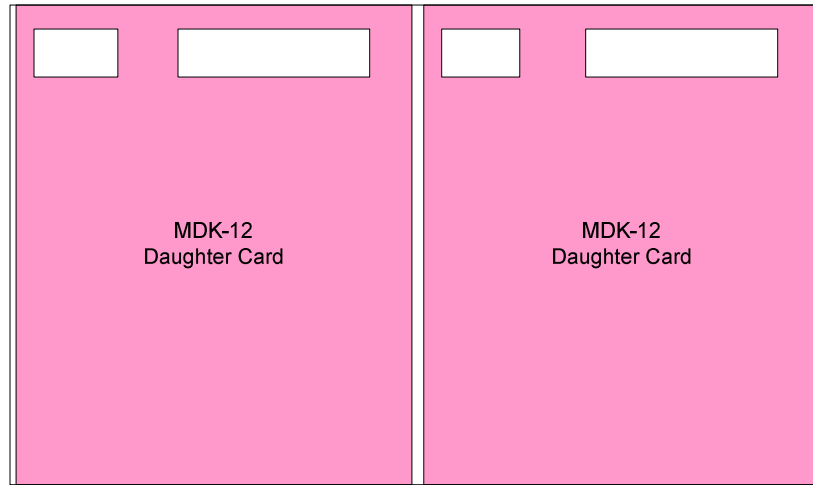

Figure 4: Daughter Card Configuration, 2 MDK-12 Cards (Top View)

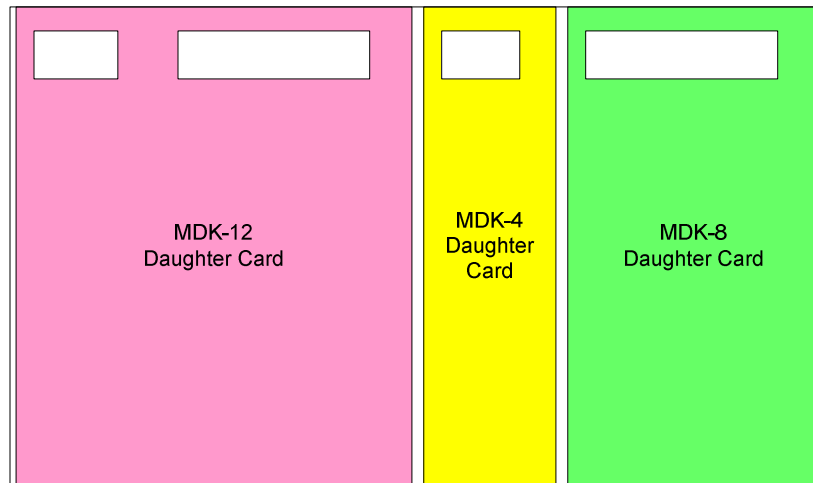

Figure 5: Daughter Card Configuration, 1 each MDK-12, MDK-4, and MDK-8 (Top View)

Use of an MDK-16 Daughter Card requires two MDK-4 slots and an MDK-8 slot as shown in Figure 6.

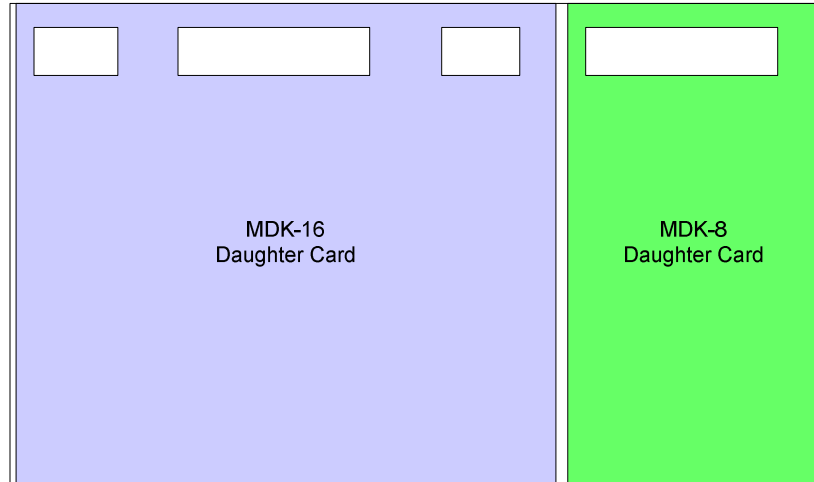

Figure 6: Daughter Card Configuration, MDK-16 and MDK-8 (Top View)

The MD-24 uses two each of the MDK-4 and MDK-8 slots as shown in Figure 7. Similarly (and not shown), an MDK-48 card would use all available slots on the MDK-Pro-MB. MDK-48 cards are typically full custom designs.

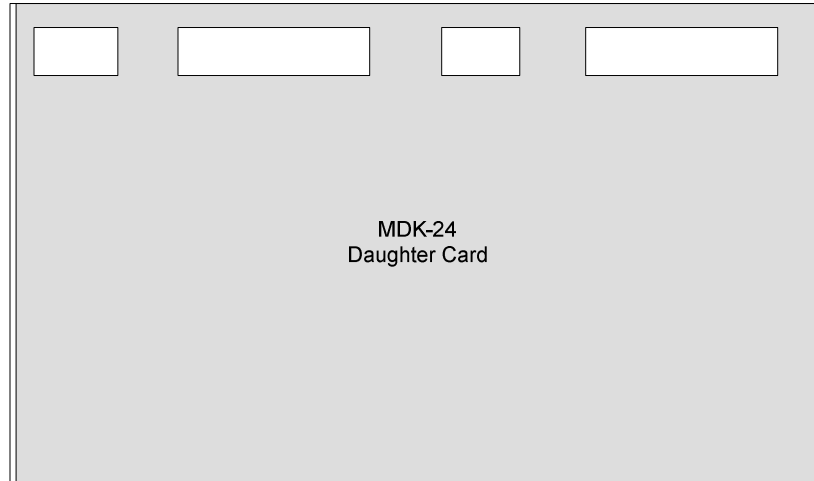

Figure 7: Daughter Card Configuration MDK-24 (Top View)

ELECTRICAL INTERFACE DESCRIPTION

MityDSP-Pro JTAG Interface

The DSP/FPGA JTAG connection is made directly on the MityDSP-Pro module. See the MityDSP-Pro datasheet for details.

Input Power

The MDK-Pro-MB power interface, J800 or J801, requires a single +9 to +18 Volt power supply. J800 is a 2.1mm-ID, 5.5mm-OD barrel-style power jack, center-positive. J801 is a standard 2-pin, 0.156" pitch Molex locking header. The Pin-out for the power interfaces is included in Table 1.

Table 1: Input Power Interface Pin Description

Signal	J800 Position	J801 Position
+9 to +18 Volts	Center-pin	1
GND	Outer-ring	2

Analog I/O Connectors

The MDK-Pro-MB provides two double-row shrouded connectors for the on-board DAC circuit outputs and the on board ADC connectors. Table 2 defines the DAC external interface connectors. A cable using AMP[®] connector 1658621-2 (or equivalent) should be used. All channels provide a voltage output range of 0 to 10 Volts with respect to AGND, and are buffered to provide an output impedance of less than 300 ohms. Note that all DAC outputs are also shared with the MDK daughter card slots. MDK cards that require use of the DACs preclude the use of the external interface DAC channel.

Table 2: J200 On-Board DAC External Interface Connector

Pin	Signal	Shared Slot
1	AGND	N/A
2	AGND	N/A
3	AGND	N/A
4	DAC_1	MDK8-1
5	DAC_2	MDK8-2
6	DAC_3	MDK8-3
7	DAC_4	MDK8-4
8	DAC_5	MDK4-1
9	DAC_6	MDK4-2
10	DAC_7	MDK4-3
11	DAC_8	MDK4-4
12	AGND	N/A
13	AGND	N/A
14	AGND	N/A

Table 3 defines the ADC external interface connectors. A cable using AMP[®] connector 1658621-1 (or equivalent) should be used. All input channels have an input range of 0 to 10 Volts with respect to AGND, and have an input impedance of 10k ohms.

Table 3: J301 On-Board ADC External Interface Connector

Pin	Signal
1	AGND
2	ADC_1
3	ADC_2
4	ADC_3
5	ADC_4
6	ADC_5
7	ADC_6
8	ADC_7
9	ADC_8
10	AGND

LVDS Interface

The LVDS interface connector provides up to 5 pairs of LVDS signals connected to the Spartan 3 device on a connected MityDSP-Pro. The interface uses a standard 2 mm 24 position male header.

Table 4 defines the LVDS connector pinout. A cable using Molex® 87568-2493 connector (or equivalent) should be used. Use of the LVDS pairs as outputs will require addition of termination resistors (100 Ohm) on externally designed circuit assemblies. Use of the LVDS pairs as inputs will require population of 0603 sized termination resistors on the MDK-Pro-MB on the provided solder pads. Refer to the detailed schematic and assembly drawing for further information.

Table 4: J600 LVDS Interface Pin Description

Pin	Signal	Type	Standard	Notes
1	+5 V	-	-	500 mA Max.
2	+5 V	-	-	500 mA Max.
3	GND	-	-	
4	GND	-	-	
5	DISP_A0_P	I/O	LVDS	Display/LVDS Data channel 0
6	DISP_A0_N	I/O	LVDS	Display/LVDS Data channel 0
7	DISP_A1_P	I/O	LVDS	Display/LVDS Data channel 1
8	DISP_A1_N	I/O	LVDS	Display/LVDS Data channel 1
9	DISP_A2_P	I/O	LVDS	Display/LVDS Data channel 2
10	DISP_A2_N	I/O	LVDS	Display/LVDS Data channel 2
11	DISP_A3_P	I/O	LVDS	Display/LVDS Data channel 3
12	DISP_A3_N	I/O	LVDS	Display/LVDS Data channel 3
13	GND	-	-	
14	GND	-	-	
15	DISP_CLKIN_P	I/O	LVDS	Display/LVDS Clock (or Data)
16	DISP_CLKIN_N	I/O	LVDS	Display/LVDS Clock (or Data)
17	GND	-	-	
18	P_SW	I/O/PU	CMOS	Display Aux. I/O (push-button switch)
19	DISP_I2	I	CMOS	Display Touch-screen Input 2
20	DISP_I1	I	CMOS	Display Touch-screen Input 1
21	DISP_I0	I	CMOS	Display Touch-screen Input 0
22	DISP_O2	O	CMOS	Display Touch-screen Output 2
23	DISP_O1	O	CMOS	Display Touch-screen Output 1
24	DISP_O0	O	CMOS	Display Touch-screen Output 0

Camera Link Interface

The Camera Link interface connector provides connection to industry standard Camera Link compatible cameras or other video sources. The Camera Link standard defines this connector to be an MDR-26 connector from 3M[®]. As specified in the standard, Table 5 defines the pinout of this connector. The high speed LVDS lines are connected to a National Semiconductor[®] Channel Link[®] SERDES receiver chip, which translates the high speed interface to a more manageable speed, though wider, LVCMOS bus connected to the MityDSP-Pro interface pins. For more information on Camera Link, please refer to the Camera Link Standard specification. For more information on Channel Link, please refer to National Semiconductor's website.

Table 5: J1 Camera Link Interface connector (MDR-26)

Pin	Signal	Type	Standard	Notes
1	Inner shield	-	-	Tied to Digital GND
14	Inner shield	-	-	Tied to Digital GND
2	CC4-	O	LVDS	Camera Control channel 4
15	CC4+	O	LVDS	Camera Control channel 4
3	CC3+	O	LVDS	Camera Control channel 3
16	CC3-	O	LVDS	Camera Control channel 3
4	CC2-	O	LVDS	Camera Control channel 2
17	CC2+	O	LVDS	Camera Control channel 2
5	CC1+	O	LVDS	Camera Control channel 1
18	CC1-	O	LVDS	Camera Control channel 1
6	SerTFG+	I	LVDS	Serial to Frame Grabber
19	SerTFG-	I	LVDS	Serial to Frame Grabber
7	SerTC-	O	LVDS	Serial to Camera
20	SerTC+	O	LVDS	Serial to Camera
8	X3+	I	LVDS	Video SERDES Link channel 3
21	X3-	I	LVDS	Video SERDES Link channel 3
9	Xclk+	I	LVDS	Video SERDES Link clock
22	Xclk-	I	LVDS	Video SERDES Link clock
10	X2+	I	LVDS	Video SERDES Link channel 2
23	X2-	I	LVDS	Video SERDES Link channel 2
11	X1+	I	LVDS	Video SERDES Link channel 1
24	X1-	I	LVDS	Video SERDES Link channel 1
12	X0+	I	LVDS	Video SERDES Link channel 0
25	X0-	I	LVDS	Video SERDES Link channel 0
13	Inner shield	-	-	Tied to Digital GND
26	Inner shield	-	-	Tied to Digital GND

MDK-8 Daughter Card Interface

The MDK-Pro-MB provides four MDK-8 Daughter Card interface positions. Each position includes one 50 position dual row socket. Mating connectors for these sockets are the Hirose FX6-50P-0.8SV plugs. Table 6 defines the signals on each pin for the cards. Table 8 provides the electrical standards for the various nets.

Table 6: Daughter Card – MDK-8 Connector Pin Assignments

Pin	Signal	Pin	Signal
A1	IO_0	B1	+5 V
A2	IO_1	B2	+5 V
A3	IO_2	B3	+3.3 V
A4	IO_3	B4	+3.3 V
A5	IO_4	B5	+12 VA
A6	IO_5	B6	GND
A7	IO_6	B7	GND
A8	IO_7	B8	GND
A9	DO_0	B9	-12 VA
A10	DO_1	B10	+15 V
A11	DO_2	B11	+15 V
A12	DO_3	B12	-15 V
A13	DO_4	B13	-15 V
A14	DO_5	B14	AGND
A15	DO_6	B15	AGND
A16	DI_0	B16	DO_CLK
A17	DI_1	B17	RSV
A18	DI_2	B18	RSV
A19	DI_3	B19	RSV
A20	DI_4	B20	RSV
A21	DI_5	B21	RSV
A22	DI_6	B22	RSV
A23	DI_7	B23	RSV
A24	ADC	B24	RSV
A25	DAC	B25	RSV

MDK-4 Daughter Card Interface

The MDK-Pro-MB provides 4 MDK-4 Daughter Card interface positions. Each position includes one 20 position dual row socket. Mating connectors for these sockets are the Hirose FX6-20P-0.8SV plugs. Table 7 defines the signals on each pin for the cards. Table 8 provides the electrical standards for the various nets.

Table 7: Daughter Card MDK-4 Connector Assignments

Pin	Signal	Pin	Signal
A1	IO_0	B1	+5V
A2	IO_1	B2	+5V
A3	IO_2	B3	+3.3V
A4	IO_3	B4	+3.3V
A5	+15 V	B5	GND
A6	+15 V	B6	GND
A7	DAC	B7	RSV
A8	AGND	B8	RSV
A9	RSV	B9	RSV
A10	RSV	B10	RSV

Daughter Card Signal Description

Table 8: Daughter Card Signal Description

Signal	Type	Standard	Notes
IO_##	I/O	3.3V CMOS	Direct Interface to MityDSP-Pro Spartan3 FPGA.
DO_##	O	3.3V CMOS	Digital Output. Update Rate of 20 nsec. DO_CLK provides sampling clock – outputs should be sampled on rising edge.
DI_##	I	3.3V CMOS	Digital Input. Sampling interval < 2 μ s.
DAC_1 DAC_2 DAC_3 DAC_4	O	0-4.096 V	12 Bit.
ADC_1 ADC_2 ADC_3 ADC_4	I	0-2 V	12 Bit. 10 Khz R/C filtering.

MECHANICAL INTERFACE DESCRIPTION

Main Board Interface / Mounting

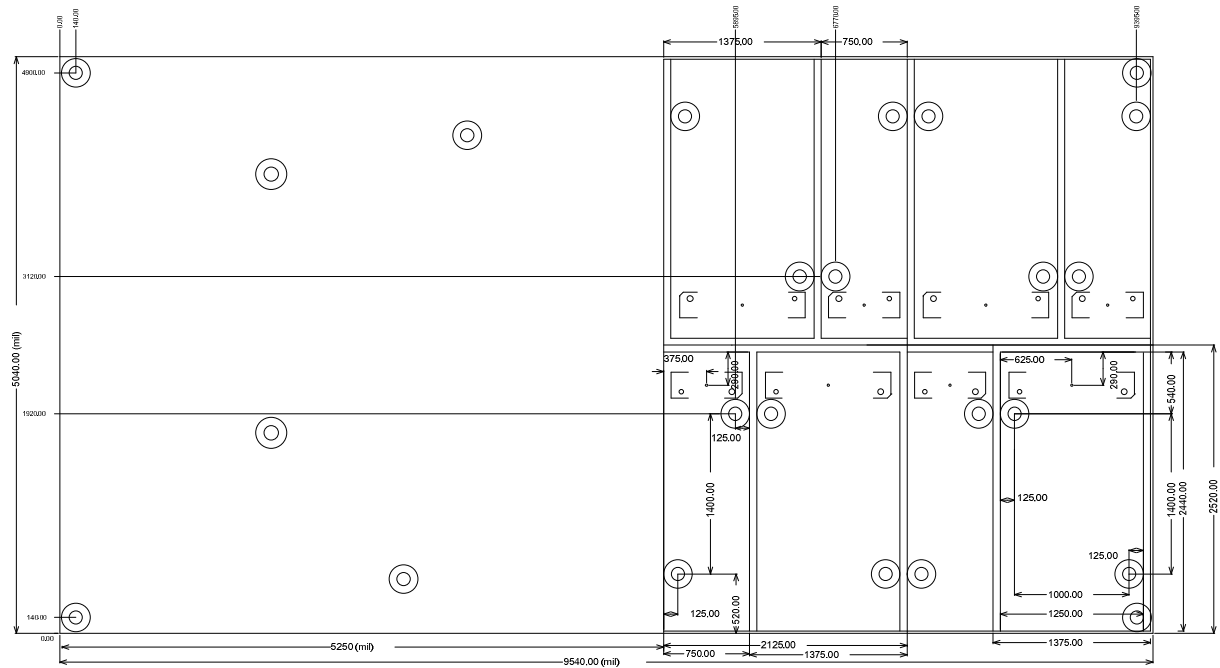

Figure 8: MDK-Pro-MB PCB Outline and Mounting Hole Locations (Top View, mils)

Daughter Card Interface / Mounting

Mechanical outlines for each of the MDK-4 and MDK-8 form factors are shown in Figure 9 and Figure 10, respectively. For larger MDK-12, MDK-16, and MDK-24 form factors, a 1/8th inch gap (125 mils) is required between each of the board outlines. Figure 12 illustrates and MDK-16 form factor board with the necessary spacing.

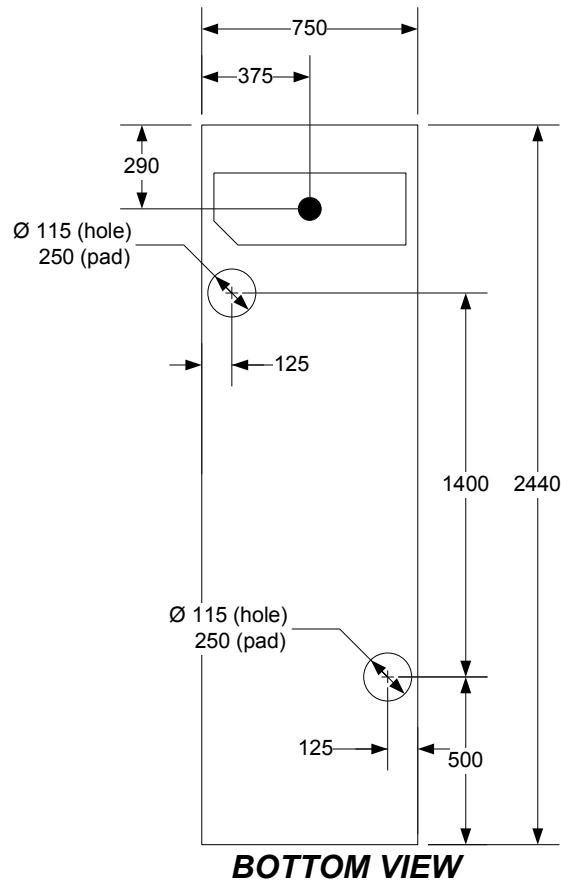

Figure 9: MDK-4 Mounting Hole, Size, and Hirose Connector location (units in mils)

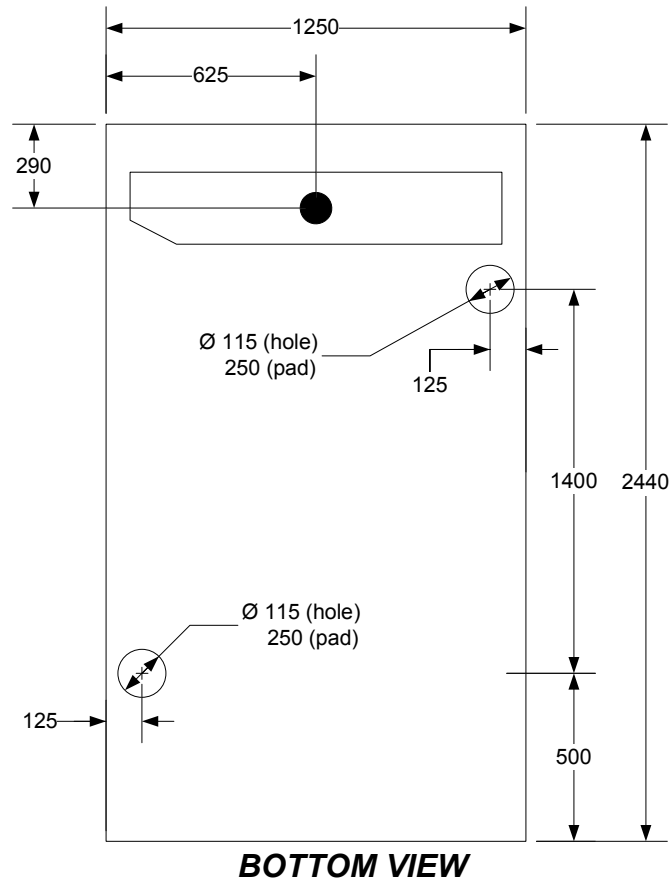
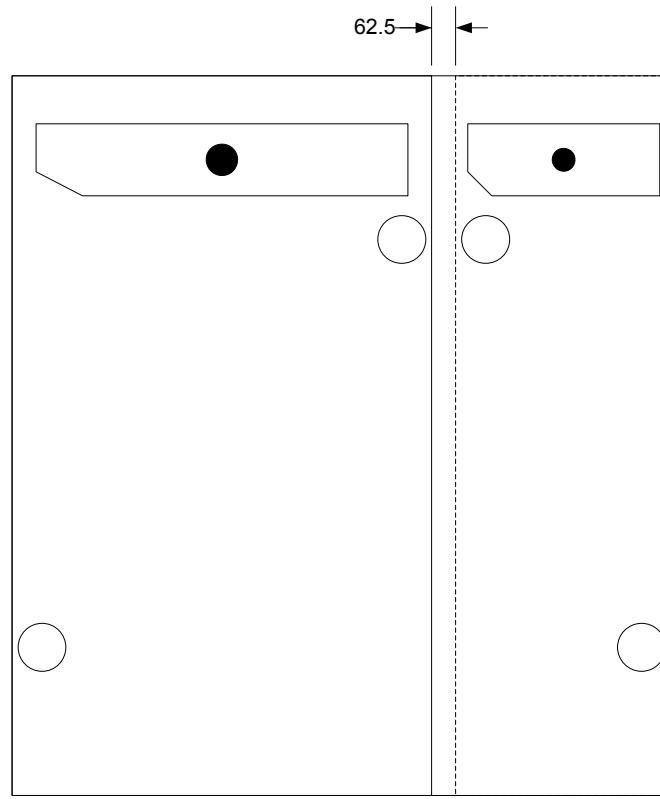
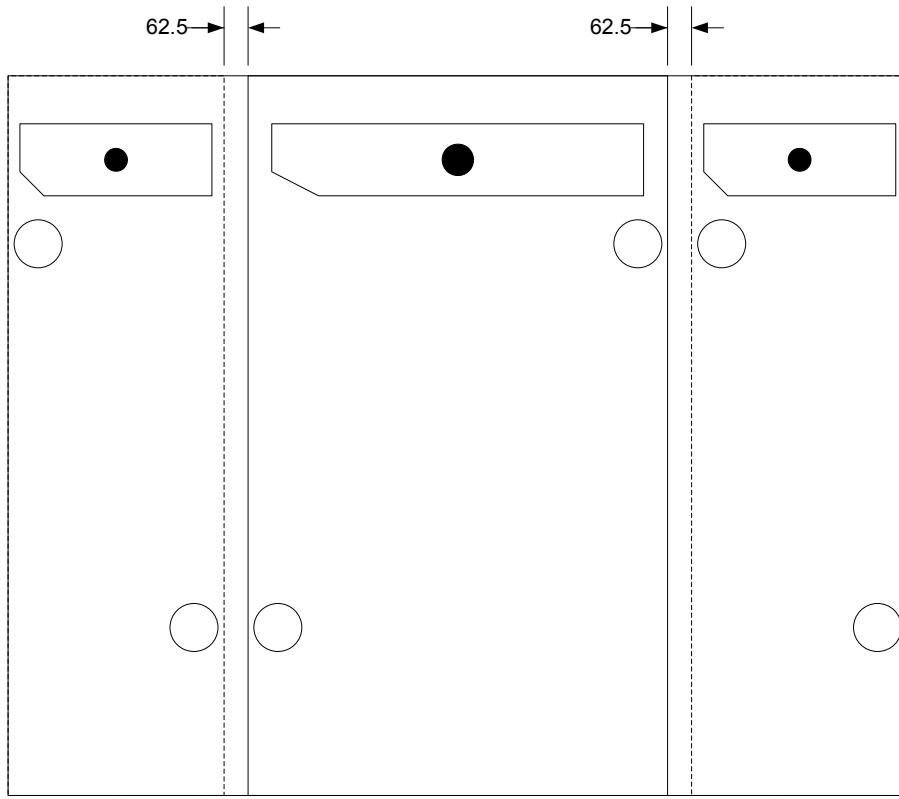

Figure 10: MDK-8 Mounting Hole, Size, and Hirose Connector location (units in mils)



BOTTOM VIEW

Figure 11: MDK-12 Alignment (MDK-4 and MDK-8 footprints separated by 62.5 mils)



BOTTOM VIEW

Figure 12: MDK-16 Alignment (MDK-4 and MDK-8 footprints separated by 62.5 mils)

In the vertical dimension, the base board to board spacing is 7 mm. The MDK-Pro-MB includes components underneath the area used by the MDK daughter boards. 4.5 mm has been reserved for use by these components. Therefore, MDK daughter boards must be designed requiring no more than 2.5 mm of clearance for bottom side mounted components. This is illustrated in Figure 13.

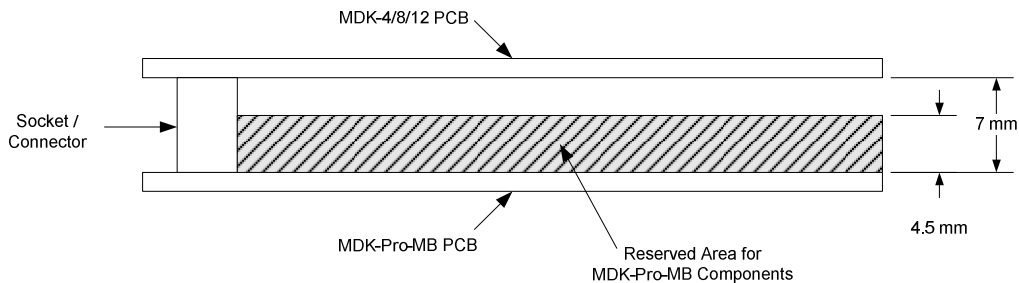

Figure 13: Required Bottom Clearance, MDK board designs

MityDSP-Pro Interface

Table 9: MityDSP-Pro/SO-DIMM Connector Assignments

Pin	I/O	Signal	Pin	I/O	Signal
1	-	3.3 V	2	-	3.3 V
3	-	3.3 V	4	-	3.3 V
5	-	3.3 V	6	-	3.3 V
7	-	GND	8	-	GND
9	-	GND	10	-	GND
11	I	MRESET#	12	I	BOOT_MODE
13	O	ETH_TD_P	14	O	RS232_TXD
15	O	ETH_TD_N	16	I	RS232_RXD
17	I	ETH_RD_P	18	O	RS232_RTS
19	I	ETH_RD_N	20	I	RS232_CTS
21	-	FPGA_RSV1	22	O	SCL
23	-	FPGA_RSV2	24	I/O	SDA
25	I/O	CLKR0	26	I/O	CLKR1
27	I/O	CLKX0	28	I/O	CLKX1
29	I	DR0	30	I	DR1
31	O	DX0	32	O	DX1
33	I/O	FSR0	34	I/O	FSR1
35	I/O	FSX0	36	I/O	FSX1
37	-	VCCO_2	38	-	VCCO_1
39	-	VCCO_0	40	-	VCCO_7
41	-	GND	42	-	GND
43	I/O	DC1_IO8	44	O	USB_TXD
45	I/O	DC1_IO9	46	I	USB_RXD
47	I/O	DC1_IO10	48	O	USB_RTS
49	I/O	DC1_IO11	50	I	USB_CTS
51	I/O	DC1_IO0	52	O	DI_CLK
53	I/O	DC1_IO1	54	O	DI_LOAD
55	I/O	DC1_IO2	56	O	ADC_CS
57	I/O	DC1_IO3	58	I	DI_DAT
59	I/O	DC1_IO4	60	O	RTC_SCL
61	I/O	DC1_IO5	62	I/O	RTC_SDA
63	-	GND	64	-	GND
65	I/O	DC1_IO6	66	I/O	ETH_MDIO
67	I/O	DC1_IO7	68	O	ETH_MDC
69	I/O	DC2_IO8	70	O	25MHZ_REF_CLK
71	I/O	DC2_IO9	72	O	ETH_RESET#
73	I/O	DC2_IO10	74	I	ETH_RX_CLK
75	I/O	DC2_IO11	76	I	ETH_RX_DV
77	I/O	DC2_IO2	78	I	ETH_CRS
79	I/O	DC2_IO1	80	I	ETH_RX_ER
81	I/O	DC2_IO3	82	I	ETH_COL
83	I/O	DC2_IO4	84	I	ETH_RXD0
85	-	GND	86	-	GND
87	I/O	DC2_IO5	88	I	ETH_RXD1
89	I/O	DC2_IO6	90	I	ETH_RXD2
91	I/O	DC2_IO7	92	I	ETH_RXD3
93	I/O	DC2_IO0	94	I	ETH_TX_CLK
95	I/O	DC4_IO0	96	O	ETH_TX_EN
97	I/O	DC4_IO1	98	O	ETH_TXD0

Pin	I/O	Signal	Pin	I/O	Signal
99	I/O	DC4_IO2	100	O	ETH_TXD1
101	I/O	DC4_IO3	102	O	ETH_TXD2
103	I/O	DC4_IO4	104	O	ETH_TXD3
105	I/O	DC4_IO5	106	O	SerTC
107	-	GND	108	-	GND
109	I/O	DC4_IO6	110	I	SerTFG
111	I/O	DC4_IO7	112	O	CC_ENABLE
113	I/O	DC4_IO8	114	I	X_0
115	I/O	DC4_IO9	116	I	X_CLK
117	I/O	DC4_IO10	118	I	X_1
119	I/O	DC4_IO11	120	I	X_2
121	I/O	DC3_IO0	122	I	X_3
123	I/O	DC3_IO1	124	I	X_4
125	I/O	DC3_IO2	126	I	X_5
127	I/O	DC3_IO3	128	I	X_6
129	-	GND	130	-	GND
131	I/O	DC3_IO4	132	I	X_7
133	I/O	DC3_IO5	134	I	X_8
135	I/O	DC3_IO6	136	I	X_9
137	I/O	DC3_IO7	138	I	X_10
139	I/O	DC3_IO8	140	I	X_11
141	I/O	DC3_IO9	142	I	X_12
143	I/O	DC3_IO10	144	I	X_13
145	I/O	DC3_IO11	146	I	X_14
147	O	CC1	148	I	X_27
149	O	CC2	150	I	X_26
151	-	GND	152	-	GND
153	O	CC3	154	I	X_25
155	O	CC4	156	I	X_24
157	-	Unused	158	I	X3_P
159	-	Unused	160	I	X3_N
161	-	Unused	162	I	XClk_P
163	-	Unused	164	I	XClk_N
165	-	Unused	166	I	X2_P
167	-	Unused	168	I	X2_N
169	I	X0_P	170	I	X1_P
171	I	X0_N	172	I	X1_N
173	-	GND	174	-	GND
175	O	DO_A3_P	176	O	DISP_A0_P
177	O	DO_A3_N	178	O	DISP_A0_N
179	O	DO_CLKIN_P	180	O	DISP_A1_P
181	O	DO_CLKIN_N	182	O	DISP_A1_N
183	O	DO_A2_P	184	O	DISP_A2_P
185	O	DO_A2_N	186	O	DISP_A2_N
187	O	DO_A1_P	188	O	DISP_A3_P
189	O	DO_A1_N	190	O	DISP_A3_N
191	O	DO_A0_P	192	O	DISP_CLKIN_P
193	O	DO_A0_N	194	O	DISP_CLKIN_N
195	-	GND	196	-	GND
197	-	3.3V	198	-	3.3V
199	-	3.3V	200	-	3.3V

MDK Interface Cards

Table 10: MDK Off-The-Shelf Interface Cards (see www.mitydsp.com for latest list)

Card Number	Description / Features	MDK-4	MDK-8	MDK-12	MDK-16	MDK-24	Other
MDK4-RS232	Single RS-232 Interface Card with hardware flow control lines (no modem control) OR Dual RS-232 Interface without flow control	X					
MDK4-RS485	RS-485 Interface Card supporting 2 output and 2 input signaling lines.	X					
MDK4-SD	SD-FLASH interface card controller, SPI mode.	X					
MDK4-TSA	Touch Screen Adaptor	X					
MDK8-ADS8239	1 Msps 16 bit Analog to Digital Converter utilizing ADS8239.		X				
MDK8-ADS8344	8 channel 16 bit 100 Msps Analog to Digital Converter utilizing ADS8344.		X				
MDK8-DIGIOISO	TTL Discrete Input/Output Interface Card, isolated inputs/outputs.		X				
MDK8-A3967	Independent dual axis stepper motor controller, micro-stepping down to 1/8 step size.		X				
MDK12-TTLIO	TTL Discrete Input/Output Interface Card			X			
MDK16-AWG	Analog Waveform Generator, dual summed 14 bit DACs, 100 Msps.				X		
MDK-QVGA-LCD	Quarter VGA LCD Display Adaptor, LVDS interface.						X