

CS-E9302 development board

Users Manual

Rev.A, July 2008

Copyright(c) 2008, OLIMEX Ltd, All rights reserved

INTRODUCTION:

CS-E9302 is powerful development board for 200MHz Cirrus Logic EP9302 ARM920T microprocessors with two USB hosts, two RS232 ports, 100Mbit Ethernet, SD-MMC card, 16MB NOR Flash, 32MB SDRAM, IrDA transceiver, JTAG, UEXT, EXT, ADC connectors for additional peripherals.

BOARD FEATURES:

- MCU: EP9302 ARM920T 200Mhz, 16+16KB instruction and data cache, MMU, SDRAM, SRAM, FLASH external bus controller 100Mhz bus, 100Mbit Ethernet MAC, two UARTS, two USB 2.0 ports, IrDA, ADC, SPI, I2S Audio, AC97, DMA 12 ch, RTC, dual PLL, WDT, 2- 16 bit, 1- 32 bit TIMERS, boot ROM, interrupt controller;
- External SDRAM 32MB (16MB x16bit) 7.5 ns /133MHz;
- External Flash 16MB (8MB x16 bit) 80 ns;
- ETHERNET 10/100 PHY KS8721BL;
- 2 x RS232 drivers and connectors;
- 2 x USB host connectors;
- SD/MMC card;
- IrDA transceiver on board;
- UEXT connector with I2C, SPI, RS232 and power supply for connecting add-on modules like RF link, MP3, etc available from Olimex;
- JTAG interface;
- ADC extension port;
- Power supply plug in jack;
- [Linux 2.4](#), [Linux 2.6](#) and [NetBSD](#) sources and pre-build images ready to load with Redboot are available on the supplement CD;
- Dimensions: 110x90 mm (4.3 x 3.5").

ELECTROSTATIC WARNING:

The CS-E9302 development board is shipped in protective anti-static packaging. The board must not be subject to high electrostatic potentials. General practice for working with static sensitive devices should be applied when working with this board.

BOARD USE REQUIREMENTS:

- Cables:** Two DB9 female-female null modem type for connection with serial COM port of PC host.
Crossed LAN cable for connection with PC or straight LAN cable for connection with switch or router.
- Hardware:** +5V/1A regulated power source.
ARM-JTAG, ARM-USB-OCD, ARM-USB-TINY or other compatible tool only if you want to develop with JTAG, usually with the pre-loaded linux RTOS this is not necessary.
- Software:** The boards are delivered pre-loaded with Linux 2.6.

PROCESSOR FEATURES:

The EP9302 system-on-chip processor has the following features:

- 200 MHz ARM920T Processor
 - 16 KByte data cache and 16 KByte instruction cache
 - MMU enabling Linux® and Windows® CE
 - 100 MHz system bus
- MaverickKey™ IDs for Digital Rights Management or Design IP Security
 - 32-bit unique ID
 - 128-bit random ID
- Integrated Peripheral Interfaces
 - 1/10/100 Mbps Ethernet MAC
 - Two-port USB 2.0 Full Speed host (OHCI)
 - Two UARTs (16550 Type)
 - IrDA interface, slow and fast mode
 - Analog-to-Digital Converter (ADC)
 - Serial Peripheral Interface (SPI) port
 - AC '97 interface
 - I2S interface, up to 2 channels
- External Memory Options
 - 16-bit SDRAM interface, up to four banks
 - 16/8-bit SRAM/Flash/ROM interface (I/F)
 - Serial EEPROM interface
- Internal Peripherals
 - Real-Time clock with software trim
 - 12 DMA channels for data transfer that maximizes system performance
 - Boot ROM
 - Dual PLLs control all clock domains
 - Watchdog timer
 - Two general purpose 16-bit timers
 - General purpose 32-bit timer
 - 40-bit debug timer
- General-Purpose I/Os
 - 16 enhanced GPIOs including interrupt capability
 - 31 additional optional GPIOs multiplexed on peripherals.

EP9302 BLOCK DIAGRAM

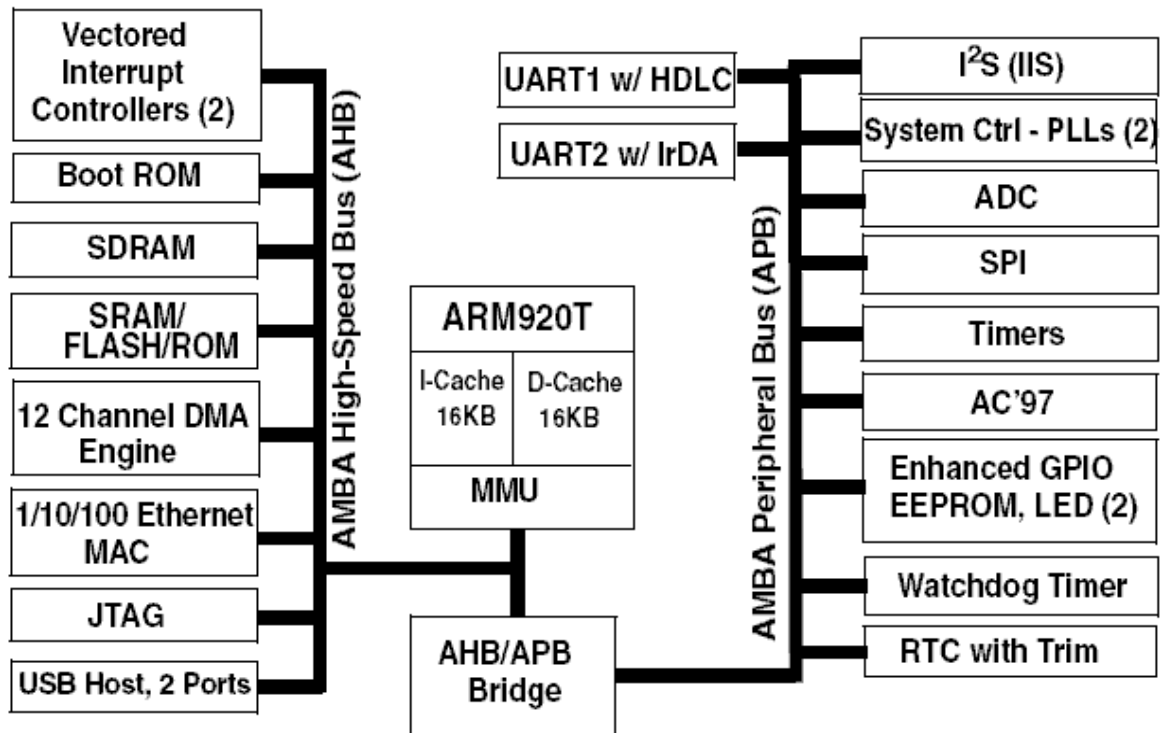

MEMORY MAP:

Address Range	Sync Memory Boot	Async Memory Boot
	ASD0 Pin = 1	ASD0 Pin = 0
0xF000_0000 – 0xF200_0000 (32MB on board SDRAM)	Async memory (nCS0)	Sync memory (nSDCE3)
0xE000_0000 - 0xEFFF_FFFF	Sync memory (nSDCE2)	Sync memory (nSDCE2)
0xD000_0000 - 0xDFFF_FFFF	Sync memory (nSDCE1)	Sync memory (nSDCE1)
0xC000_0000 - 0xCFFF_FFFF	Sync memory (nSDCE0)	Sync memory (nSDCE0)
0x9000_0000 - 0xBFFF_FFFF	Not Used	Not Used
0x8080_0000 - 0x8FFF_FFFF	APB mapped registers	APB mapped registers
0x8010_0000 - 0x807F_FFFF	Reserved	Reserved
0x8000_0000 - 0x800F_FFFF	AHB mapped registers	AHB mapped registers
0x7000_0000 - 0x7FFF_FFFF	Async memory (nCS7)	Async memory (nCS7)
0x6000_0000 – 0x6100_0000 (16MB on board NOR flash)	Async memory (nCS6)	Async memory (nCS6)
0x5000_0000 - 0x5FFF_FFFF	Reserved	Reserved
0x4000_0000 - 0x4FFF_FFFF	Reserved	Reserved
0x3000_0000 - 0x3FFF_FFFF	Async memory (nCS3)	Async memory (nCS3)
0x2000_0000 - 0x2FFF_FFFF	Async memory (nCS2)	Async memory (nCS2)
0x1000_0000 - 0x1FFF_FFFF	Async memory (nCS1)	Async memory (nCS1)
0x0001_0000 - 0x0FFF_FFFF	Sync memory (nSDCE3)	Async memory (nCS0)

SCHEMATIC:

CS-E9302 REV.B

COPYRIGHT © 2007, OULTEK LTD.
HTTP://WWW.OULTEK.COM/DCU

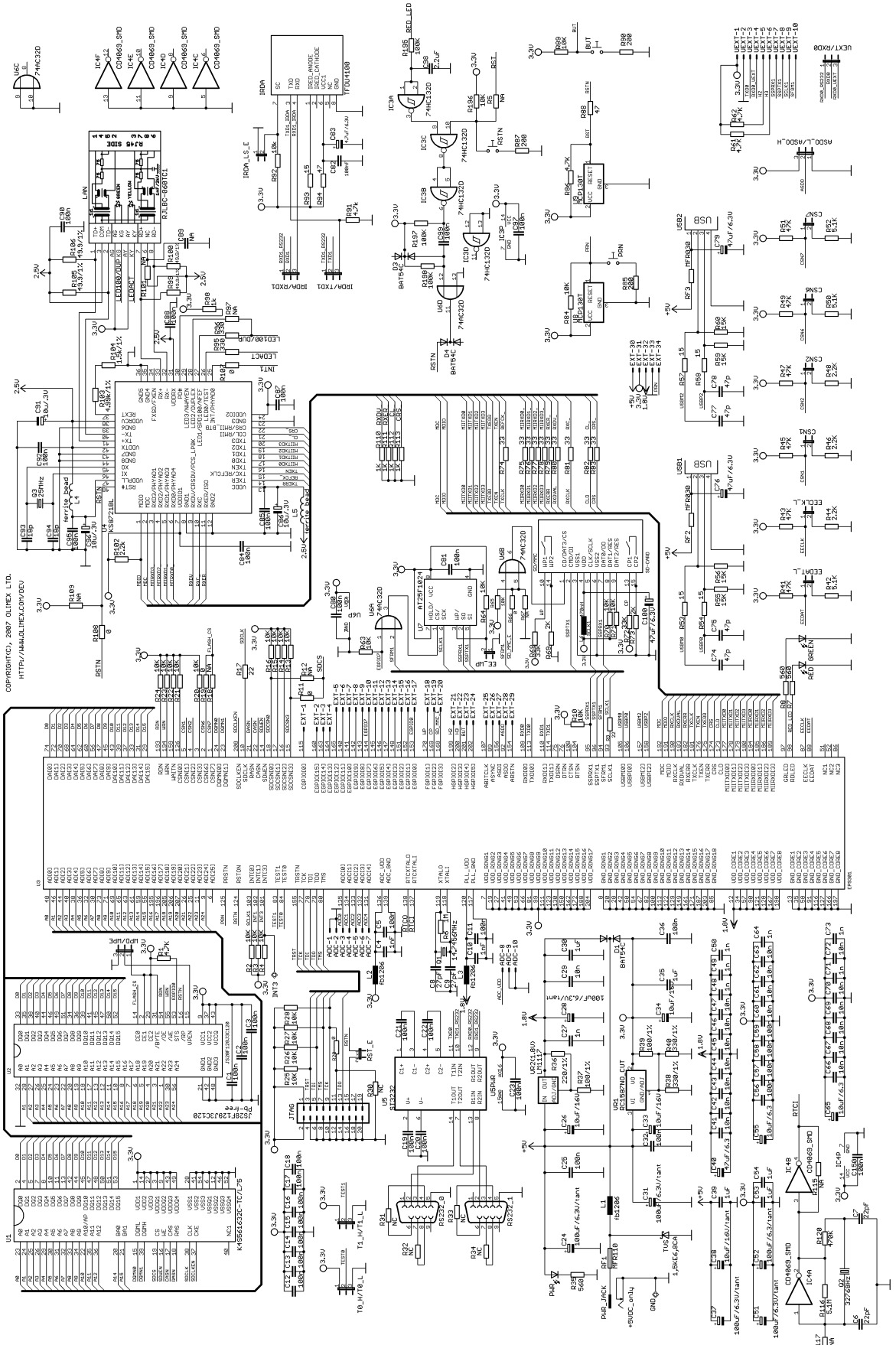

BOARD LAYOUT:

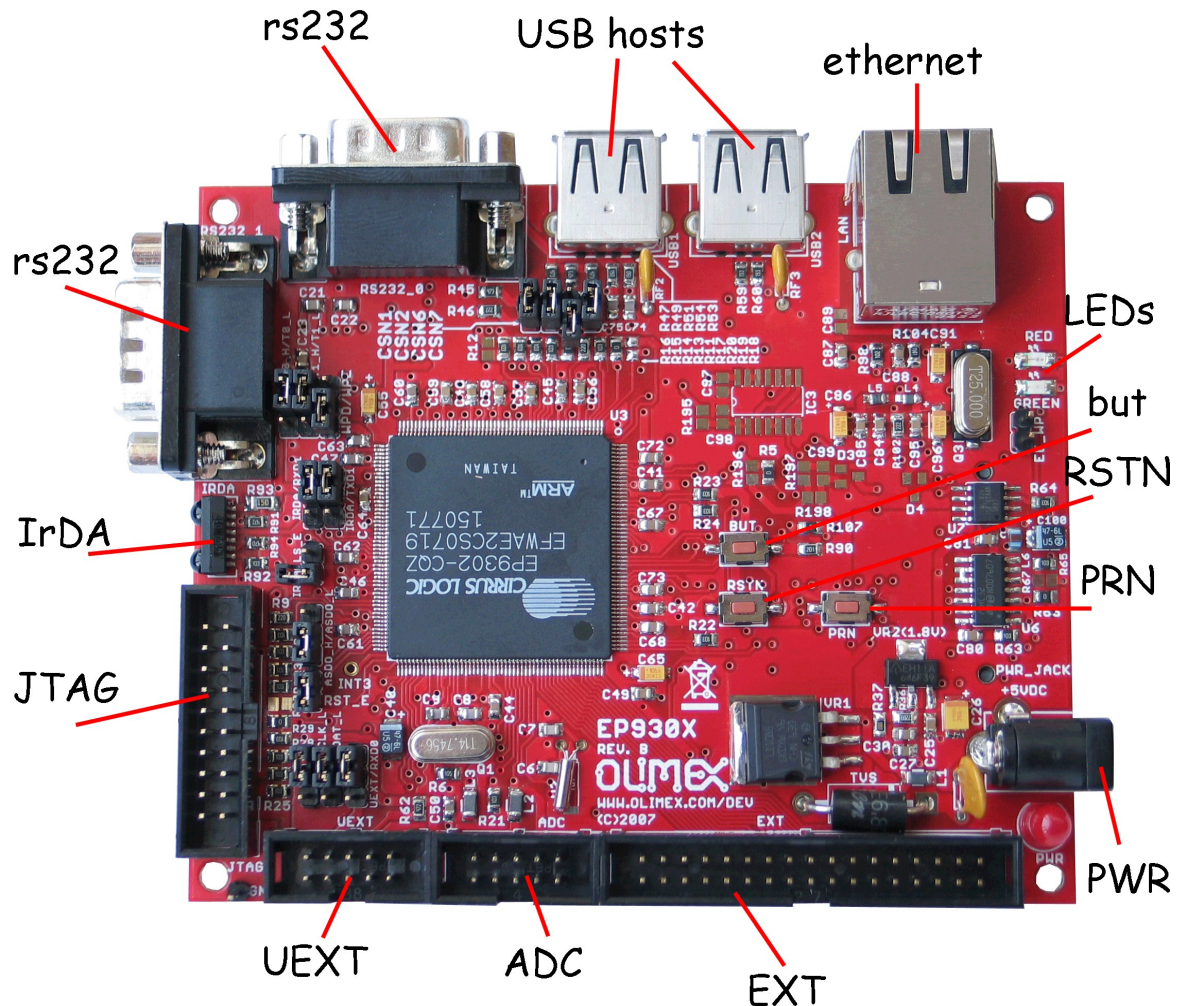

POWER SUPPLY CIRCUIT:

CS-E9302 power supply should be 5V regulated, please do not use other than 5V power supply as the power line goes to the USB hosts and if you apply power supply above 5V this will destroy your USB devices. The PWR_JACK inner pin is positive.

The board power consumption is about 400-450 mA with 200 MHz CPU clock and 100MHz system bus.

RESET CIRCUIT:

The EP9302 chip can be reset through the PRSTN pin(power on reset) or through the open drain common reset pin(user reset) - RSTON pin.

PRSTN is a Power-on Reset realized with MCP130T Reset circuit with typical 2.9V threshold. On the board is present a PRN button which is used for manual Power-on Reset.

The user reset – RSTON is common for the CS9203 microcontroller, PHY chip, NOR flash, JTAG and MCP130 Supervisory circuit. It can be generated from JTAG pin(15), RSTN button, CS9302 or MCP130T Reset circuit.

CLOCK CIRCUIT:

EP9302 generates its internal clock with PLL and uses single 14.7456 MHz crystal connected to EP9302 pin 119 (XTAL0) and pin 118 (XTAL1).

The Real Time Clock operates from a 32.768 KHz crystal.

JUMPER DESCRIPTION:

Boot configuration jumpers:

The Hardware Configuration controls are defined by a set of device pins that are latched into configuration control bits on the assertion of chip reset on the rising edge of the PRSTN or RSTON pin. The different hardware configuration bits define watchdog behavior, boot mode (internal or external), boot synchronicity, and external boot width. The latched pins are:

- EECLK** – Select internal or external boot
The corresponding jumper is EECLK_L. When the jumper is closed EECLK pin is log. “0”, otherwise – log.”1”.
- EEDAT** – Should be pulled up to “1”
The corresponding jumper is EEDAT_L. When the jumper is closed EEDAT pin is log. “0”, otherwise – log.”1”.
- TEST[1:0]** – Select boot mode
The corresponding jumpers are T0_H/T0_L and T1_H/T1_L
When the T0_H/T0_L jumper is closed to T0_H side TEST0 pin is “1”. When the T0_H/T0_L jumper is closed to T0_L side TEST0 pin is “0”.
When the T1_H/T1_L jumper is closed to T1_H side TEST1 pin is “1”. When the T1_H/T1_L jumper is closed to T1_L side TEST1 pin is “0”.

ASDO

– Select synchronous or asynchronous boot
 The corresponding 3 pin jumper is ASDO_H/ASDO_L. If the jumper is closed to ASDO_H side – ASDO pin is log. “1”.
 The Other side is log. “0”.

CSN[7:6]

– Select external boot width.
 CSN6 and CSN7 are the jumpers which define logical level of these pins. If the jumpers are closed – the corresponding pin is “0”.

EECLK	EEDAT	TEST1	TEST0	ASDO	CSN[7:6]	Boot Configuration
0	1	0	0	1	00 01	External boot from Sync memory space selected by DevCfg3 through the SDRAM Controller. The media type must be either SRAM or SyncFLASH. The selection of the SRAM width is determined by latched CSN[7:6] value: 8-bit SFLASH 16-bit SRAM
0	1	0	0	0	00 01	External boot from Async memory space selected by nCS0 through Synchronous Memory Controller. The selection of the SRAM width is determined by latched CSN[7:6] value: 8-bit SRAM 16-bit SRAM
1	1	0	1	X	01	16-bit SERIAL BOOT
<i>1</i>	<i>1</i>	<i>0</i>	<i>0</i>	<i>1</i>	<i>00 01</i>	<i>Boot from external NOR-FLASH. The selection of the bus width is determined by latched CSN[7:6] value: 8-bit 16-bit – DEFAULT POSITION – NORMAL BOOT</i>
1	1	0	0	0	00 01	Internal boot from on-chip ROM. The selection of the ROM width is determined by latched CSN[7:6] value: 8-bit 16-bit

Only two selections are functional for the user, Normal Boot and Serial Boot. The other modes are reserved for factory use only.

The BLUE table line is the default boot position.

Watchdog configuration jumpers:**CSN1**

- Disable Watchdog reset timer
 If the CSN1 jumper is closed the corresponding pin (CSN1) is “0”, otherwise – “1”.

CSN2

- Disable Watchdog reset duration
 If the CSN2 jumper is closed the corresponding pin (CSN2) is “0”, otherwise – “1”.

CSN1	CSN2	Startup Option
0	0	<i>Watchdog Disabled; Reset Duration Disabled</i>
0	1	Watchdog Disabled; Reset Duration Active
1	0	Watchdog Active; Reset Duration Disabled
1	1	Watchdog Active; Reset Duration Active

The BLUE table line is the default boot position.

WPD/WPE



The WPD/WPE jumper defines Write protected state of NOR-FLASH U2(JS28F128J3C120) WPD state (1-2 shorted) enables flash write, WPE state (2-3 shorted) disables flash write.

Default position is 1-2 shorted.

EE_WP



When the EE_WP jumper is , it closed disables U7(AT25F1024) EEPROM write.

Default position is open.

IRDA/RXD1



The IRDA/RXD1 jumper defines RXD1(pin 110 of MCU) connection. When the jumper is installed in IRDA state (2-3 shorted), then the RXD1 function of MCU is connected to IRDA module. If RXD1 state is selected (1-2 shorted), RXD1 pin is connected through RS232 driver U5 to RS232_1 connector.

Default position is 1-2 shorted.

IRDA/TXD1



The IRDA/TXD1 jumper defines TXD1(pin 114 of MCU) connection. When the jumper is installed in IRDA state (2-3 shorted), then TXD1 function of MCU is connected to IRDA module. If TXD1 state is selected (1-2 shorted), TXD1 pin is connected through RS232 driver U5 to RS232_1 connector.

Default position is 1-2 shorted.

IRDA_LS_E



IRDA_LS_E jumper is used if Low Speed mode of IRDA chip must be selected. When the jumper is closed, the user enables Low Speed mode.

Default position is open.

RST_E When the RST_E jumper is closed, pin15 of JTAG connector is tied to RSTN (User Reset) line or allows JTAG resetting.
 connector is tied to RSTN (User Reset) line or allows JTAG resetting.
Default position is closed.

UEXT/RXD0 The UEXT/RXD0 jumper defines RXD0(pin 109 of MCU) connection. When the jumper is installed in UEXT state, then the RXD0 function of MCU is connected to the UEXT connector. If RXD0 state is selected, RXD0 pin is connected through RS232 driver U5 to RS232_0 connector.
 state, then the RXD0 function of MCU is connected to the UEXT connector. If RXD0 state is selected, RXD0 pin is connected through RS232 driver U5 to RS232_0 connector.
Default position is 1-2 shorted.

INPUT/OUTPUT:

Two **reset buttons** with names **RSTN** and **PRN** – connected to EP9302 chip pin 124 (RSTON) and pin 125 (PRSTN).

One **user button** with name **BUT** – connected to EP9301 pin 201 HGPIO[4].

Two **LEDs** – RED – connected to EP9301 pin 98 RDLED and GREEN – connected to EP9301 pin 97 GRLED.

Power supply red LED with name **PWR** – indicates that power supply is present.

CONNECTOR DESCRIPTIONS:

USB1, USB2:

USB1		USB2	
Pin #	Signal Name	Pin #	Signal Name
1	+5V	1	+5V
2	USBM0	2	USBM2
3	USBP0	3	USBP2
4	GND	4	GND

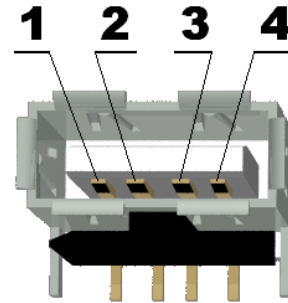

USBM0 and **USBP0** form the differential input/output of the USB host 0.
USBM1 and **USBP1** form the differential input/output of the USB host 1.

The USB Open Host Controller Interface (Open HCI) provides full speed serial communications ports at baud rate of 12 Mbits/sec. Up to 127 USB devices (printer, mouse, camera, keyboard, etc.) and USB hubs can be connected to the USB host in the USB “tieredstart” topology. The USB port is compliance with the USB 2.0 specification and supports both low speed (1.5 Mbps) and full speed (12 Mbps) USB device connections.

RS232 0, RS232 1:

UART0 supports modem bit rates up to 115.2 K. 16 byte FIFO for receive and a 16 byte FIFO for transmit is available at the RS232_0 DB9 male connector. The data bits, no parity, 1 stop bit, no flow control.

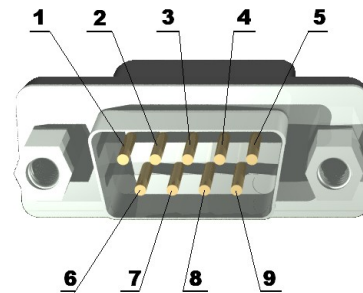

es a
 z OS
 is, 8

UART1 contains an IrDA encoder operating at either the slow (up to 115 Kbps), medium (0.576 or 1.152 Mbps), or fast (4 Mbps) IR data rates. It also has a 16 byte FIFO for receive and a 16 byte FIFO for transmit.

RS232_0		RS232_1	
Pin #	Signal Name	Pin #	Signal Name
1	NC	1	NC
2	RXD_0	2	RXD_1
3	TXD_0	3	TXD_1
4	pin 6	4	pin 6
5	GND	5	GND
6	pin 4	6	pin 4

7	pin 8	7	pin 8
8	pin 7	8	pin 7
9	NC	9	NC

TXD_0 Output **Transmit Data 0.** This is the asynchronous serial data output (RS232) for the shift register on the UART0 controller. (This pin is input for the RS232 and input for the LPC2478)

RXD_0 Input **Receive Data 0.** This is the asynchronous serial data input (RS232) for the shift register on the UART0 controller. (This pin is output for the RS232 and input for the LPC2478)

TXD_1 Output **Transmit Data 1.** This is the asynchronous serial data output (RS232) for the shift register on the UART1 controller. (This pin is input for the RS232 and input for the LPC2478)

RXD_1 Input **Receive Data 1.** This is the asynchronous serial data input (RS232) for the shift register on the UART1 controller. (This pin is output for the RS232 and input for the LPC2478)

ETHERNET:

The CS-E9302 is shipped with a complete physical and MAC subsystem. The EP9302 supports 1/10/100 Mbps transfer rates. The MAC subsystem is compliant with the ISO/TEC 802.3 topology for a single shared medium with several stations. Multiple MII-compliant PHYs are supported. The PHY layer is realized with MICREL PHY chip KS8721BL.

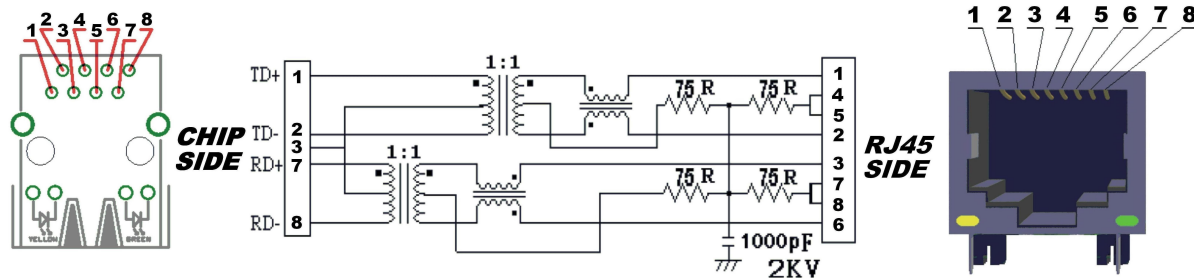

Pin #	Signal Name Chip Side	Pin #	Signal Name Chip Side
1	TD+	5	NC
2	TD-	6	2.5V
3	2.5V	7	RD+
4	NC	8	RD-

LED	Color	Usage
Right	Yellow	Activity

Left	Green	100Mbits/s (Half/Full duplex)

- TD-** OutputDifferential signal output. This signal is output from the MCU.
- TD+** OutputDifferential signal output. This signal is output from the MCU.
- RD-** Input Differential signal input. This signal is input for the MCU.
- RD+** InputDifferential signal input. This signal is input for the MCU.

UEXT:

Pin #	Signal Name	Pin #	Signal Name
1	3.3V	2	GND
3	TXD0	4	RXD0_UEXT
5	H2	6	H3
7	SSPRX1	8	SSPTX1
9	SCLK1	10	SFRM1

UEXT is a universal OLIMEX connector with 3.3V power supply and UART, SPI interface + MCU HGPIO[2] and HGPIO[3] port connected to UEXT pin 5 and pin 6. Other device or modules with these interfaces can be connected with UEXT. For example:
 MOD-NRF24L - <http://www.olimex.com/dev/mod-nrf24L.html>
 MOD-RFID125- <http://www.olimex.com/dev/mod-rfid125.html>
 MOD-MP3 - <http://www.olimex.com/dev/mod-mp3.html>

ADC:

Pin #	Signal Name	Pin #	Signal Name
1	GND	2	GND
3	ADC0	4	ADC1
5	ADC2	6	ADC3
7	ADC4	8	ADC_VDD(3.3V)
9	GND	10	GND

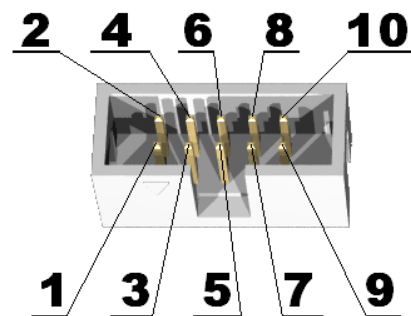

The ADC block consists of a 12-bit Analog To Digital converter with a analog input multiplexer. The multiplexer can select to measure battery voltage and other miscellaneous voltages on the external measurement pins. Signal should be in range: 0 to 3.3 V, ADC complete may issue interrupts.

SD/MMC CARD INTERFACES

Pin #	Signal Name
1	CD_MMC_E/SFRM1
2	SSPTX1
3	GND
4	VCC (470nH to 3.3V)
5	SCLK1
6	GND
7	SSPRX1
8	10K to VCC
9	10K to VCC
10	WP (33K to VCC)
11	WP (2K to GND)
12	CP (2K to GND)
13	WP (33K to VCC)
14	2K to GND
15	2K to GND

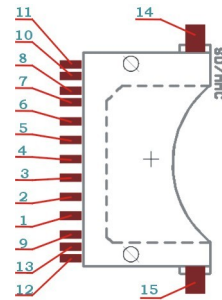

EXT:

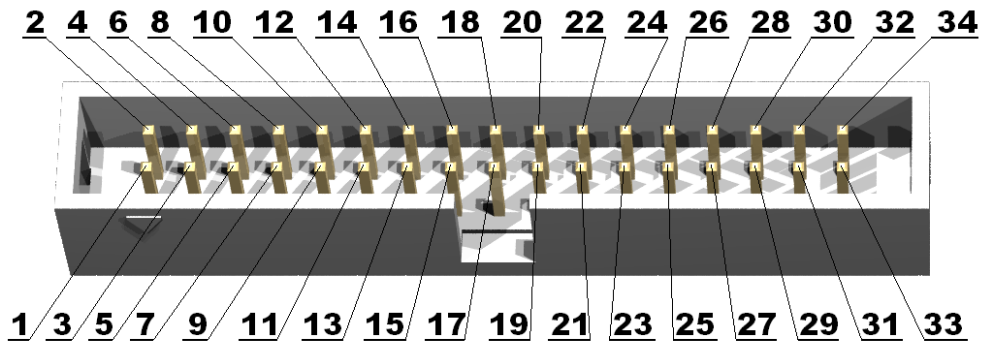

Pin #	Signal Name	Pin #	Signal Name
1	CGPIO[0]	2	EGPIO[15]
3	EGPIO[14]	4	EGPIO[13]
5	EGPIO[12]	6	EGPIO[11]
7	EGPIO[10]	8	EGPIO[9]
9	EGPIO[8]	10	EGPIO[7]
11	EGPIO[6]	12	EGPIO[5]
13	EGPIO[4]	14	EGPIO[3]
15	EGPIO[2]	16	EGPIO[1]
17	EGPIO[0]	18	FGPIO[1]
19	FGPIO[2]	20	FGPIO[3]
21	HGPIO[2]	22	HGPIO[3]
23	HGPIO[4]	24	HGPIO[5]
25	ABITCLK	26	ASYNC
27	ASDI	28	ASDO
29	ARSTN	30	+5V(Out)
31	3.3V(Out)	32	1.8V(Out)
33	GND	34	PRN(Power on Reset)

On this connector are available all GPIOs of EP9302 which are not used for other purposes. With them you can make add-on modules to control with CS-E9302 like GSM/GPS, input/output add-on boards.

JTAG:

The JTAG connector allows the software debugger to talk via a JTAG (Joint Test Action Group) port directly to the core. Instructions may be inserted and executed by the core thus allowing MCU memory to be programmed with code and executed step by step by the host software.

For more details refer to IEEE Standard 1149.1 - 1990 Standard Test Access Port.

Pin #	Signal Name	Pin #	Signal Name
1	+3.3V	2	+3.3V
3	TRST	4	GND
5	TDI	6	GND
7	TMS	8	GND
9	TCK	10	GND
11	TCK/GND	12	GND
13	TDO	14	GND
15	RSTN/NC	16	GND
17	NC	18	GND
19	NC	20	GND

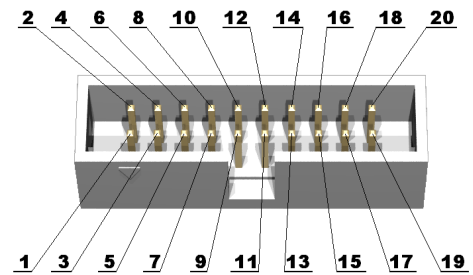

TDI Input **Test Data In**. This is the serial data input for the shift register.

TDO Output **Test Data Out**. This is the serial data output for the shift register. Data is shifted out of the device on the negative edge of the TCK signal.

TMS Input **Test Mode Select**. The TMS pin selects the next state in the TAP state machine.

TCK Input **Test Clock**. This allows shifting of the data in, on the TMS and TDI pins. It is a positive edge triggered clock with the TMS and TCK signals that define the internal state of the device.

TRST Input **Test Reset**. This signal resets the JTAG controller.

TCK Output **Clock**. This is a synchronization signal which the JTAG connector uses to acknowledge it is ready to receive/transmit.

RSTN Input **Reset**. This signal resets the MCU.

This connector shares the ARM default JTAG layout.

PWR:

Pin #	Signal Name
1	+5VDC ONLY
2	GND

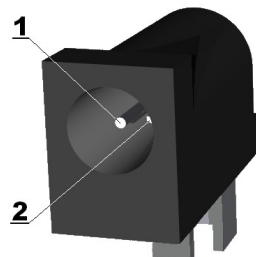

Note: Apply only 5V DC regulated voltage!

MECHANICAL DIMENSIONS:

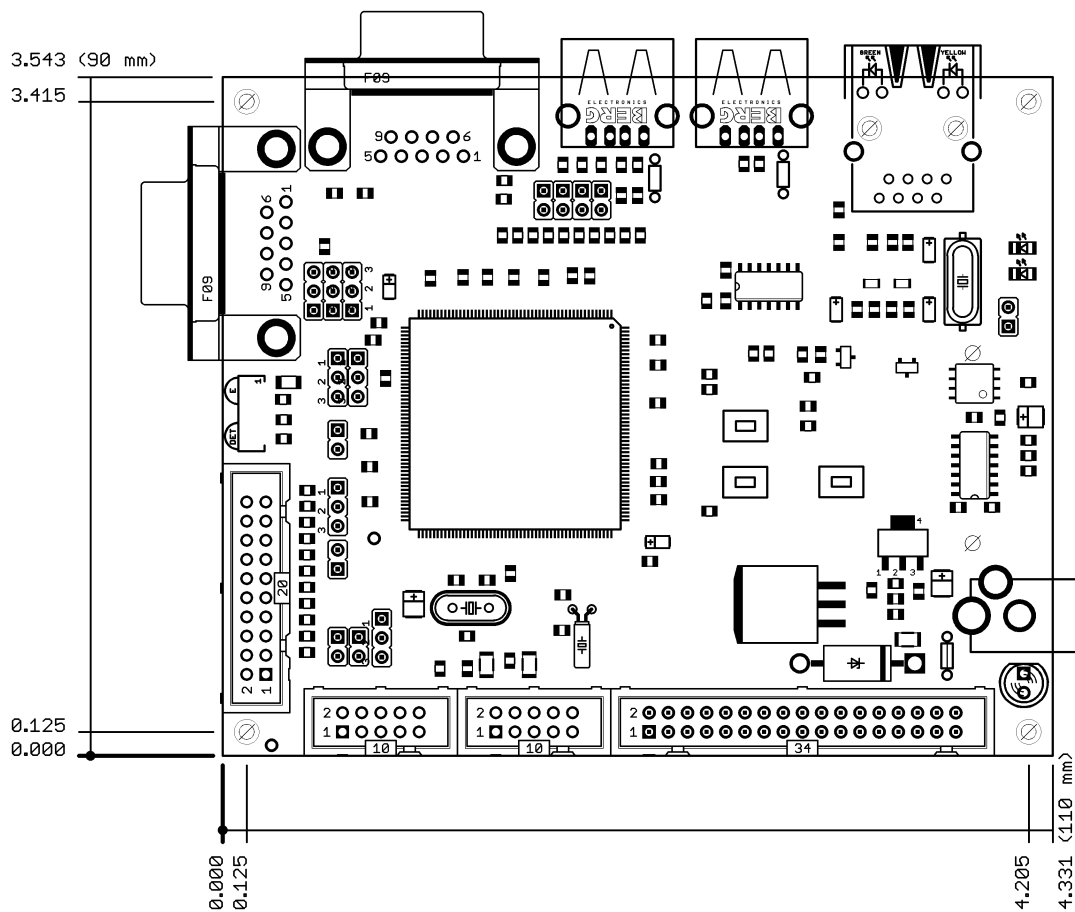

All measures are in mm.

SOFTWARE:

CS-E9302 is distributed with CD with Linux 2.4, NetBSD and Linux 2.6 sources and pre-build images for Linux 2.4, Linux 2.6 and NetBSD.

The boards are pre-loaded with Linux 2.6 in the internal flash.

The software for CS-E9302 could be developed and debugged on desktop computer then cross-compiled and loaded in the board. Here below is example how to cross compile "Hello world" program. In most of the cases you do not need JTAG as on the other embedded systems which do not have RTOS (how often do you develop on your Pentium desktop computer with JTAG?), but for case where peoples want to blink LEDs without RTOS we have provided the JTAG connector as well.

Cross-compiling a simple "hello world" example:

Extract one of the provided cross-compilers on your host system and add it to the PATH variable. Use the cross-compiler to build the example, then transfer it to the board by e.g. USB flash drive, http download etc.

```
Example commands:
----- On the host system -----
# cd /usr/local/arm
# tar xjf arm-linux-gcc-4.1.1-920t.tar.bz2
...
$ PATH=$PATH:/usr/local/arm/4.1.1-920t/bin
$ cat > hello.c
#include <stdio.h>
int main(void)
{
    unsigned int i;
    printf("\r\nProba proba ");
    for (i=0; i<10; i++)
        printf("\r\n%d", i);
    return 0;
}
^D
$ arm-linux-gcc -o hello hello.c
$ cp hello ~/htdocs/
----- On the board -----
~ # wget http://192.168.0.xx/hello
~ # chmod 777 hello
~ # ./hello
Proba proba
0
1
```

ORDER CODE:

CS-E9302 - assembled and tested (no kit, no soldering required)

How to order?

You can order to us directly or by any of our distributors.

Check our web www.olimex.com/dev for more info.



All boards produced by Olimex are RoHS compliant

Revision history:

REV.A - created July 2008

Disclaimer:

© 2008 Olimex Ltd. All rights reserved. Olimex®, logo and combinations thereof, are registered trademarks of Olimex Ltd. Other terms and product names may be trademarks of others.

The information in this document is provided in connection with Olimex products. No license, express or implied or otherwise, to any intellectual property right is granted by this document or in connection with the sale of Olimex products.

Neither the whole nor any part of the information contained in or the product described in this document may be adapted or reproduced in any material from except with the prior written permission of the copyright holder.

The product described in this document is subject to continuous development and improvements. All particulars of the product and its use contained in this document are given by OLIMEX in good faith. However all warranties implied or expressed including but not limited to implied warranties of merchantability or fitness for purpose are excluded. This document is intended only to assist the reader in the use of the product. OLIMEX Ltd. shall not be liable for any loss or damage arising from the use of any information in this document or any error or omission in such information or any incorrect use of the product.