

DR-TRC105-DK Development Kit User's Guide



***DR-TRC105-304-DK
DR-TRC105-315-DK
DR-TRC105-345-DK
DR-TRC105-372-DK
DR-TRC105-390-DK
DR-TRC105-403-DK
DR-TRC105-434-DK
DR-TRC105-450-DK***



Introduction

The DR-TRC105 series development kits can be used to evaluate TRC105 radio technology, and to prototype applications that will use the TRC105 RFIC. These development kits include the necessary hardware, firmware and utility software to support efficient TRC105 evaluation and system development. This user's guide covers the following development kits:

Development Kit Part Number	Operating Frequency Range
DR-TRC105-304-DK	303.325 - 307.300 MHz
DR-TRC105-315-DK	310.000 - 319.500 MHz
DR-TRC105-345-DK	342.000 - 348.000 MHz
DR-TRC105-372-DK	365.000 - 380.00 MHz
DR-TRC105-390-DK	382.000 - 398.000 MHz
DR-TRC105-403-DK	402.000 - 407.300 MHz
DR-TRC105-434-DK	418.000 - 434.790 MHz
DR-TRC105-450-DK	447.000 - 451.000 MHz

Table 1 - Development Kit Part Numbers

Each DR-TRC105 development kit contains the following items:

- 2 DR-TRC105 Radio Boards
- 2 DR-TRC103/105 Interface Boards
- 2 Dipole Antennas
- 2 USB 2.0 A/B Cables
- 2 Universal Wall-plug Power Supplies, 4.5 V
- 2 AA Battery Packs
- 4 AA Batteries
- CD Containing:
 - RFIC Design Assistant Software
 - Kit Firmware C Source Code
 - User's Guides

The DR-TRC105 development kits provide the following features:

- Supports TRC105 Evaluation and Application Development
- Facilitates TRC105 Parameter Configuration
- USB or RS232 Interface Options
- Wall-plug Power Supply or Battery Power Options
- Includes Example Firmware and PC Utility Software
- Integrated Firmware Range Test Function
- Up to 200 kb/s RF Data Rate
- Out-of-the-box Operation
- 64-byte Packet Handling
- Compatible with SiLabs C8051F310 Development Tools (sold separately)

DR-TRC105 development kits are designed to facilitate the configuration of all TRC105 transmitter, receiver and interface functions, and to support application firmware and system development. The development kits can be controlled using the RFIC Design Assistant utility software. Two-way communication link testing is also supported by the data terminal program built into the RFIC Design Assistant utility. In addition, a stand alone range test function is included in the radio board firmware to allow roaming range tests. Figure 1 shows a development kit interface board with a radio board installed.

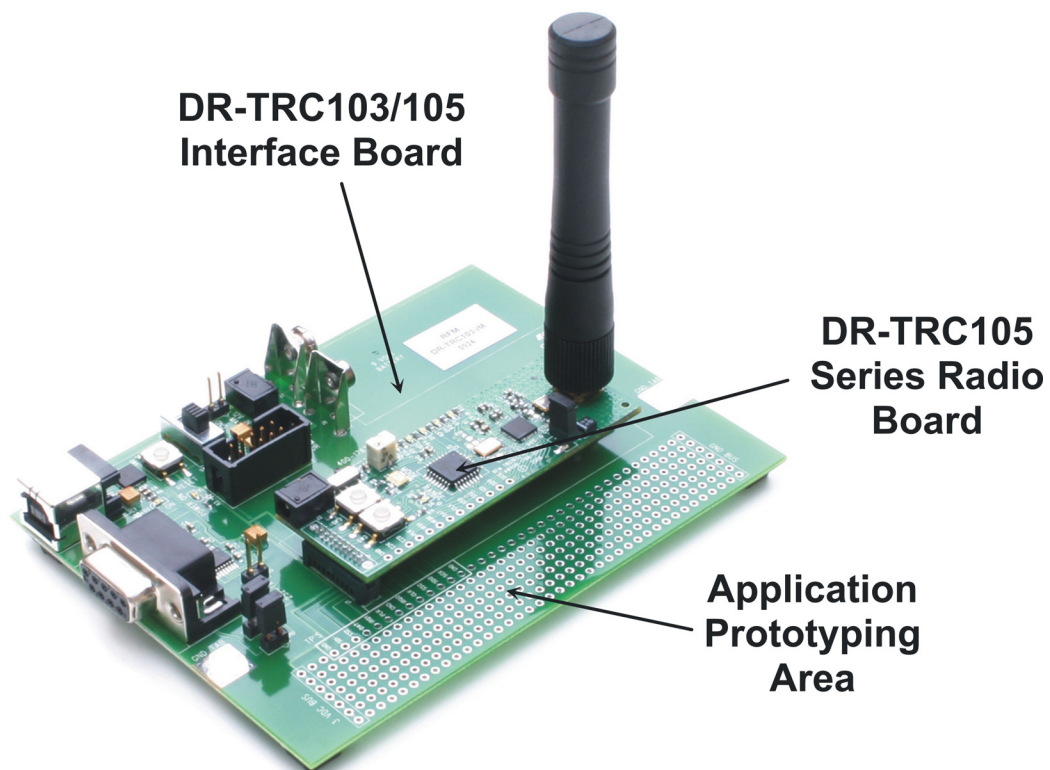

Figure 1 - DR-TRC105-DK Radio and Interface Board Set

The antennas included in each development kit match the operating frequency of the kit, and may be a different length than the 434 MHz antenna shown above. Antennas should always be installed before turning on a radio board.

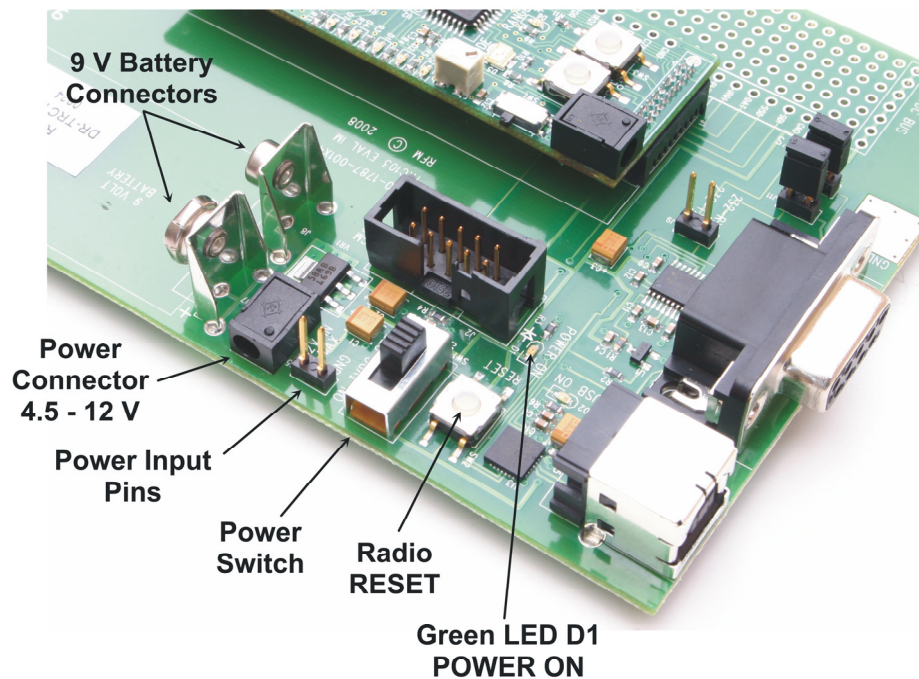

Figure 2 - DR-TRC105-DK Interface Board Connectors and Controls

Figure 2 shows the locations of the interface board DC power connectors, user controls and LED indicators. Normally an interface board is powered from one of the 4.5 volt universal wall-plug power supplies provided in the development kit, as shown in the left panel of Figure 3. For roaming range testing and field testing, the interface board can be powered from a 9 volt battery as shown in the right panel of Figure 3. *Note - do not install a 9 volt battery while the interface board is connected to the wall-plug power supply.* Use only one power source at a time. Power input pins are also provided for connection to a regulated 4.5 to 12 volt lab supply. When connecting to these pins, take care with the polarity. The pin closest to the power connector is the positive input.

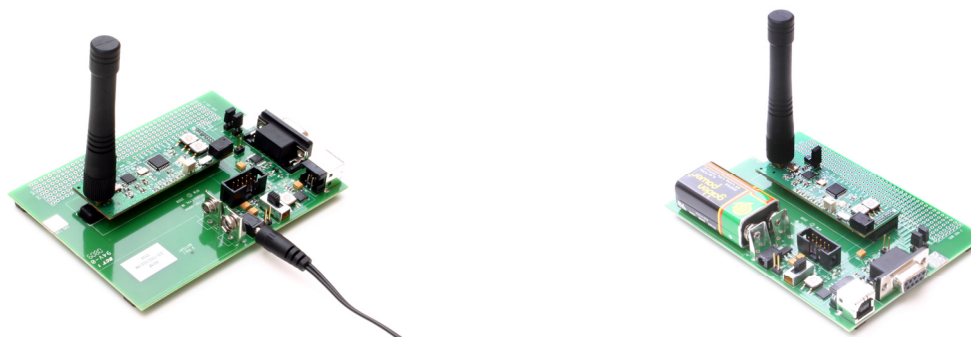

Figure 3 - Power Options

The power switch shown in Figure 2 connects the output of the 3 volt regulator on the interface board to the POWER ON LED, the serial communication interface circuitry and the radio board. Note that there is a small current draw from the regulator when the power switch is in the off position, and this will eventually discharge a 9 volt battery if it is left installed.

The radio RESET button on the interface module allows the user to reset the radio board to a know state from any mode the radio board is in.

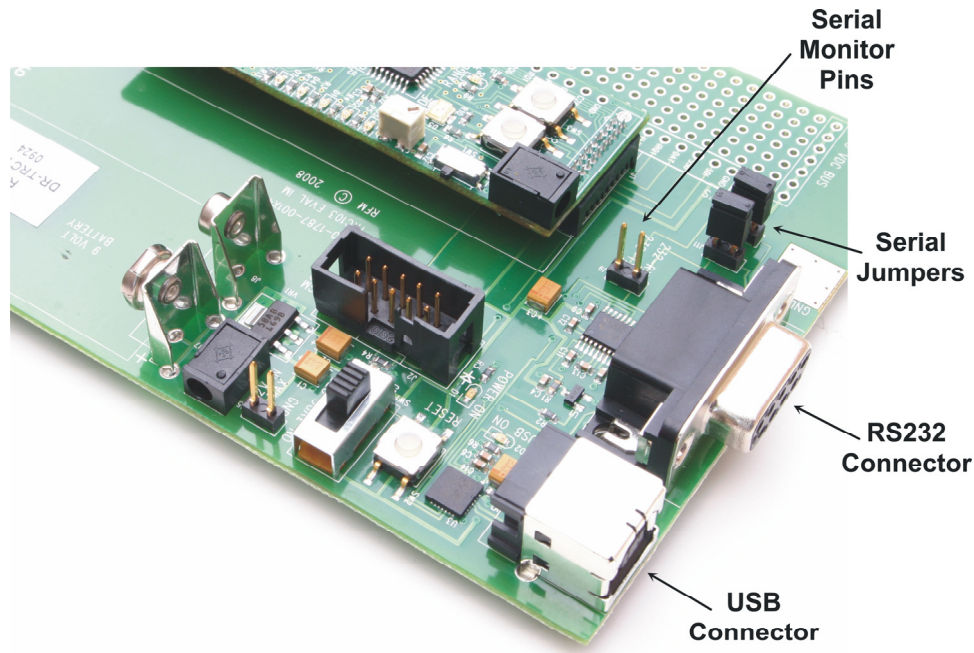

Figure 4 - DR-TRC105-DK Interface Board Serial Connectors

Figure 4 shows the serial communication connectors on the interface board. The kit includes two USB 2.0 A/B cables for connection to a PC. When a USB cable is plugged into an interface board, it automatically disables the RS232 interface circuitry. Note that the interface board is not designed to be powered from the USB interface, so DC power must be supplied separately as discussed above. The kit CD includes the PC drivers needed to make the interface board USB connection appear as a virtual COM port. Refer to the *USB Virtual COM Ports* section of the RFIC Design Assistant User's Guide on the CD for driver installation details.

To configure the interface board for RS232 operation, *remove* the serial jumpers shown in Figure 4. Use a 9-pin "external modem cable" (straight through, not null modem) to connect the interface board to the PC.

The left panel in Figure 5 shows USB operation, the right panel shows RS232 operation. Note the serial jumpers have been removed for RS232 operation.

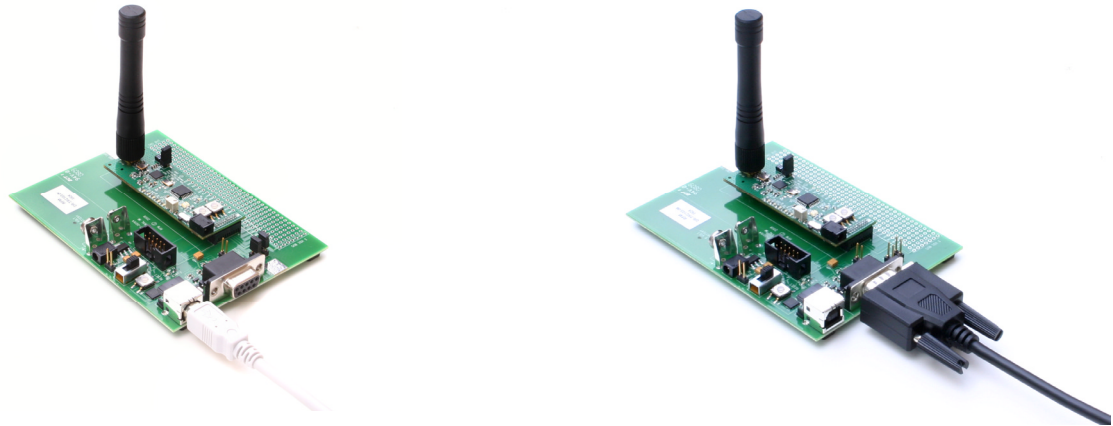

Figure 5 - USB and RS232 Serial Connection Options

Initial Kit Testing Using the Range Test Function

1. Install the antennas and then the 9 volt batteries in both board sets. No PC connection is required for the range test function.
2. Turn on the board sets by sliding the Power switch on the interface board to the ON position. All LED's on the radio board will flash and the MODE LED will be green.
3. See Figure 6 below. On one board, briefly press and release the RANGE button. The RANGE LED will illuminate continuously. This is the "receiving" board.
4. On the other board, press and hold the RANGE button until the LED's begin flashing. This board is the "transmitting" board.
5. If the radios are receiving good packets, then the green Good Packet LEDs will be flashing alternately on each board (plus various yellow LEDs). Figure 10 details the locations of the LEDs.
6. To verify that the radio boards are operating properly, disable the "receiving" board by pressing and releasing the RANGE button twice. The RANGE LED will turn off. On the transmitting board, you should observe the red Packet Error LED flashing. This indicates that the transmitter sent a packet but did not receive an acknowledgment back from the "receiving" radio board.

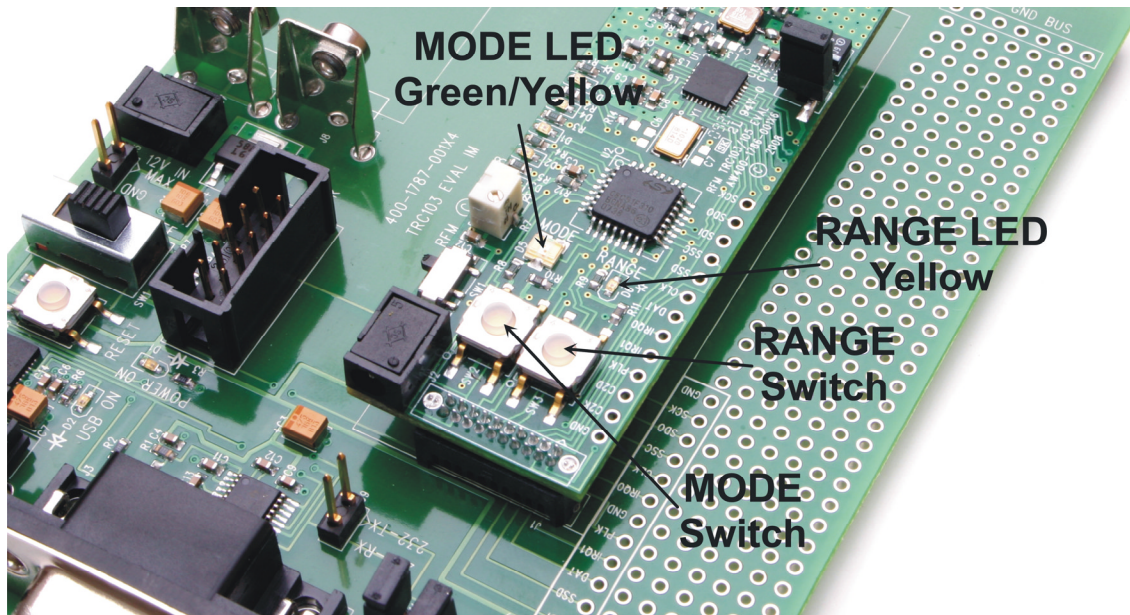

Figure 6 - Initial Testing Using Range Test Function

Kit Testing using the RFIC Design Assistant

1. Install the RFIC Design Assistant utility program from the kit CD. If you are using the USB interface, install the virtual COM port drivers. Refer to the *USB Virtual COM Ports* section of the RFIC Design Assistant User's Guide on the CD for driver installation details.
2. If installed, remove the 9 volt batteries from the board sets. Install the antennas as needed and then connect a 4.5 volt wall-plug power supply to each board set.
3. Connect one of the board sets to the PC. Turn on the board set by sliding the Power switch on the interface board to the ON position. All LED's on the radio board will flash and the MODE LED will be green.
4. Start the RFIC Design Assistant utility program as shown in Figure 7. Select the COM port or virtual COM port assigned to the board set from the drop-down menu at the top of the utility program screen. The COM port can be determined from Windows® as follows: *Start > Settings > Control Panel > System > Hardware > Device Manager > Ports (COM & LPT)*.
5. Select the TRC105 from the TRC drop-down menu as shown in Figure 8. This will launch the TRC105 multi-tab dialog window as shown in Figure 9
6. Select the *Main Menu* tab and click on the *Read Configuration* button. A hex dump of the current TRC105 configuration parameters should appear in the text box above the button as shown in Figure 9. This confirms the development board set is communicating with the utility program. Test the other development kit board set in the same manner. The development kit is now ready to use.

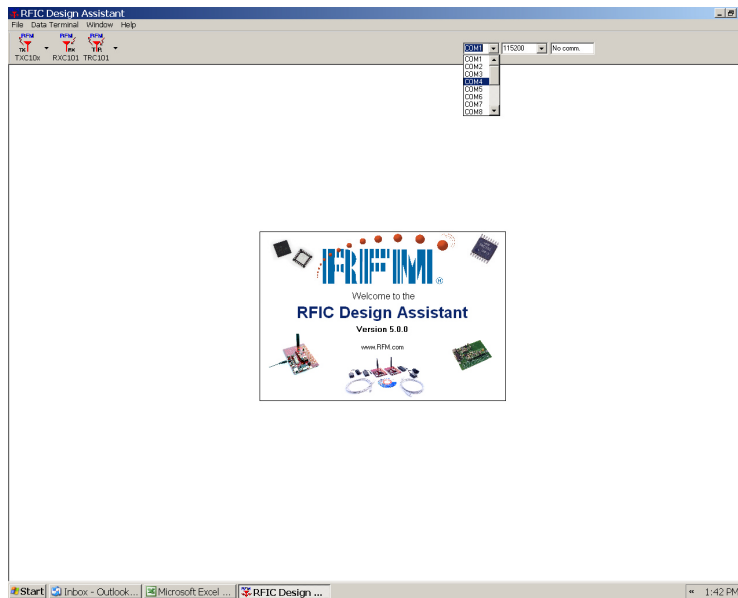

Figure 7 - Starting RFIC Design Assistant

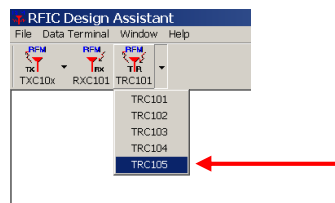

Figure 8 - Selecting TRC105 Operation

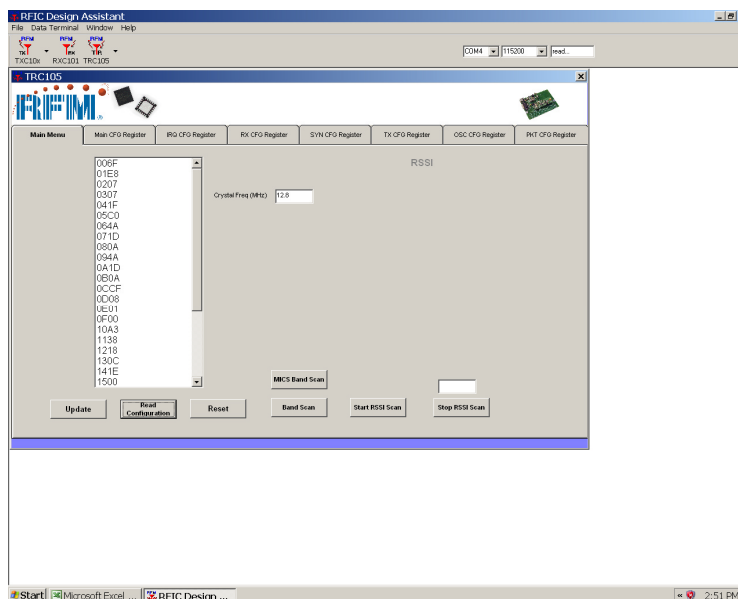

Figure 9 - Read Configuration Test

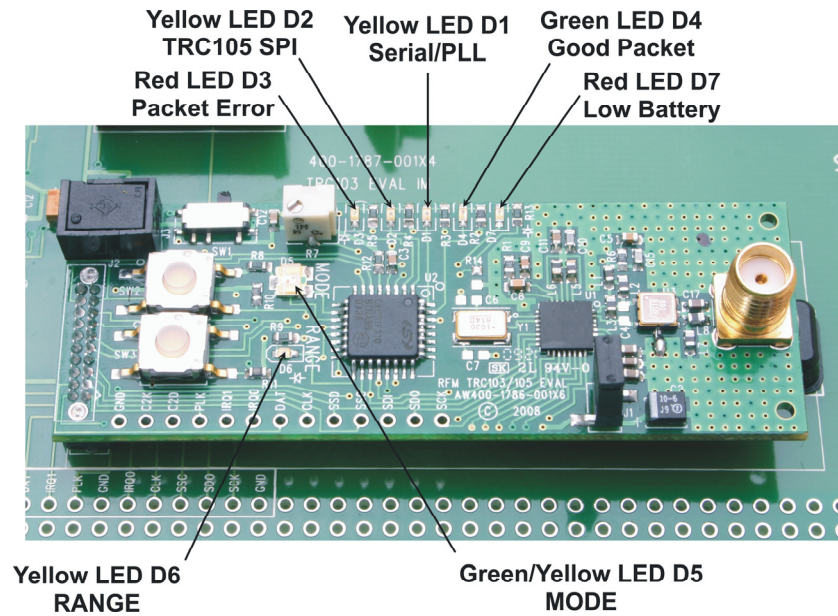

Figure 10 - DR-TRC105 Radio Board LED Indicators

Radio Board Details

The DR-TRC105 radio board LED indicator names and locations are shown in Figure 10. Table 2 summarizes the functions of the DR-TRC105 radio board connectors, user controls and LED indicators.

Component	Designator	Function
I/O Connector	J2	20-pin connector for power and logic signal I/O (bottom of board)
Battery Connector	J3	Radio board “battery” power connector, 2.7 to 3.6 volts
Battery Power Switch	SW1	On/off switch, in line with battery connector
Mode Switch	SW2	Used to set the radio mode
Range Switch	SW3	Used to set up range testing and data terminal functions
TX Power Adj Pot	R7	Transmitter power adjustment potentiometer
Antenna Connector	RF-IO	50 ohm antenna connector, standard SMA
Current Monitor Pins	J1	Remove jumper from these pins to measure TRC105 current
Serial/PLL LED	D1	Yellow LED blinks to indicate serial activity with external host
TRC105 SPI LED	D2	Yellow LED blinks to indicate SPI activity to/from the TRC105
Packet Error LED	D3	Red LED blinks to indicate received packet failed CRC check
Good Packet LED	D4	Green LED blinks to indicate received packet passed CRC check
MODE LED	D5	Green/yellow LED color indicates mode of operation
RANGE LED	D6	Yellow LED blinks to indicate range test or data terminal operation
Low Battery LED	D7	Red LED illuminated to indicate low battery (must be configured)

Table 2 - DR-TRC105 Radio Board Connector, Control and Indicator Functions



When a DR-TRC105 radio board is initially power on, it is configured as follows:

Operating Frequency:

DR-TRC105-304-EV	303.825 MHz
DR-TRC105-315-EV	315.000 MHz
DR-TRC105-345-EV	345.000 MHz
DR-TRC105-372-EV	372.250 MHz
DR-TRC105-390-EV	390.000 MHz
DR-TRC105-403-EV	403.500 MHz
DR-TRC105-434-EV	433.920 MHz
DR-TRC105-450-EV	450.000 MHz

Power: +10 dBm

Frequency Deviation: ± 50 kHz

Data Rate: 25 kb/s

Receiver Baseband Bandwidth: 100 kHz

The radio board is also initially configured in *Receive Continuous Mode* (see the TRC105 datasheet for an explanation of continuous mode, buffered data mode, packet data mode, etc.). In receive continuous mode, the MODE LED will be green. Receive continuous mode allows the user to connect a modulated signal from a signal generator source onto the board through a short, coaxial cable and verify the demodulated signal with an oscilloscope through the DAT pin.

Briefly pressing the MODE button once configures the board into *Transmit Continuous Mode*. The Mode LED will change color from green to yellow. This mode turns on the transmitter. The frequency and output power may be verified on a spectrum analyzer. A square-wave modulating signal may be applied to the DAT pin and modulation observed on the spectrum analyzer.

Briefly pressing the MODE button again configures the board into *Sleep Mode*. The Mode LED will turn off. By connecting an ammeter across the terminals of J1, with the jumper removed, the user can verify the very low sleep current of the TRC105 device.

As shown in Figure 11, potentiometer R7 can be used to adjust the transmit power level. To increase the output power, rotate the potentiometer screw clockwise. To decrease the power, rotate the potentiometer screw counterclockwise. The transmit power is divided into 8 levels. Adjusting R7 adjusts the voltage level to the A-to-D converter (ADC) in the host microcontroller. The microcontroller periodically samples R7 for a change, and updates the transmit power register when it detects a change in voltage level. Each time the microprocessor updates the transmit power register the SPI LED D2 will flash indicating an SPI write.

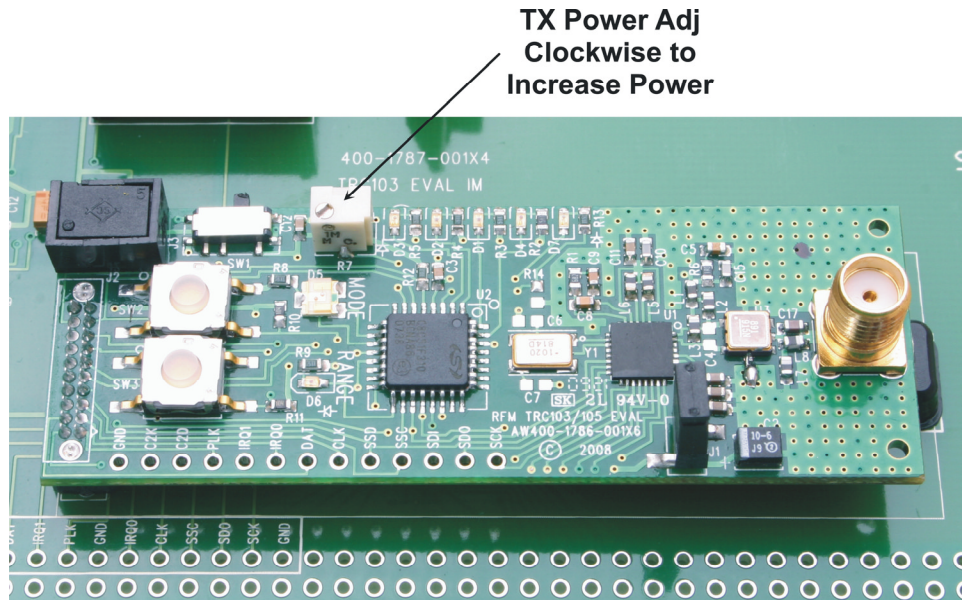

Figure 11 - DR-TRC105 Radio Board TX Power Adjustment

Two AA battery packs are supplied in the development kit to power the radio boards when they are removed from the interface boards, as shown in Figure 12. Alternately, a regulated power supply in the range of 2.7 to 3.6 volts can be used to power the radio boards. Note - there are no voltage regulators on the radio boards. Applying a voltage outside the specified power supply range can damage the boards. Do not attempt to power a radio board directly through its battery connector using one of the 4.5 volt wall-plug power supplies. The 4.5 volt power supplies are used to power the development kit interface boards, which in turn provide regulated 3 volts to the radio boards. The AA battery packs should only be used to power stand alone radio boards. They do not provide enough voltage to reliably power the interface boards. Do not attempt to power a radio board through its battery connector when it is plugged into an interface board.



Figure 12 - Powering the Stand-alone Radio Boards

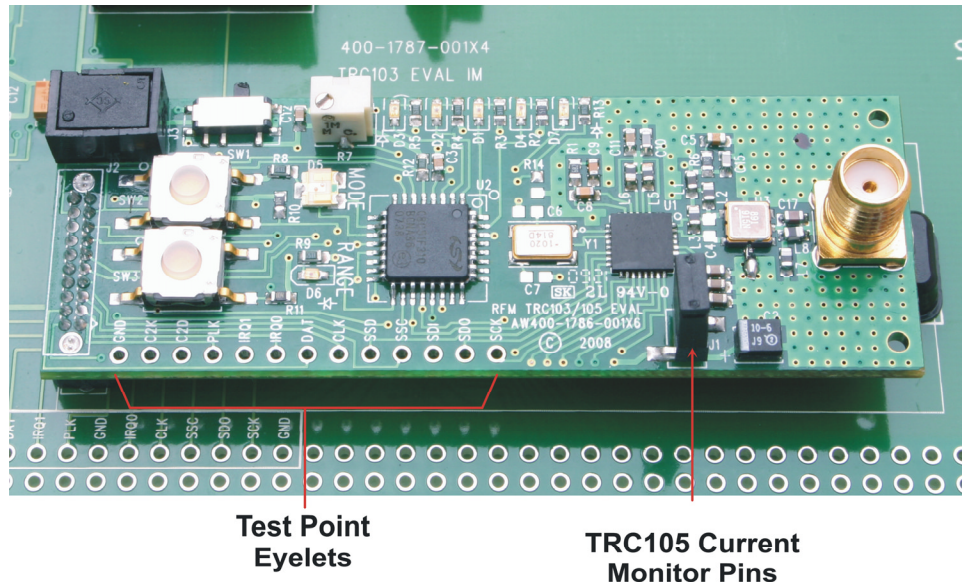

Figure 13 - DR-TRC105 Radio Board Test Points

Referring to Figure 13, test points are provided to monitor signals to/from the TRC105 RFIC in real time. Test point details are listed in Table 3:

PCB Symbol	Function
SCK	SPI clock
SDO	SPI data from TRC105
SDI	SPI data to the TRC105
SSC	SPI configuration select
SSD	SPI data select
CLK	Buffered/divided clock from crystal
DAT	Input/output data (disabled in buffered and packet modes)
IRQ0	Interrupt 0 output
IRQ1	Interrupt 1 output
PLK	PLL lock indicator output
C2D	Processor programming
C2K	Processor programming
GND	Ground
J1	Remove the jumper from these pins to measure the TRC105 current

Table 3 - DR-TRC105 Radio Board Test Points

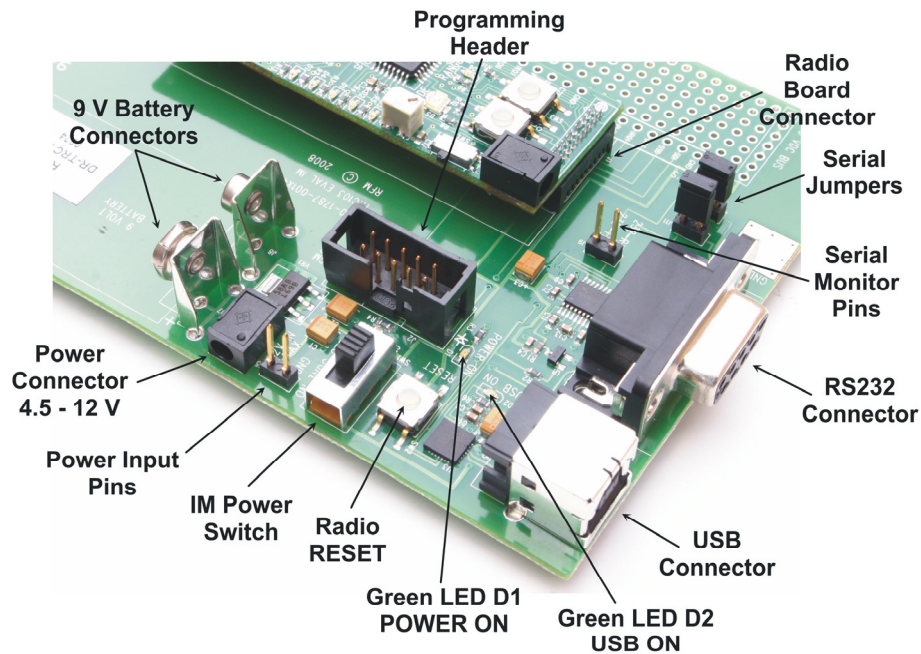

Figure 14 - DR-TRC103/105 Interface Board Details

Interface Board Details

Figure 14 and Table 4 summarizes the functions of the DR-TRC103/105 interface board connectors, user controls and LED indicators. Also note that many of the radio board test points are duplicated on the edge of the interface board prototyping area.

Component	Designator	Function
Radio Connector	J1	20-pin radio board interface connector
Micro Connector	J2	10-pin microprocessor programming connector, SiLabs compatible
RS232 Connector	J3	RS232 9-pin D connector
Power Connector	J4	Coaxial power connector, 4.5 to 12 volts
Power Input Pins	J5	Alternate power input pins, 4.5 to 12 volts
USB Connector	J6	Type B USB Connector
Battery Connectors	J7-J8	9 volt battery connectors
Serial Monitor Pins	J9	Monitoring pins for logic-level serial data
TX Serial Jumper	J10	Routes logic-level serial data to USB converter, remove for RS232 operation
RX Serial Jumper	J11	Routes logic-level serial data from USB converter, remove for RS232 operation
POWER Switch	SW1	Regulated 3 volt power switch
Radio RESET Switch	SW2	Radio firmware reset switch
POWER LED	D1	Green LED illuminates when POWER switch is on
USB ON LED	D2	Green LED illuminates when USB is active

Table 4 - DR-TRC103/105 Interface Board Connector, Control and Indicator Functions

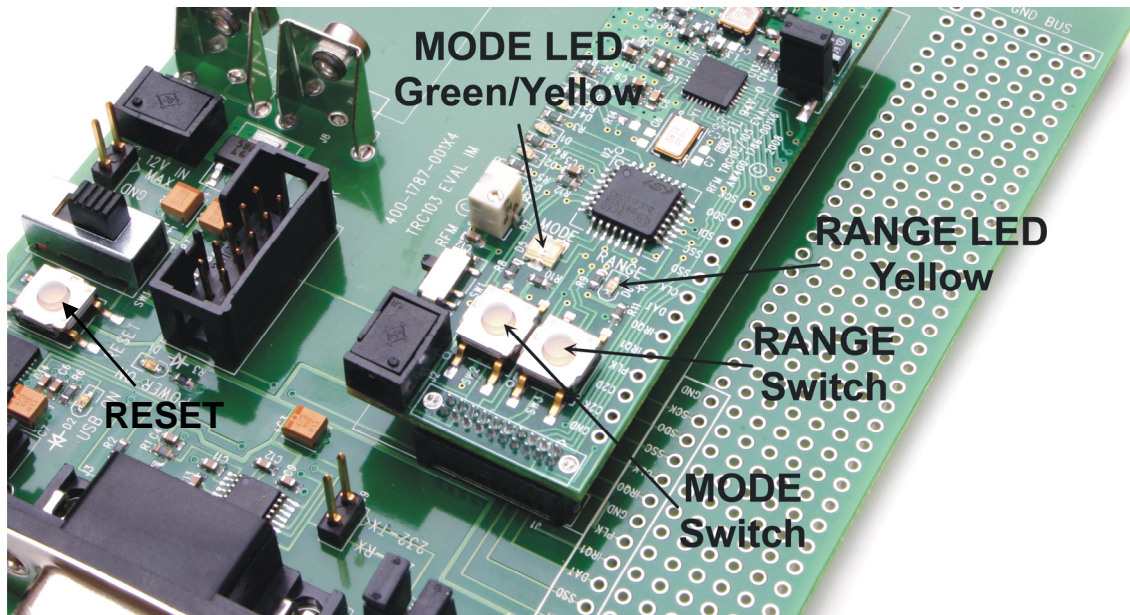

Figure 15 - Mode Switches and LEDs

Radio Board Firmware Details

Table 5 summarizes the switch-selectable modes supported by the radio board firmware. Figure 15 shows the location of the mode selection switches and LEDs.

Mode	Mode Selection
Reset	Cycle power or press the RESET switch on the interface board. All LEDs on the radio board will flash, and the MODE LED will illuminate green. The default operating frequency and firmware version message is output on the serial connection.
Receive Continuous	Default mode following a reset. MODE LED is green.
Transmit Continuous	Following a reset, press the MODE button briefly. MODE LED is yellow.
Sleep Cycle	Following a reset, press the MODE button twice briefly. MODE LED is off. Serial/PLL LED will periodically flash.
Range Test Receive (Packet Receive)	Following a reset, press the RANGE button briefly. The RANGE LED will illuminate yellow. The message RX MODE is output on the serial connection.
Range Test Transmit	Following a reset, press and hold the RANGE button until several LEDs begin flashing.
Terminal	Following a reset, press the RANGE button briefly twice, with about one second between the first and second button press. On the first press, the message RX MODE is output on the serial connection. On the second button press, the message TERM MODE is output on the serial connection.

Table 5 - DR-TRC105 Firmware Switch-selectable Modes

The firmware includes several command formats that are used by the RFIC Design Assistant utility program to read and write parameters to the TRC105 configuration registers and to send and receive terminal mode messages. Table 6 summarizes several commands that are useful for proof-of-concept testing.

Command	Format	Example
Write Register	Wrrdd or wrrdd	Write register rr with data dd, where rr and dd are two character hex values. For example, write 0x80 to register 0x01 is formatted as <i>W0108</i> .
Terminal Mode Send	02msg03	The DR-TRC105 radio board must be in terminal mode, as discussed in Table 5 above. The user's message, up to 63 bytes, must be preceded with an ASCII 0x02 start-of-text character, and followed by an ASCII 0x03 end-of-text character. For example, the string of hex characters to send Hello in ASCII is: <i>0248656C6C6F03</i>
Terminal Mode Receive	02msg030D0A	When the example string above is output by the receiving node, an ASCII carriage return - line feed is added as follows: <i>0248656C6C6F030D0A</i>

Table 6 - DR-TRC105 Firmware Serial Commands

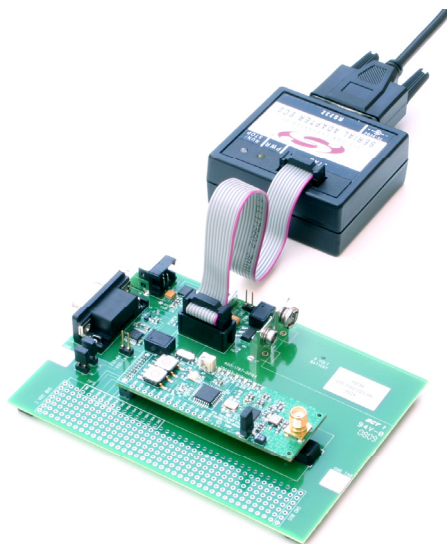

Figure 16 - DR-TRC103/105 Interface Board Connector for Firmware Development Support

Custom Firmware Development Support

The 10-pin programming header on the interface board is compatible with the Silicon Labs development tools for the C8051F310 microcontroller. This allows the user to develop and test custom firmware for use with the TRC105.

Firmware should be loaded and tested with the interface board powered on. The C source code for the firmware shipped in the development kit is included on the CD for reference.

Radio Board Interface Connector

Figure 17 shows the pin numbering detail of connector J2 on the edge of the DR-TRC105 radio boards. Figure 17 can be used with the schematics in the last section of this manual to design a custom application interface for the radio boards. Note that all signal levels into and out of this connector are nominally 3 volt logic level. Attempting to use RS232 signal levels to directly interface the radio board can damage it.

J2 pin numbering as viewed from the top of a DR-TRC105 radio board (connector points down)

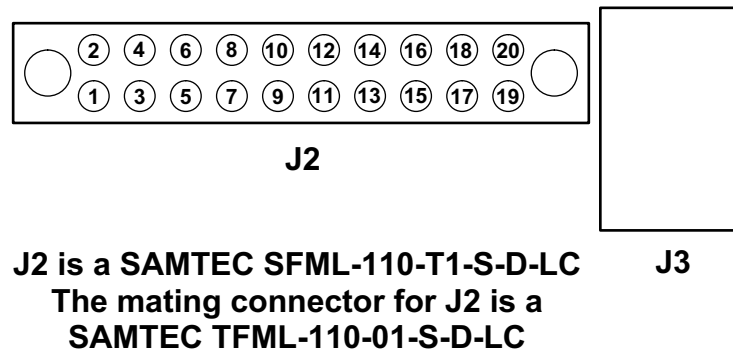
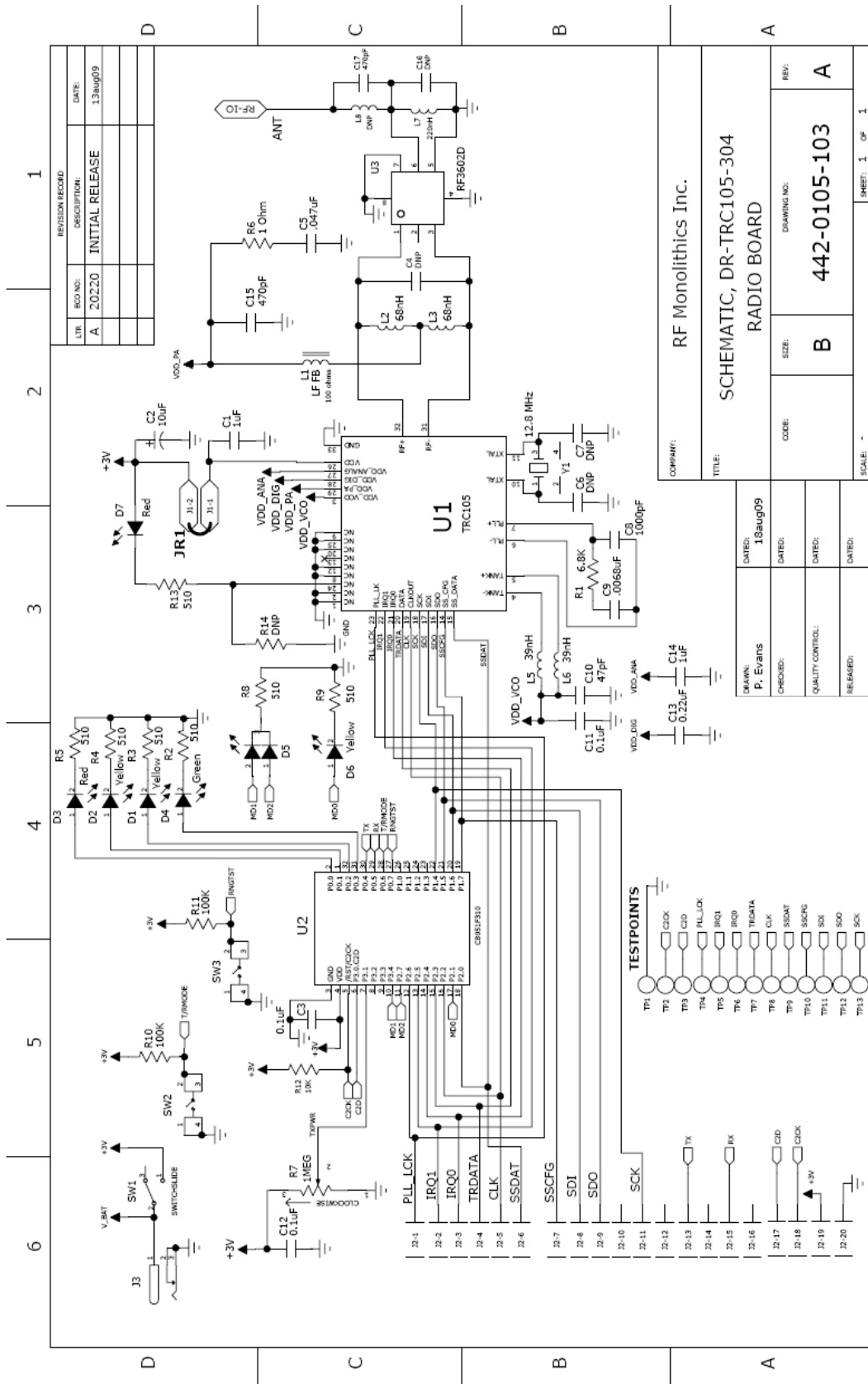
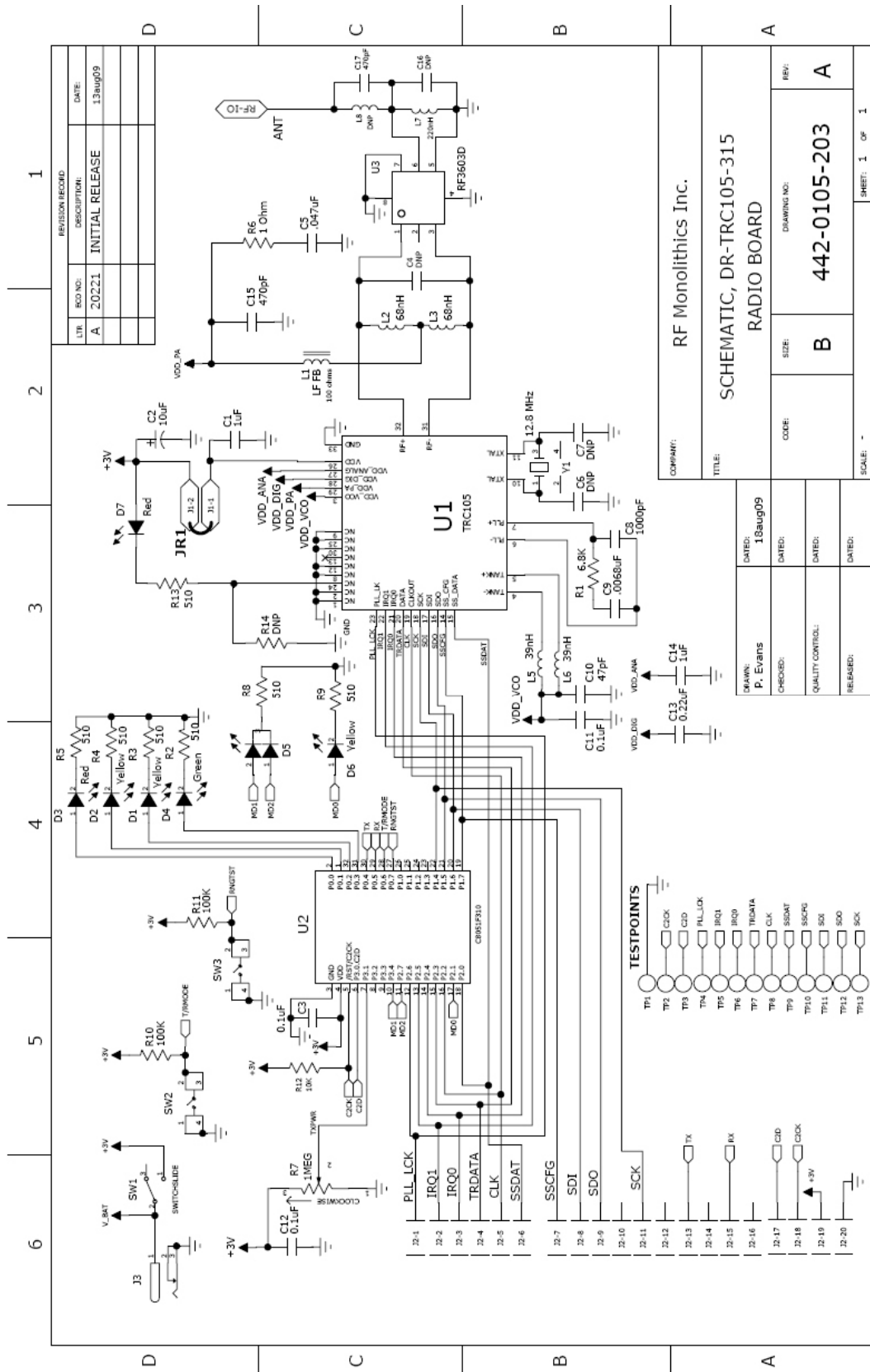

Figure 17 - DR-TRC105 Radio Board Connector Detail

Development Kit Documentation

The schematics of each radio board and the interface board with the top assembly views are provided on the following pages. Also see the RFIC Design Assistant utility software and related User's Guide, the DR-TRC105-EV Evaluation Kit User's Guide, and the TRC105 Data Sheet. The latest versions of the Data Sheet, User's Guides, and the RFIC Design Assistant utility software can be downloaded from RFM's web site, www.rfm.com.





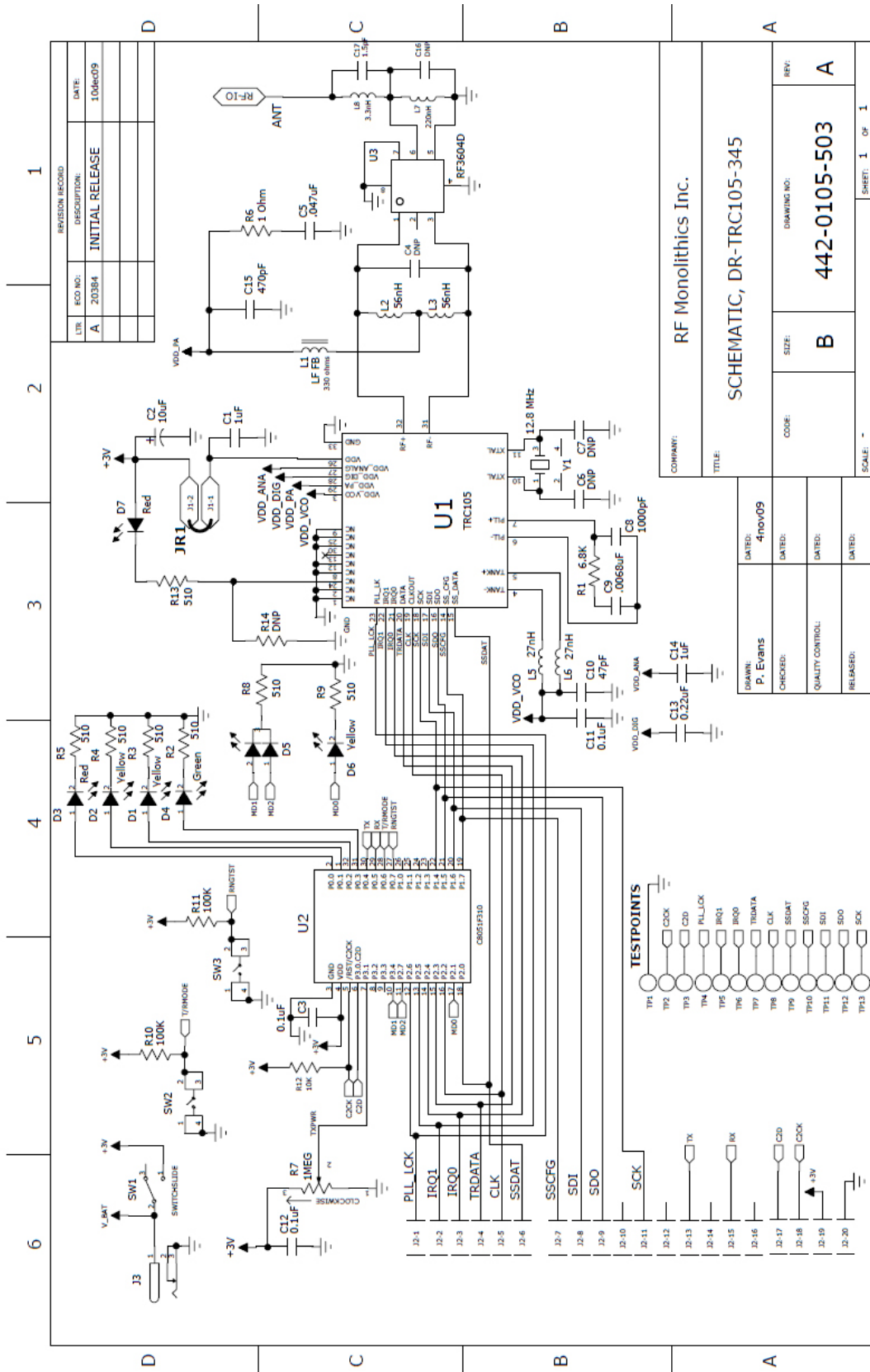

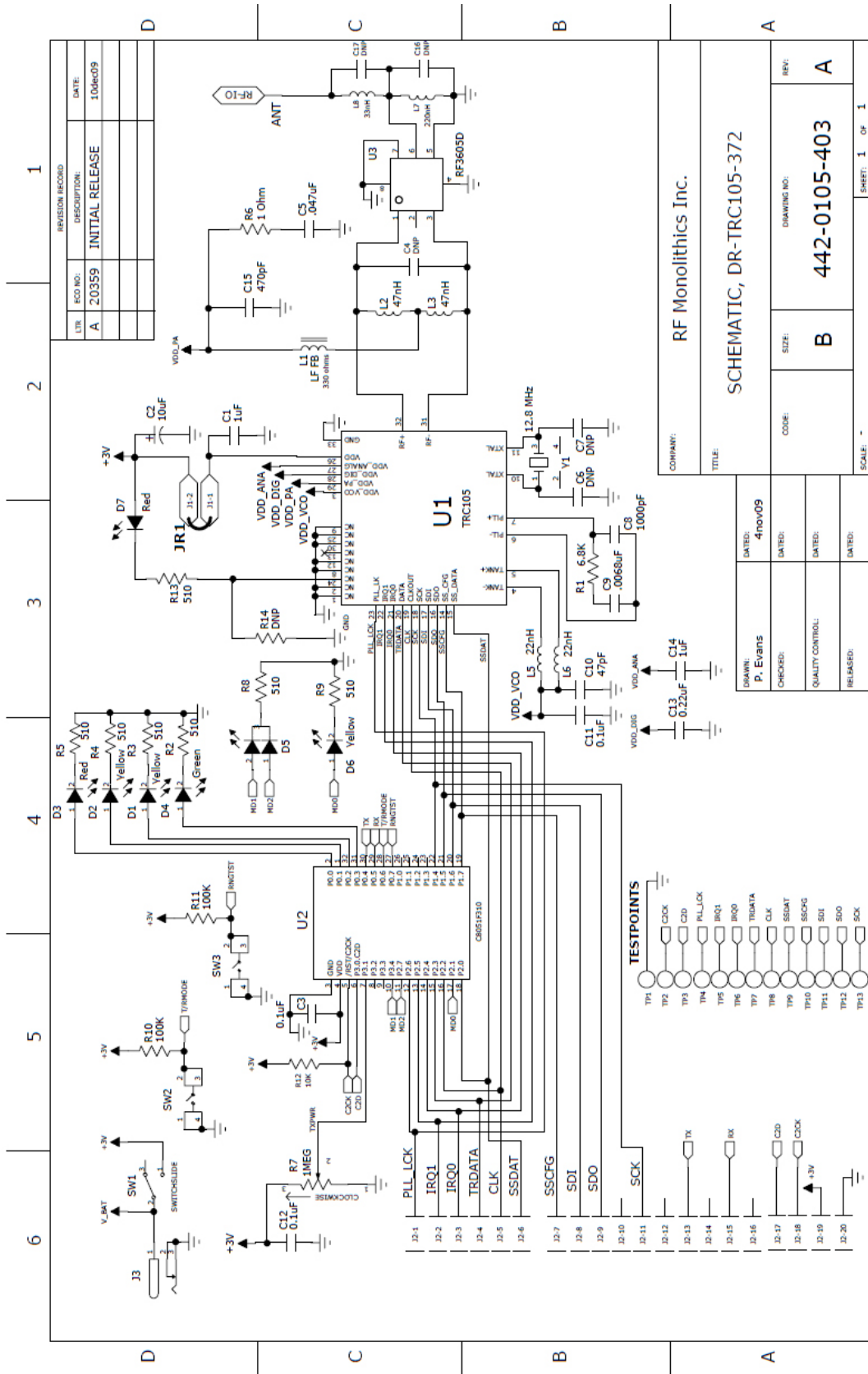

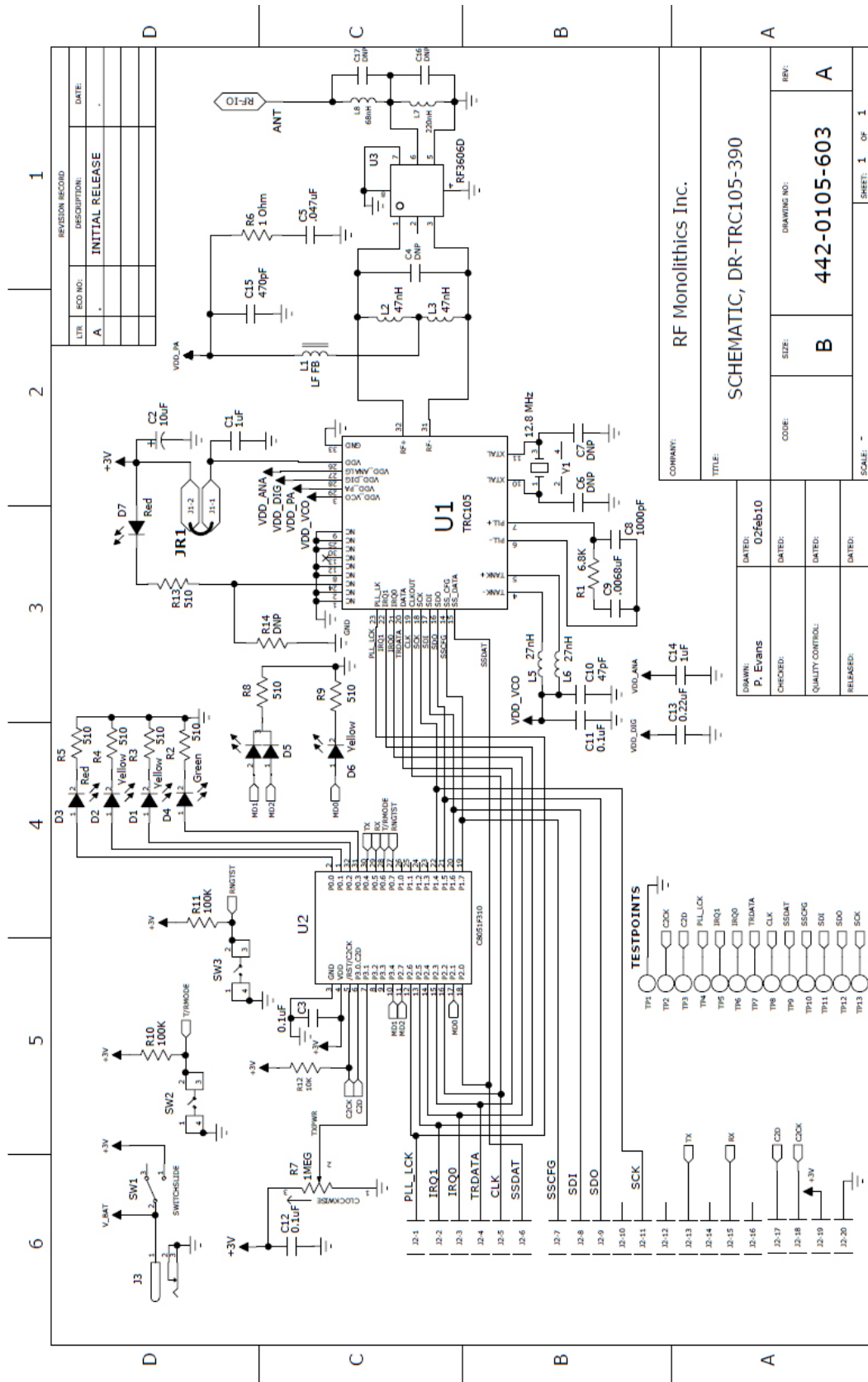

REVISION RECORD		
LTR.	ECO NO.	DESCRIPTION
A		INITIAL RELEASE

COMPANY:		RF Monolithics Inc.	
TITLE:		SCHEMATIC, DR-TRC105-390	
DATE:	02Feb10	SIZE:	B
CHECKED:	P. Evans	CODE:	
QUALITY CONTROL:		DRAWING NO.:	442-0105-603
RELEASED:		SCALE:	1 OF 1

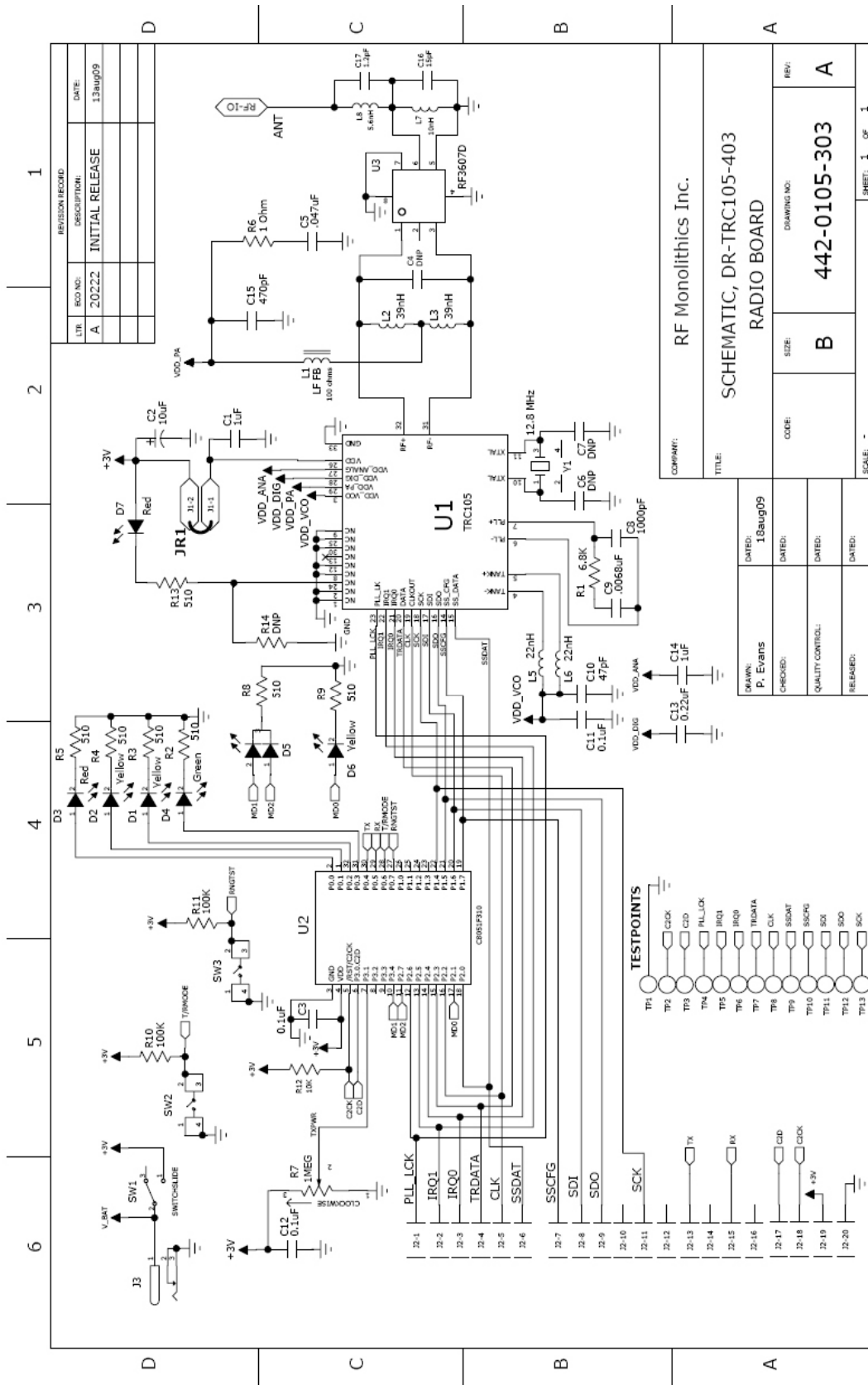

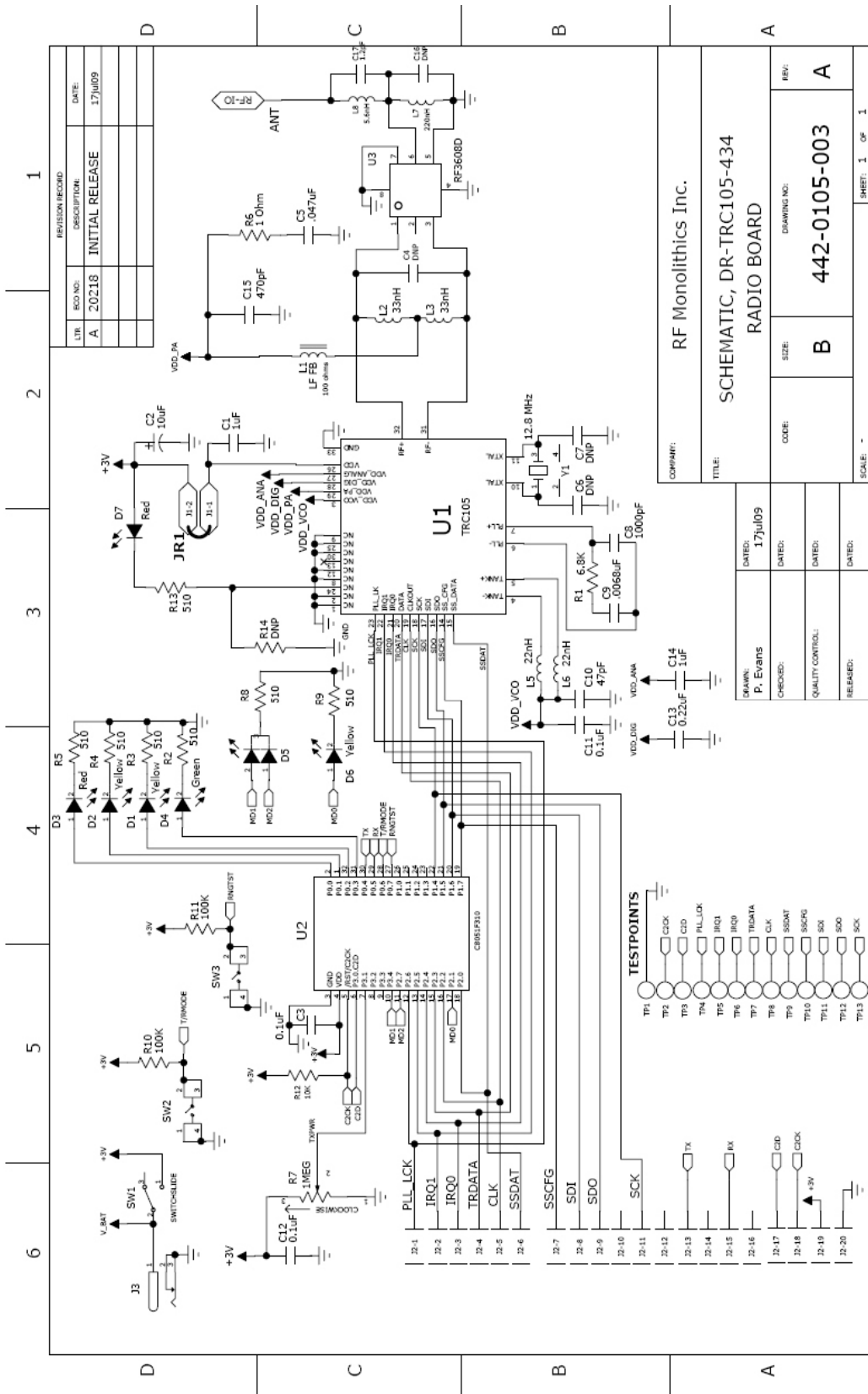

REVISION RECORD		DATE:
LTR	ECO NO.	DESCRIPTION:
A	20218	INITIAL RELEASE
		17/10/09

COMPANY:		RF Monolithics Inc.	
TITLE:			
SCHEMATIC, DR-TRC105-434 RADIO BOARD			
DATE:	17/10/09	DATE:	
CHECKED:	P. Evans	DATE:	
QUALITY CONTROL:		DATE:	
RELEASED:		DATE:	
SCALE:		SHEET:	1 OF 1

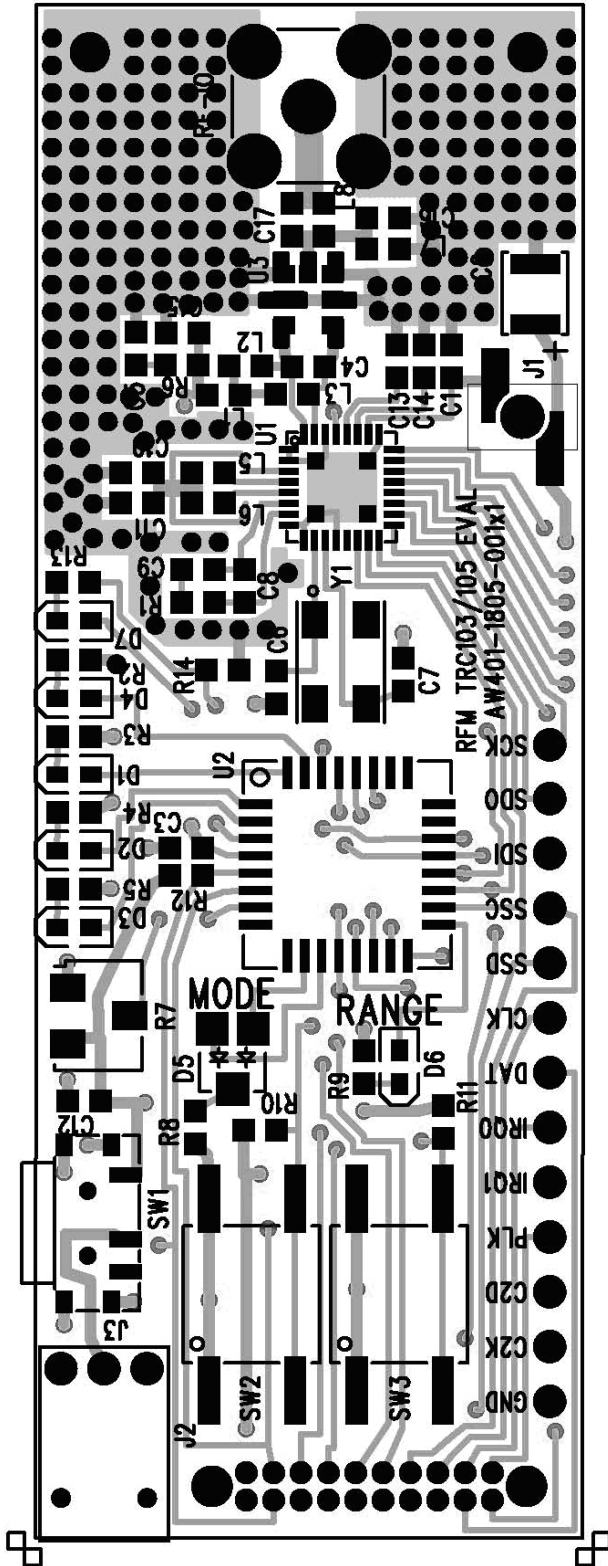

Circuit board dimensions: 1.00 x 2.80 x 0.65 inches (25.4 x 71.1 x 16.5 mm)

Bands on inductors as shown:



