

MAX44260/MAX44261

1.8V 15MHz Low-Offset, Low-Power, Rail-to-Rail I/O Op Amps

General Description

The MAX44260/MAX44261 offer a unique combination of high speed, precision, low noise, and low-voltage operation making them ideally suited for a large number of signal processing functions such as filtering and amplification of signals in portable and industrial equipment.

The amplifiers feature an input offset of less than 50 μ V and a high-gain bandwidth product of 15MHz while maintaining a low 1.8V supply rail. The devices' rail-to-rail input/outputs and low noise guarantee maximum dynamic range in demanding applications such as 12- to 14-bit SAR ADC drivers. Unlike traditional rail-to-rail input structures, input crossover distortion is absent due to an optimized input stage with an ultra-quiet charge pump.

The MAX44260 includes a fast-power-on shutdown mode for further power savings. The MAX44261 offers a unique on-demand calibration pin where the user can invoke self-trimming of the input offset voltage.

The family of parts operates from a supply range of 1.8V to 5.5V over the -40°C to +125°C temperature range and can operate down to 1.7V over the 0°C to +70°C temperature range. The MAX44260/MAX44261 are available in small, 6-pin SC70 packages. The MAX44260 is also available in a 1mm x 1.5mm thin μ DFN (ultra-thin LGA) package.

Ordering Information appears at end of data sheet.

Features

- ◆ Low 1.8V Supply Rail Over the -40°C to +125°C Range
- ◆ 1.7V Supply Rail Over the 0°C to +70°C Range
- ◆ 15MHz Unity-Gain Bandwidth
- ◆ Low 12.7nV/ $\sqrt{\text{Hz}}$ Input Voltage-Noise Density
- ◆ Low 1.2fA/ $\sqrt{\text{Hz}}$ Input Current-Noise Density
- ◆ Low 50 μ V (max) V_{OS} at +25°C
- ◆ On-Demand V_{OS} Self-Calibration (MAX44261)
- ◆ 500fA Low Input Bias Current
- ◆ 750 μ A Quiescent Current per Amplifier
- ◆ < 1 μ A Supply Current in Shutdown
- ◆ Small, 2mm x 2mm SC70 and 1mm x 1.5mm Thin μ DFN (MAX44260) Packages
- ◆ Low 110dB Total Harmonic Distortion

Applications

Notebooks
3G/4G Handsets
Portable Media Players
Portable Medical Instruments
Battery-Operated Devices
Analog-to-Digital Converter Buffers
Transimpedance Amplifiers
General-Purpose Signal Processing

Typical Application Circuit

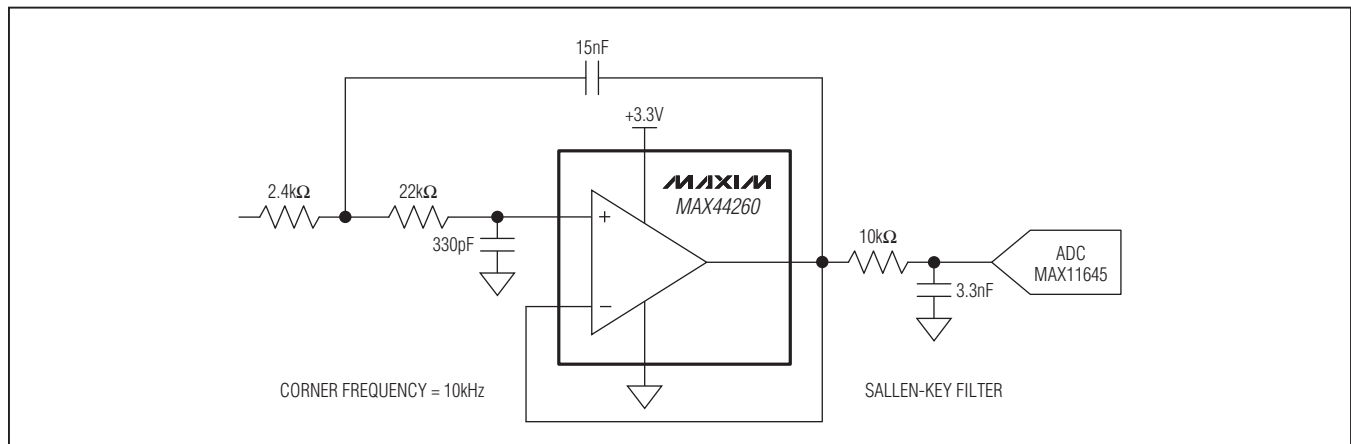

For related parts and recommended products to use with this part, refer to: www.maxim-ic.com/MAX44260.related

MAX44260/MAX44261

1.8V 15MHz Low-Offset, Low-Power, Rail-to-Rail I/O Op Amps

ABSOLUTE MAXIMUM RATINGS

IN+, IN-, OUT	(V _{SS} - 0.3V) to (V _{DD} + 0.3V)	6-Pin Thin μ DFN (Ultra-Thin LGA)	
V _{DD} to V _{SS}	-0.3V to +6V	(derate 2.1mW/°C above +70°C)	110.2mW
SHDN, CAL	-0.3V to +6V	Operating Temperature Range	-40°C to +125°C
Output to Short-Circuit Ground Duration	10s	Junction Temperature	+150°C
Continuous Input Current into Any Pin.....	\pm 20mA	Lead Temperature (soldering, 10s)	+300°C
Continuous Power Dissipation (T _A = +70°C)		Soldering Temperature (reflow)	+260°C
SC70 (derate 3.1mW/°C above +70°C)	245mW		

Stresses beyond those listed under "Absolute Maximum Ratings" may cause permanent damage to the device. These are stress ratings only, and functional operation of the device at these or any other conditions beyond those indicated in the operational sections of the specifications is not implied. Exposure to absolute maximum rating conditions for extended periods may affect device reliability.

PACKAGE THERMAL CHARACTERISTICS (Note 1)

SC70	Thin μ DFN (Ultra-Thin LGA)
Junction-to-Ambient Thermal Resistance (θ_{JA})	326.5°C/W
Junction-to-Case Thermal Resistance (θ_{JC})	115°C/W
	Junction-to-Ambient Thermal Resistance (θ_{JA})
	470°C/W

Note 1: Package thermal resistances were obtained using the method described in JEDEC specification JESD51-7, using a four-layer board. For detailed information on package thermal considerations, refer to www.maxim-ic.com/thermal-tutorial.

ELECTRICAL CHARACTERISTICS

(V_{DD} = 3.3V, V_{SS} = 0V, V_{IN+} = V_{IN-} = V_{DD}/2, R_L = 10k Ω to V_{DD}/2, V_{CAL} = V_{SHDN} = V_{DD}, T_A = -40°C to +125°C. Typical values are at T_A = +25°C, unless otherwise noted.) (Note 2)

PARAMETER	SYMBOL	CONDITIONS	MIN	TYP	MAX	UNITS
DC CHARACTERISTICS						
Input Voltage Range	V _{IN+} V _{IN-}	Guaranteed by CMRR test	-0.1		V _{DD} + 0.1	V
Input Offset Voltage	V _{OS}	T _A = +25°C		10	50	μ V
		T _A = -40°C to +125°C after calibration			100	
		T _A = -40°C to +125°C			500	
Input Offset Voltage Drift	V _{OS} - TC			0.8	5	μ V/°C
Input Bias Current	I _B	T _A = +25°C		0.01	0.5	pA
		T _A = -40°C to +85°C			10	
		T _A = -40°C to +125°C			100	
Input Capacitance	C _{IN}			0.4		pF
Common-Mode Rejection Ratio	CMRR	V _{CM} = -0.1V to (V _{DD} + 0.1V)	75	90		dB
Open-Loop Gain	A _{OL}	0.4V \leq V _{OUT} \leq V _{DD} - 0.4V, R _{OUT} = 10k Ω	100	115		dB
		0.4V \leq V _{OUT} \leq V _{DD} - 0.4V, R _{OUT} = 600 Ω	91	100		
		0.4V \leq V _{OUT} \leq V _{DD} - 0.4V, R _{OUT} = 32 Ω		80		
Output Short-Circuit Current	I _{SC}	To V _{DD} or V _{SS}		50		mA

MAX44260/MAX44261

1.8V 15MHz Low-Offset, Low-Power, Rail-to-Rail I/O Op Amps

ELECTRICAL CHARACTERISTICS (continued)

($V_{DD} = 3.3V$, $V_{SS} = 0V$, $V_{IN+} = V_{IN-} = V_{DD}/2$, $R_L = 10k\Omega$ to $V_{DD}/2$, $V_{CAL} = V_{SHDN} = V_{DD}$, $T_A = -40^\circ C$ to $+125^\circ C$. Typical values are at $T_A = +25^\circ C$, unless otherwise noted.) (Note 2)

PARAMETER	SYMBOL	CONDITIONS	MIN	TYP	MAX	UNITS
Output Voltage Swing	$V_{OL} - V_{SS}$	$R_{OUT} = 10k\Omega$			20	mV
		$R_{OUT} = 600\Omega$			50	
		$R_{OUT} = 32\Omega$	400		700	
	$V_{DD} - V_{OH}$	$R_{OUT} = 10k\Omega$			10	
		$R_{OUT} = 600\Omega$			40	
		$R_{OUT} = 32\Omega$	400		800	
AC CHARACTERISTICS						
Input Voltage-Noise Density	e_n	$f = 10kHz$		12.7		nV/\sqrt{Hz}
Input Current-Noise Density	i_n	$f = 10kHz$		1.2		fA/\sqrt{Hz}
Gain-Bandwidth Product	GBWP			15		MHz
Slew Rate	SR			7		$V/\mu s$
Settling Time		$V_{OUT} = 2V_{P-P}$, $V_{DD} = 3.3V$, $A_V = 1V/V$, $C_L = 30pF$ (load), settle to 0.01%		1.7		μs
Capacitive Loading	C_{LOAD}	No sustained oscillation		300		pF
Total Harmonic Distortion	THD	$f = 10kHz$, $V_O = 2V_{P-P}$, $A_V = 1$, $R_{OUT} = 10k\Omega$		-110		dB
Output Transient Recovery Time		$\Delta V_{OUT} = 0.2V$, $V_{DD} = 3.3V$, $A_V = 1V/V$; $R_S = 20\Omega$, $C_L = 1nF$ (load)		1		μs
POWER-SUPPLY CHARACTERISTICS						
Power-Supply Range	V_{DD}	Guaranteed by PSRR	1.8		5.5	V
		$T_A = 0^\circ C$ to $+70^\circ C$	1.7		5.5	
Power-Supply Rejection Ratio	PSRR	$V_{CM} = V_{DD}/2$	82	95		dB
Quiescent Current	I_{DD}			750	1200	μA
Shutdown Supply Current	I_{SHDN}	MAX44260/MAX44261 only			1	μA
Shutdown Input Low	V_{IL}				0.7	V
Shutdown Input High	V_{IH}		1.3			V
Output Leakage Current in Shutdown	I_{SHDN}			100		pA
Shutdown Input Bias Current	I_{IL}/I_{IH}	MAX44260			1	μA
		MAX44261			0.1	
Shutdown Turn-On Time	t_{SHDN}	$T_A = +25^\circ C$ (Note 3)		14.4	18.9	μs
		$T_A = -40^\circ C$ to $+125^\circ C$ (Note 3)			26.7	
Turn-On Time	t_{ON}	$T_A = +25^\circ C$ (Note 3)		9.7	15.2	ms
		$T_A = -40^\circ C$ to $+125^\circ C$ (Note 3)			18.4	

Note 2: All devices are 100% production tested at $T_A = +25^\circ C$. Temperature limits are guaranteed by design.

Note 3: Guaranteed by design.

MAX44260/MAX44261

1.8V 15MHz Low-Offset, Low-Power, Rail-to-Rail I/O Op Amps

Typical Operating Characteristics

($V_{DD} = 3.3V$, $V_{SS} = 0V$, $V_{IN+} = V_{IN-} = V_{DD}/2$, $R_L = 10k\Omega$ to $V_{DD}/2$, $V_{CAL} = V_{SHDN} = V_{DD}$, $T_A = -40^\circ C$ to $+125^\circ C$. Typical values are at $T_A = +25^\circ C$, unless otherwise noted. All devices are 100% production tested at $T_A = +25^\circ C$. Temperature limits are guaranteed by design.)

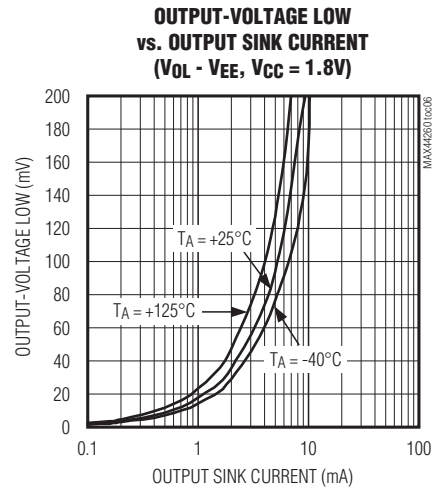
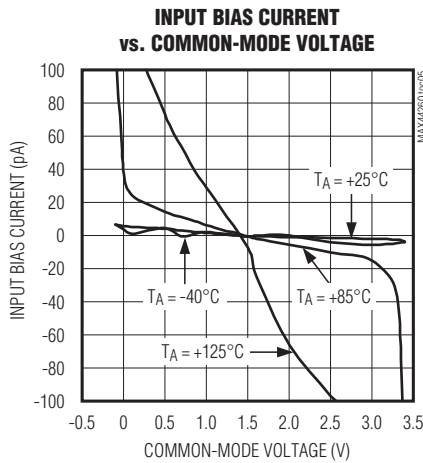
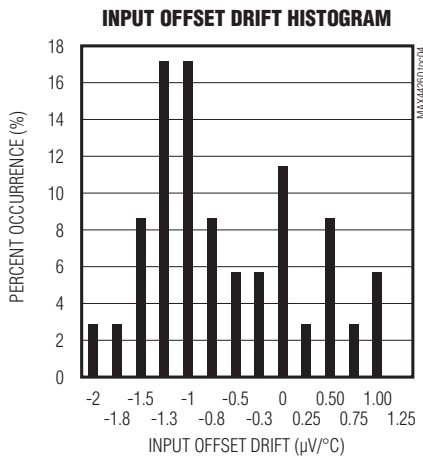
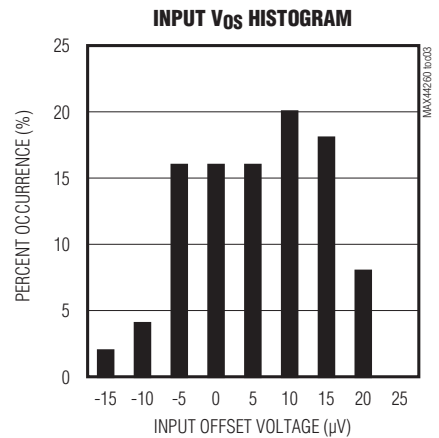
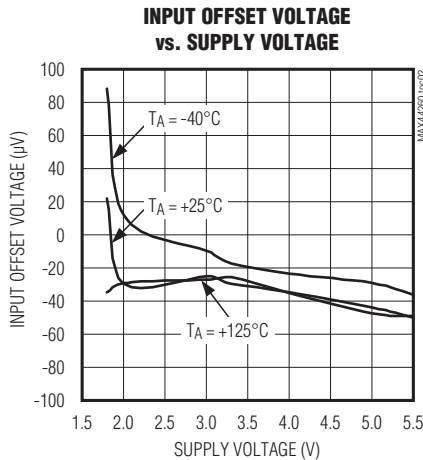
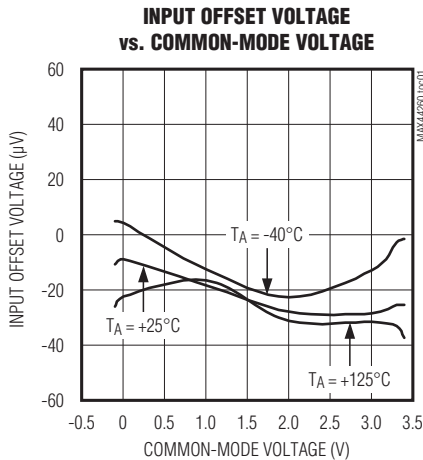

MAX44260/MAX44261

1.8V 15MHz Low-Offset, Low-Power, Rail-to-Rail I/O Op Amps

Typical Operating Characteristics (continued)

($V_{DD} = 3.3V$, $V_{SS} = 0V$, $V_{IN+} = V_{IN-} = V_{DD}/2$, $R_L = 10k\Omega$ to $V_{DD}/2$, $V_{CAL} = V_{SHDN} = V_{DD}$, $T_A = -40^\circ C$ to $+125^\circ C$. Typical values are at $T_A = +25^\circ C$, unless otherwise noted. All devices are 100% production tested at $T_A = +25^\circ C$. Temperature limits are guaranteed by design.)

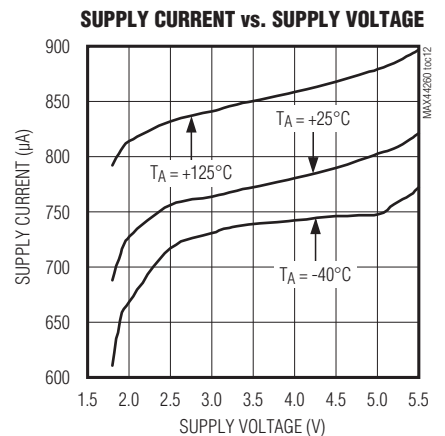
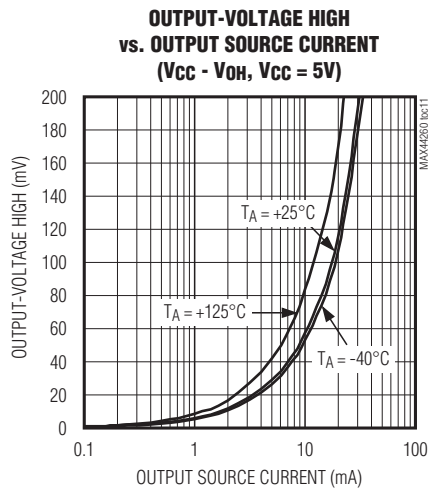
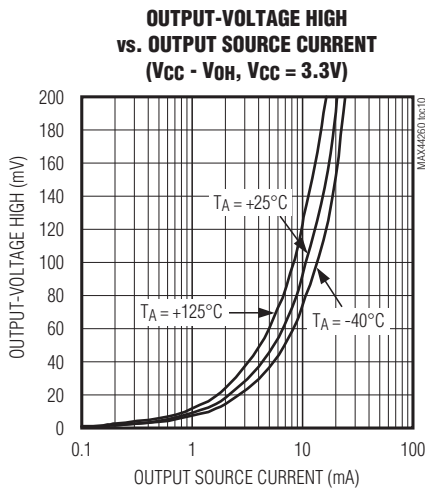
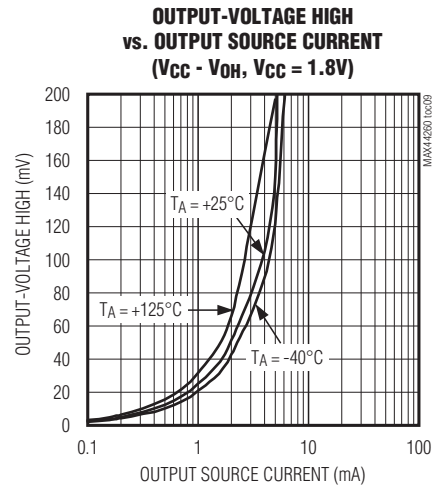
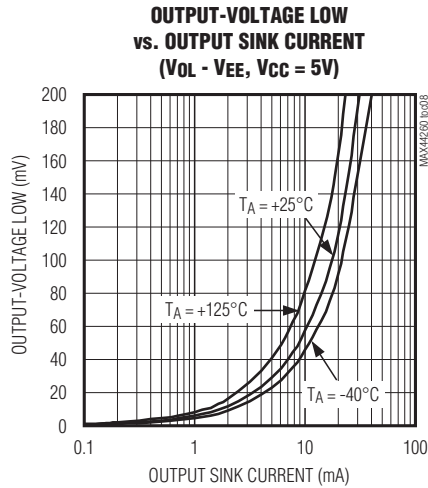
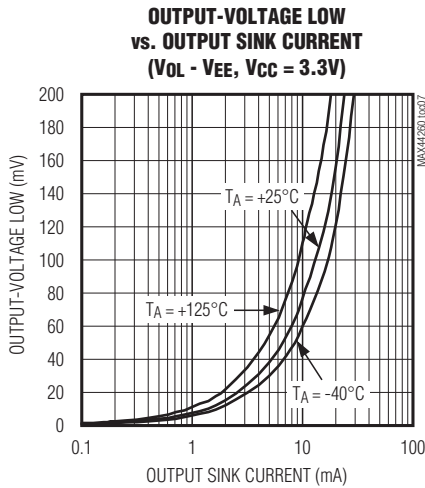

MAX44260/MAX44261

1.8V 15MHz Low-Offset, Low-Power, Rail-to-Rail I/O Op Amps

Typical Operating Characteristics (continued)

($V_{DD} = 3.3V$, $V_{SS} = 0V$, $V_{IN+} = V_{IN-} = V_{DD}/2$, $R_L = 10k\Omega$ to $V_{DD}/2$, $V_{CAL} = V_{SHDN} = V_{DD}$, $T_A = -40^\circ C$ to $+125^\circ C$. Typical values are at $T_A = +25^\circ C$, unless otherwise noted. All devices are 100% production tested at $T_A = +25^\circ C$. Temperature limits are guaranteed by design.)

SHUTDOWN SUPPLY CURRENT vs. SUPPLY VOLTAGE
($V_{SHDN} = V_{EE}$)

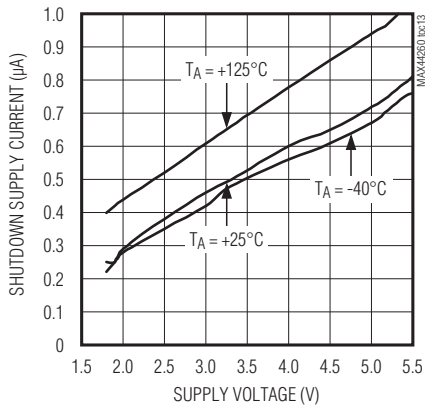

OPEN-LOOP GAIN vs. FREQUENCY

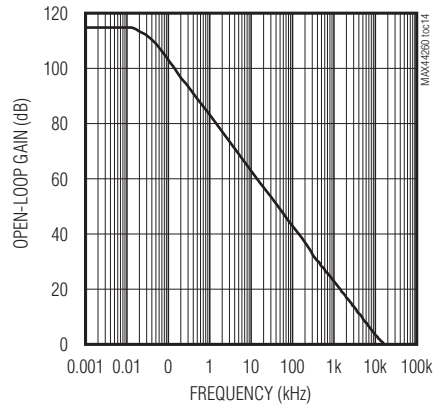

COMMON-MODE REJECTION RATIO vs. FREQUENCY

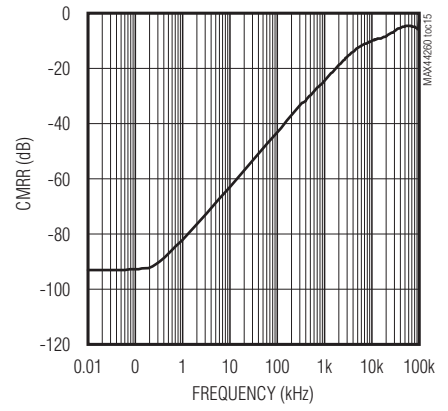

POWER-SUPPLY REJECTION RATIO vs. FREQUENCY

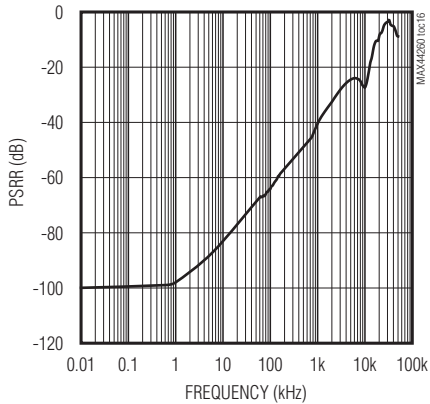

DC CMRR AND PSRR vs. TEMPERATURE

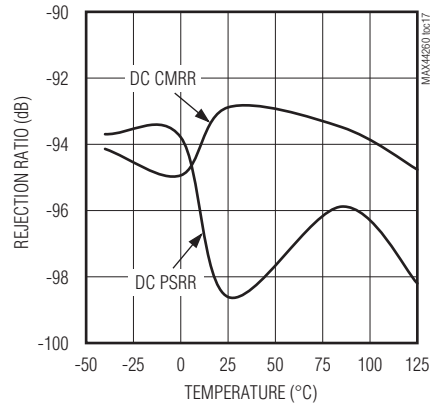

INPUT VOLTAGE-NOISE DENSITY vs. FREQUENCY

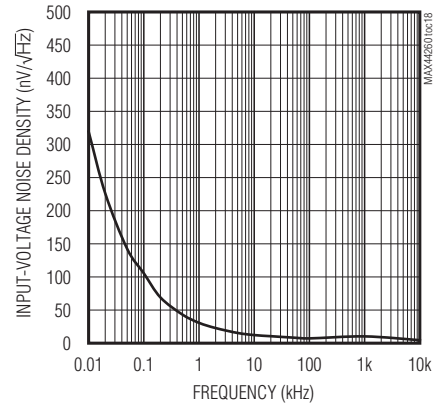

MAX44260/MAX44261

1.8V 15MHz Low-Offset, Low-Power, Rail-to-Rail I/O Op Amps

Typical Operating Characteristics (continued)

($V_{DD} = 3.3V$, $V_{SS} = 0V$, $V_{IN+} = V_{IN-} = V_{DD}/2$, $R_L = 10k\Omega$ to $V_{DD}/2$, $V_{CAL} = V_{SHDN} = V_{DD}$, $T_A = -40^\circ C$ to $+125^\circ C$. Typical values are at $T_A = +25^\circ C$, unless otherwise noted. All devices are 100% production tested at $T_A = +25^\circ C$. Temperature limits are guaranteed by design.)

0.1Hz TO 10Hz OUTPUT-VOLTAGE NOISE

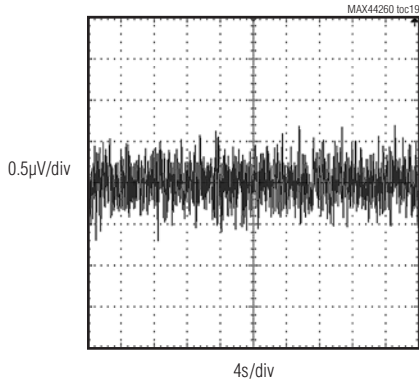

INPUT CURRENT-NOISE DENSITY vs. FREQUENCY

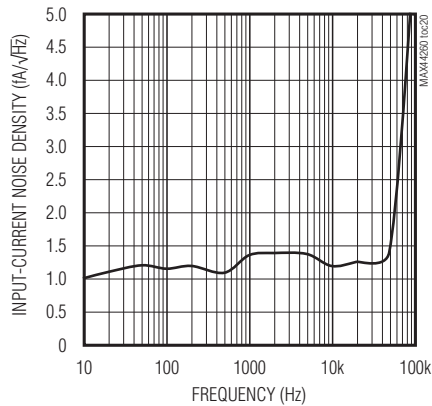

TOTAL HARMONIC DISTORTION vs. INPUT AMPLITUDE (f = 10kHz, $V_{CC} = 5.5V$, $A_V = 1V/V$)

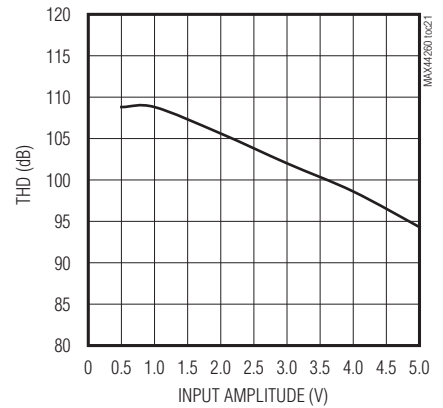

TOTAL HARMONIC DISTORTION vs. FREQUENCY ($V_{IN} = 2VP-P$)

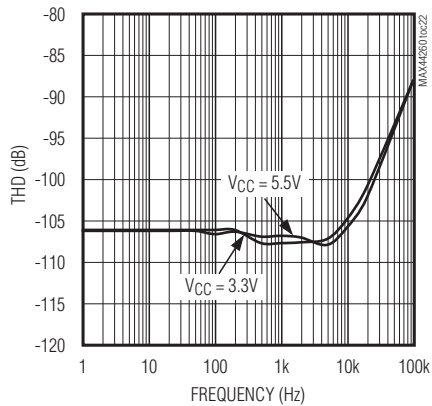

SMALL-SIGNAL TRANSIENT RESPONSE

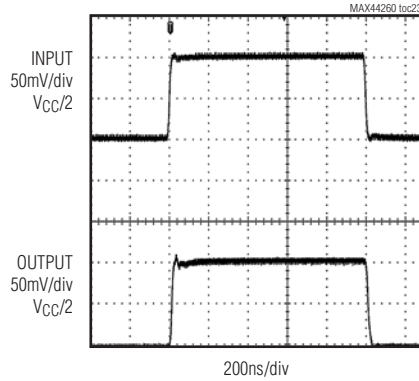

LARGE-SIGNAL TRANSIENT RESPONSE

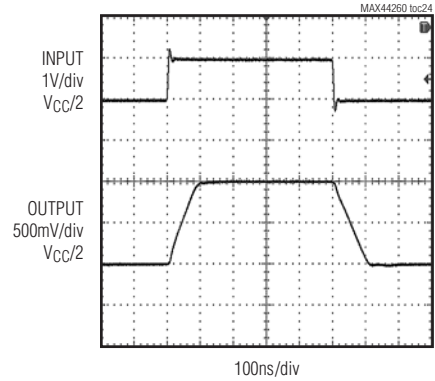

MAX44260/MAX44261

1.8V 15MHz Low-Offset, Low-Power, Rail-to-Rail I/O Op Amps

Typical Operating Characteristics (continued)

($V_{DD} = 3.3V$, $V_{SS} = 0V$, $V_{IN+} = V_{IN-} = V_{DD}/2$, $R_L = 10k\Omega$ to $V_{DD}/2$, $V_{CAL} = V_{SHDN} = V_{DD}$, $T_A = -40^\circ C$ to $+125^\circ C$. Typical values are at $T_A = +25^\circ C$, unless otherwise noted. All devices are 100% production tested at $T_A = +25^\circ C$. Temperature limits are guaranteed by design.)

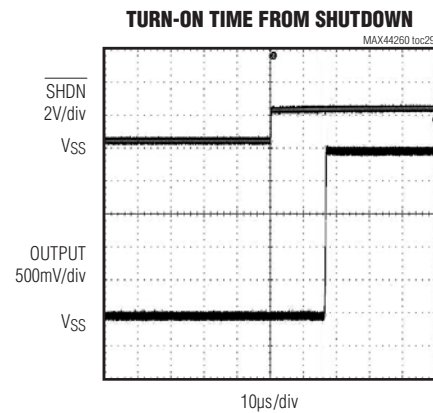
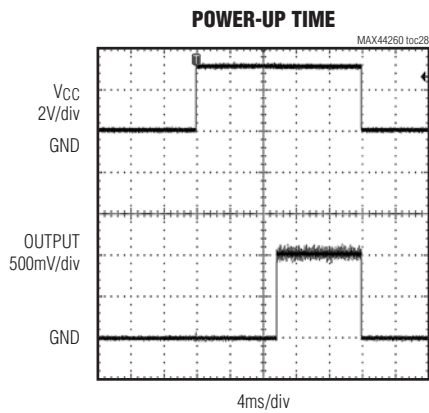
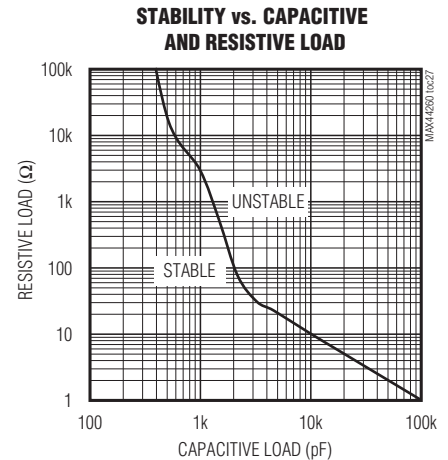
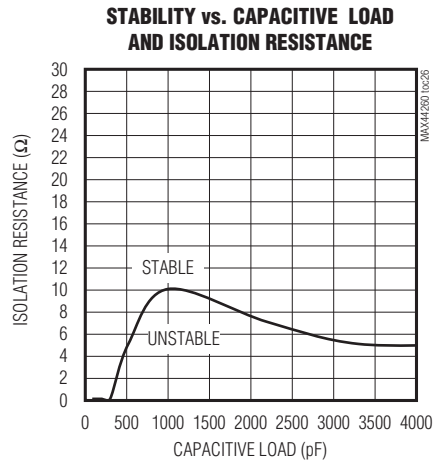
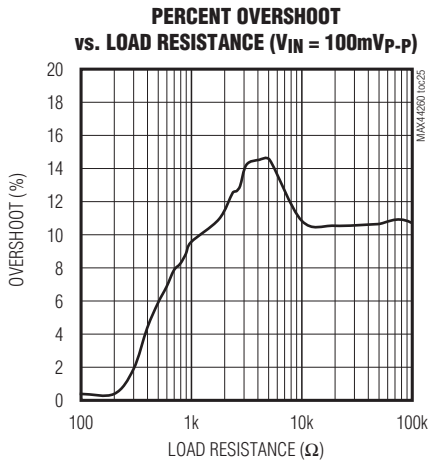

MAX44260/MAX44261

1.8V 15MHz Low-Offset, Low-Power, Rail-to-Rail I/O Op Amps

Pin Configurations

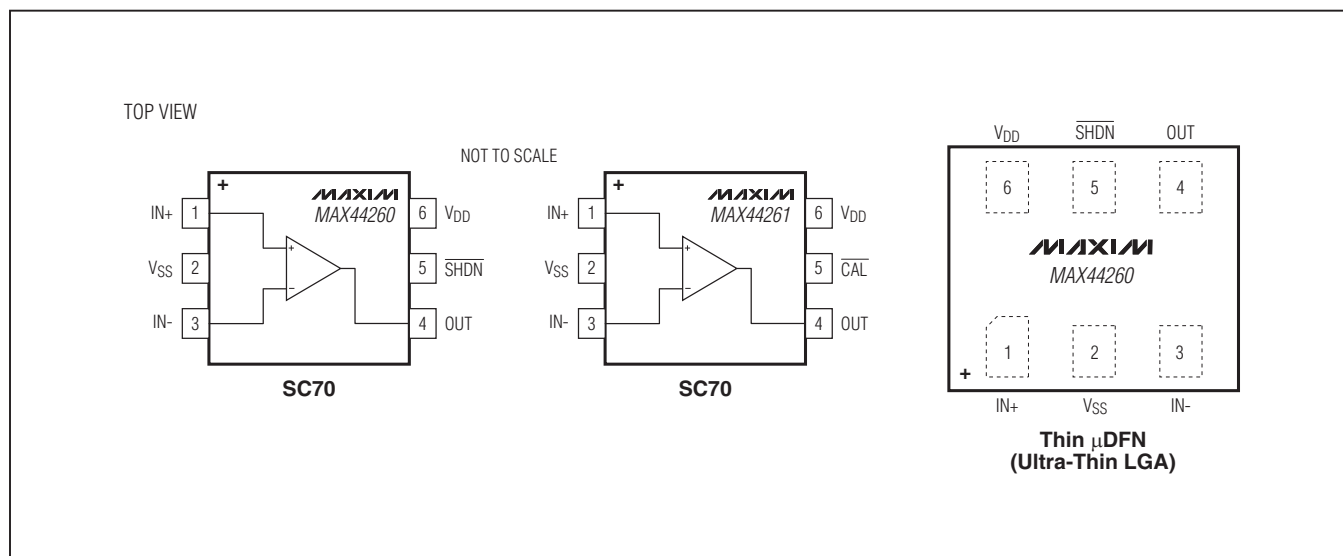

Pin Description

PIN		NAME	FUNCTION
MAX44260	MAX44261		
1	1	IN+	Positive Input
2	2	V _{SS}	Negative Power Supply. Bypass with a 0.1μF capacitor to ground.
3	3	IN-	Negative Input
4	4	OUT	Output
—	5	CAL	Active-Low Calibrate Input
5	—	SHDN	Active-Low Shutdown
6	6	V _{DD}	Positive Power Supply. Bypass with a 0.1μF capacitor to ground.

MAX44260/MAX44261

1.8V 15MHz Low-Offset, Low-Power, Rail-to-Rail I/O Op Amps

Detailed Description

The MAX44260/MAX44261 are high-speed low-power op amps ideal for signal processing applications due to the device's high precision and low-noise CMOS inputs. The devices self-calibrate on power-up to eliminate effects of temperature and power-supply variation.

The MAX44260 also features a low-power shutdown mode that greatly reduces quiescent current while the device is not operational and recovers in 30 μ s.

The MAX44261 features a user-selectable self-calibration input that shuts down the device and allows it to be recalibrated at any time. The calibration routine takes 10ms.

Crossover Distortion

These op amps feature a low-noise integrated charge pump that creates an internal voltage rail 1V above V_{DD} , which is used to power the input differential pair of PMOS transistors as shown in [Figure 1](#). Such a unique architecture eliminates crossover distortion common in traditional CMOS input architecture ([Figure 2](#)), especially when used in a noninverting configuration, such as for Sallen-Key filters.

The charge pump's operating frequency lies well above the unity-gain frequency of the amplifier. Thanks to its high-frequency operation and ultra-quiet circuitry, the charge pump generates little noise, does not require external components, and is entirely transparent to the user.

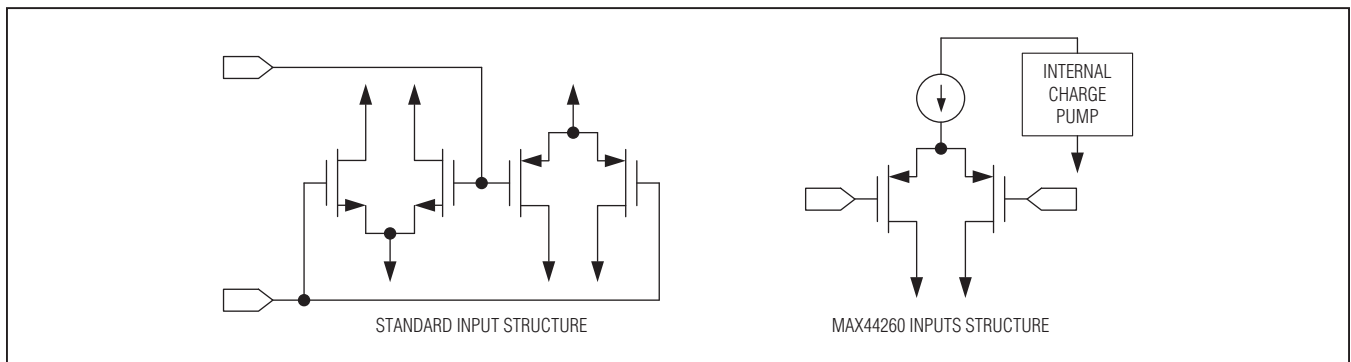

Figure 1. Comparing the Input Structure of the MAX44260 to Standard Op-Amp Inputs

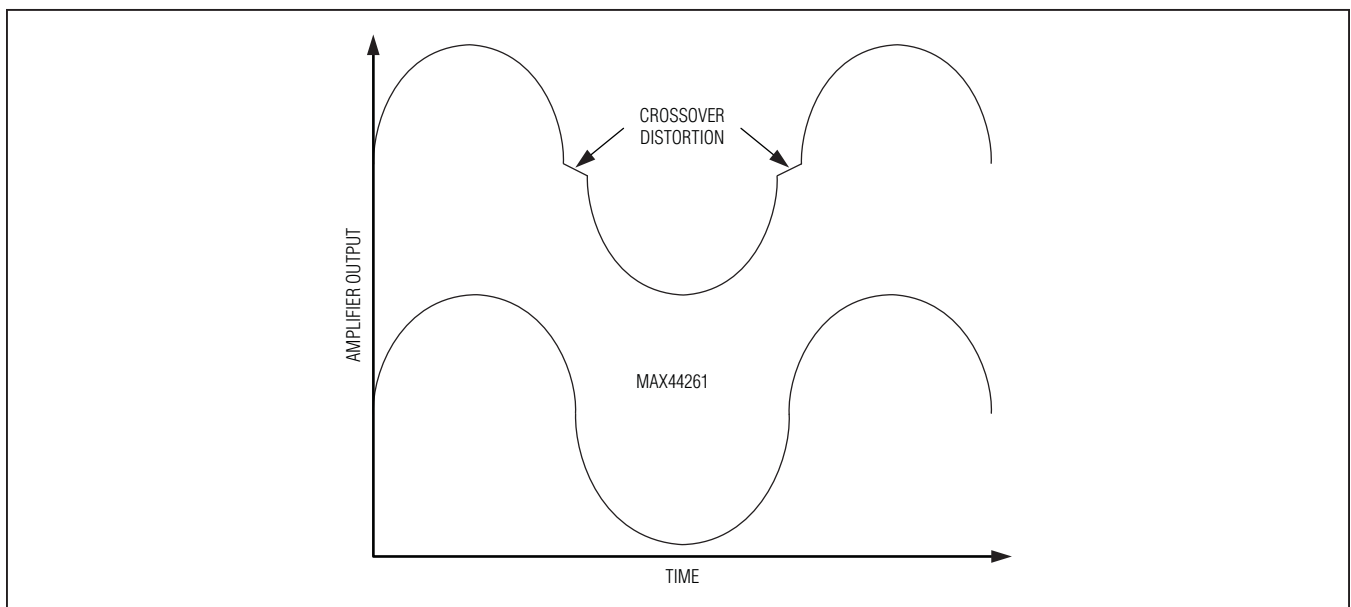

Figure 2. Crossover Distortion of Typical Amplifiers

MAX44260/MAX44261

1.8V 15MHz Low-Offset, Low-Power, Rail-to-Rail I/O Op Amps

Applications Information

Power-Up Autotrim

The ICs feature an automatic trim that self-calibrates the V_{OS} of these devices to less than $50\mu V$ of input offset voltage on power-up. This self-calibration feature allows the device to eliminate input offset voltage effects due to power supply and operating temperature variation simply by cycling its power. The autotrim sequence takes approximately 10ms to complete and is triggered by an internal power-on-reset (POR) circuitry. During this time, the inputs and outputs are put into high impedance and left unconnected. The MAX44261 can also be forced into a self-calibration cycle by pulling the \overline{CAL} input low for $1\mu s$. This input also puts the part into shutdown mode.

Shutdown Operation

The MAX44260 features an active-low shutdown mode that puts both inputs and outputs into high impedance and substantially lowers the quiescent current to less than $1\mu A$. Putting the output into high impedance allows multiple outputs to be multiplexed onto a single output line without the additional external buffers. The device does not self-calibrate when exiting shutdown mode

and retains its power-up trim settings. Figure 3 shows that the device also recovers from shutdown in under $30\mu s$.

The MAX44261 features a recalibrate input that acts the same as the shutdown mode of the MAX44260. However, when the input is pulled low, the device goes through a self-calibration sequence again (Figure 3).

The shutdown logic levels of the devices are independent of supply, allowing the shutdown feature of the device to operate off of a 1.8V or 3.3V microcontroller, regardless of supply voltage.

Rail-to-Rail Input/Output

The input voltage range of the ICs extends $100mV$ above V_{DD} and below V_{SS} . The wide input common-mode voltage range allows the op amp to be used as a buffer and as a differential amplifier in a wide-variety of signal processing applications. Output voltage high/low is designed to be only $50mV$ above V_{SS} and below V_{DD} allowing maximum dynamic range in single-supply applications. The high output current and capacitance drive capability of the devices make them ideal as an ADC driver and a line driver.

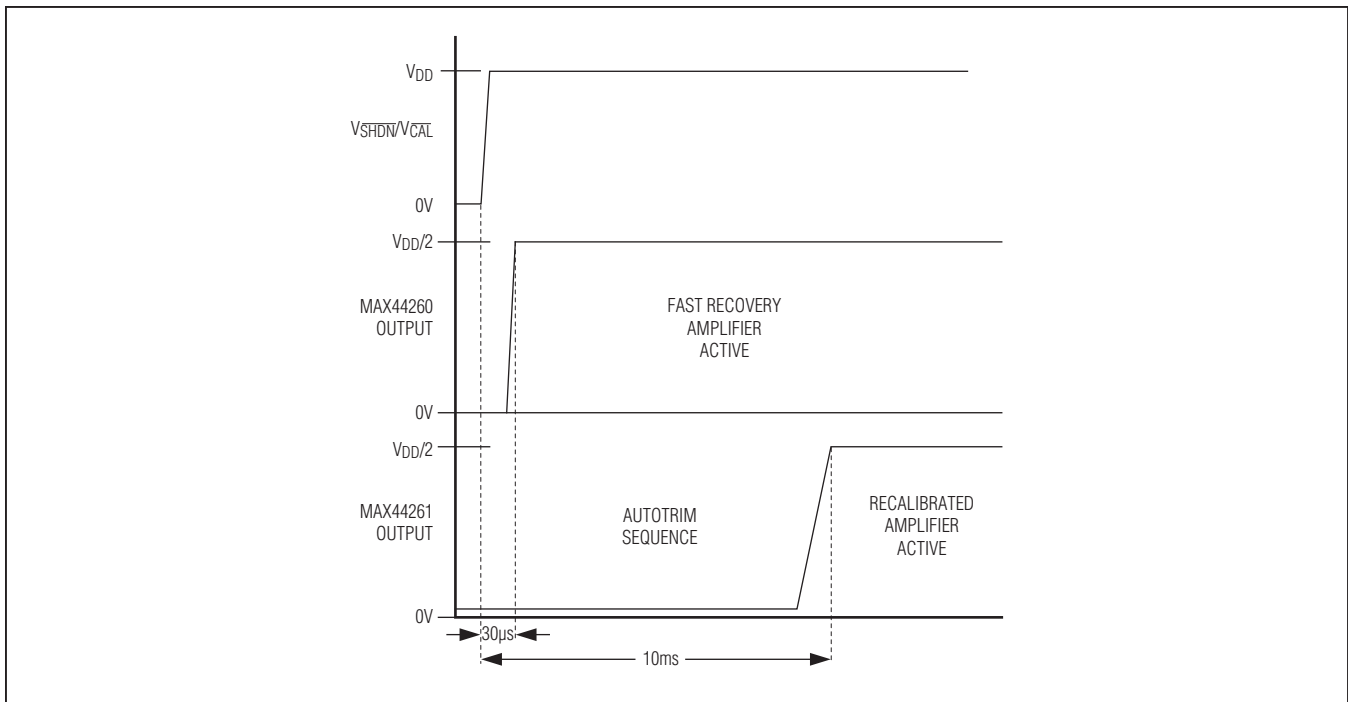

Figure 3. \overline{CAL} vs. \overline{SHDN} Input Operation.

MAX44260/MAX44261

1.8V 15MHz Low-Offset, Low-Power, Rail-to-Rail I/O Op Amps

Input Bias Current

The ICs feature a high-impedance CMOS input stage and a specialized ESD structure that allows low-input bias current operation at low-input, common-mode voltages. Low-input bias current is useful when interfacing with high-ohmic sensors. It is also beneficial for designing transimpedance amplifiers for photodiode sensors. This makes these devices ideal for ground-referenced medical and industrial sensor applications.

Active Filters

The MAX44260/MAX44261 are ideal for a wide variety of active filter circuits that make use of their wide bandwidth, rail-to-rail input/output stages and high-impedance CMOS inputs. The [Typical Application Circuit](#) shows an example Sallen-Key active filter circuit with a corner frequency of 10kHz. At low frequencies, the amplifier behaves like a simple low-distortion noninverting buffer, while its high bandwidth gives excellent stopband attenuation above its corner frequency. See the [Typical Application Circuit](#).

Chip Information

PROCESS: BiCMOS

Driver for Interfacing with the MAX11645 ADC

The ICs' tiny size and low noise makes them a good fit for driving 12- to 16-bit resolution ADCs in space-constrained applications. The [Typical Application Circuit](#) shows the MAX44260 amplifier output connected to a lowpass filter driving the MAX11645 ADC. The MAX11645 is part of a family of 3V and 5V, 12-bit and 10-bit, 2-channel ADCs.

The MAX11645 offers sample rates up to 94ksps and measures two single-ended inputs or one differential input. These ADCs dissipate 670 μ A at the maximum sampling rate, but just 6 μ A at 1ksps and 0.5 μ A in shut-down. Offered in the ultra-tiny, 1.9mm x 2.2mm WLP and μ MAX-8 packages, the MAX11645 ADCs are an ideal fit to pair with the MAX44260/MAX44261 amplifiers in portable applications.

Where higher resolution is required, refer to the MAX1069 (14-bit) and MAX1169 (16-bit) ADC families.

Ordering Information

PART	TEMP RANGE	PIN-PACKAGE	TOP MARK
MAX44260AXT+	-40°C to +125°C	6 SC70	+AEB
MAX44260AYT+	-40°C to +125°C	6 Thin μ DFN (Ultra-Thin LGA)	+AY
MAX44261AXT+	-40°C to +125°C	6 SC70	+AEC

+Denotes a lead(Pb)-free/RoHS-compliant package.

MAX44260/MAX44261

1.8V 15MHz Low-Offset, Low-Power, Rail-to-Rail I/O Op Amps

Package Information

For the latest package outline information and land patterns (footprints), go to www.maxim-ic.com/packages. Note that a "+", "#", or "-" in the package code indicates RoHS status only. Package drawings may show a different suffix character, but the drawing pertains to the package regardless of RoHS status.

PACKAGE TYPE	PACKAGE CODE	OUTLINE NO.	LAND PATTERN NO.
6 SC70	X6SN+1	21-0077	90-0189
6 Thin μ DFN (Ultra-Thin LGA)	Y61A1+1	21-0190	90-0233

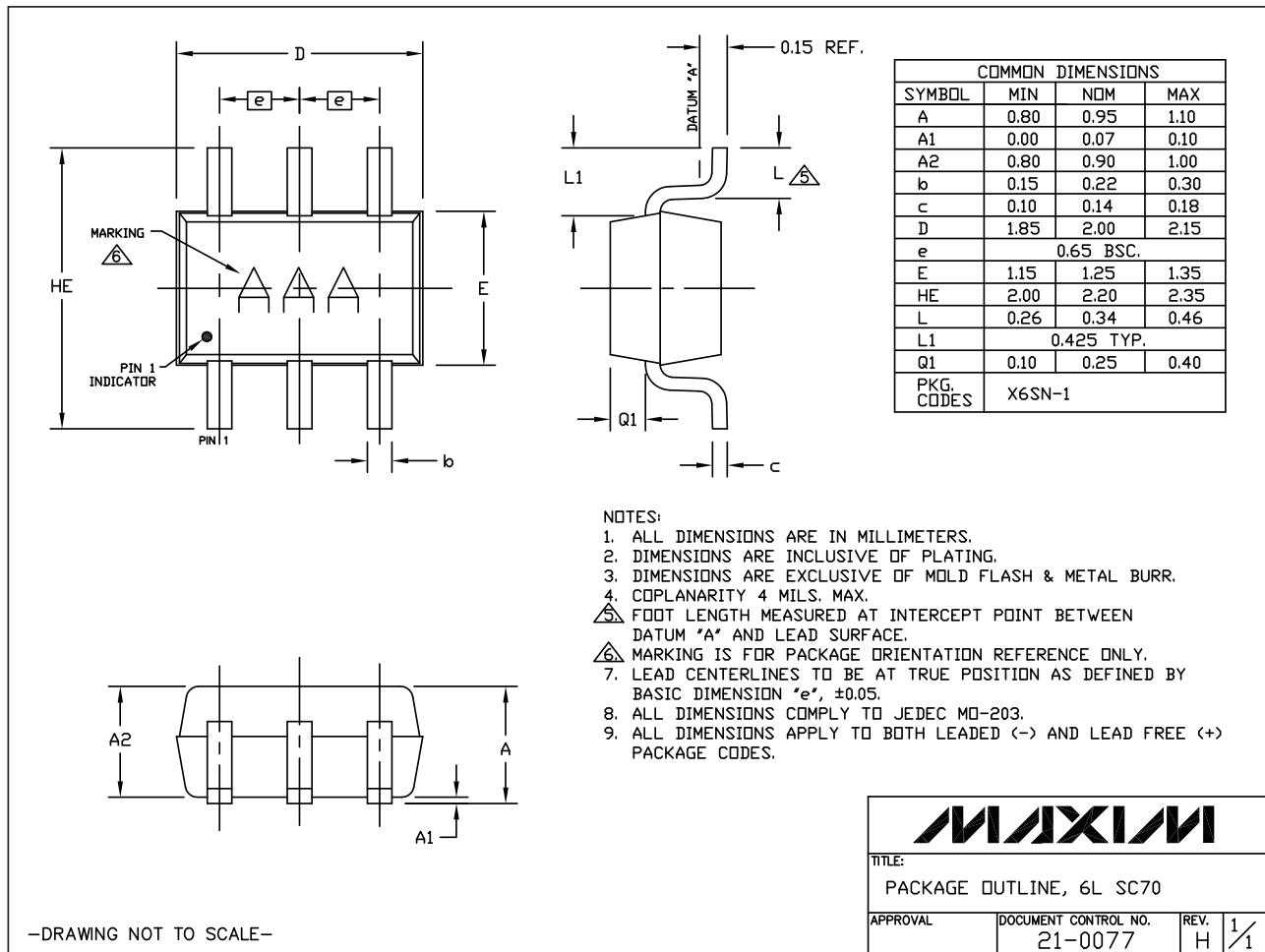

MAX44260/MAX44261

1.8V 15MHz Low-Offset, Low-Power, Rail-to-Rail I/O Op Amps

Package Information (continued)

For the latest package outline information and land patterns (footprints), go to www.maxim-ic.com/packages. Note that a "+", "#", or "-" in the package code indicates RoHS status only. Package drawings may show a different suffix character, but the drawing pertains to the package regardless of RoHS status.

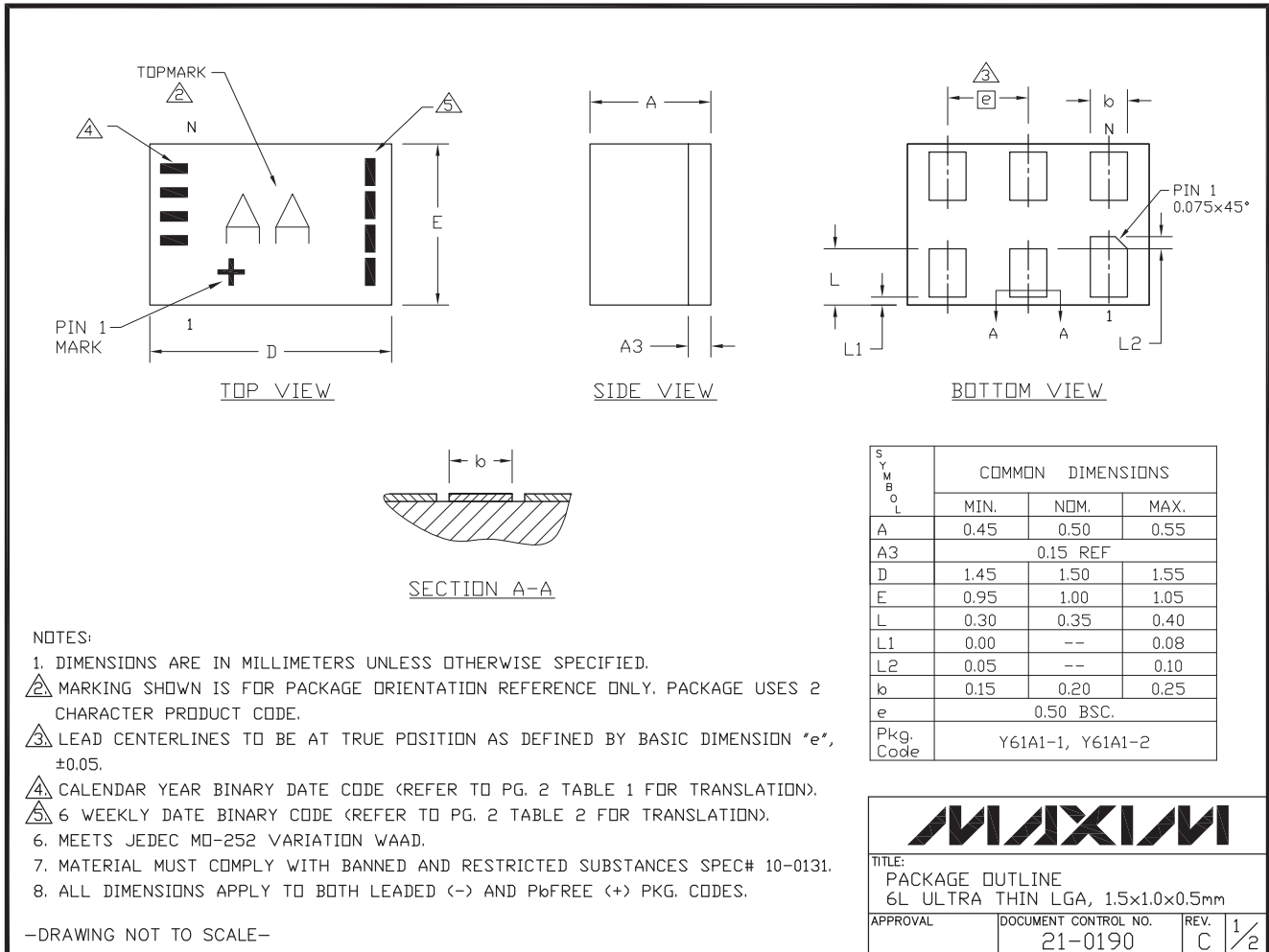

MAX44260/MAX44261

1.8V 15MHz Low-Offset, Low-Power, Rail-to-Rail I/O Op Amps

Package Information (continued)

For the latest package outline information and land patterns (footprints), go to www.maxim-ic.com/packages. Note that a "+", "#", or "-" in the package code indicates RoHS status only. Package drawings may show a different suffix character, but the drawing pertains to the package regardless of RoHS status.

TABLE 1 Translation Table for Calendar Year Code

Calendar Year	2005	2006	2007	2008	2009	2010	2011	2012	2013	2014
	□	□	□	■	□	□	■	□	■	■
	□	□	■	□	□	■	□	■	□	□
	□	■	□	□	■	□	□	■	■	■
	■	□	□	□	■	■	■	□	□	□

Legend: Marked with bar Blank space - no bar required

TABLE 2 Translation Table for Payweek Binary Coding

Payweek	06-11	12-17	18-23	24-29	30-35	36-41	42-47	48-51	52-05
	□	□	□	■	□	□	■	□	■
	□	□	■	□	□	■	□	■	□
	□	■	□	□	■	□	□	■	■
	■	□	□	□	■	■	■	□	□

Legend: Marked with bar Blank space - no bar required



TITLE:
PACKAGE OUTLINE
6L ULTRA THIN LGA, 1.5x1.0x0.5mm

APPROVAL	DOCUMENT CONTROL NO. 21-0190	REV. C	2/2
----------	---------------------------------	-----------	-----

-DRAWING NOT TO SCALE-

MAX44260/MAX44261

1.8V 15MHz Low-Offset, Low-Power, Rail-to-Rail I/O Op Amps

Revision History

REVISION NUMBER	REVISION DATE	DESCRIPTION	PAGES CHANGED
0	6/11	Initial release	—
1	8/11	Added thin μ DFN (ultra-thin LGA) package and updated slew rate and TOC 29	1, 2, 3, 8, 9, 12
2	10/11	Removed future product information from data sheet	12
3	2/12	Revised <i>Electrical Characteristics</i> and the <i>Power-Up Autotrim</i> section.	2, 3, 11

Maxim cannot assume responsibility for use of any circuitry other than circuitry entirely embodied in a Maxim product. No circuit patent licenses are implied. Maxim reserves the right to change the circuitry and specifications without notice at any time. The parametric values (min and max limits) shown in the Electrical Characteristics table are guaranteed. Other parametric values quoted in this data sheet are provided for guidance.

Maxim Integrated Products, 120 San Gabriel Drive, Sunnyvale, CA 94086 408-737-7600 _____ **16**