



TYN606 TYN1006

STANDARD

6A SCRs

Table 1: Main Features

Symbol	Value	Unit
$I_{T(RMS)}$	6	A
V_{DRM}/V_{RRM}	600 and 1000	V
I_{GT}	15	mA

DESCRIPTION

The **TYN606** and **TYN1006** family of Silicon Controlled Rectifiers are high performance glass passivated technology.

This general purpose Family of Silicon Controlled Rectifiers is designed for power supply up to 400Hz on resistive or inductive load.

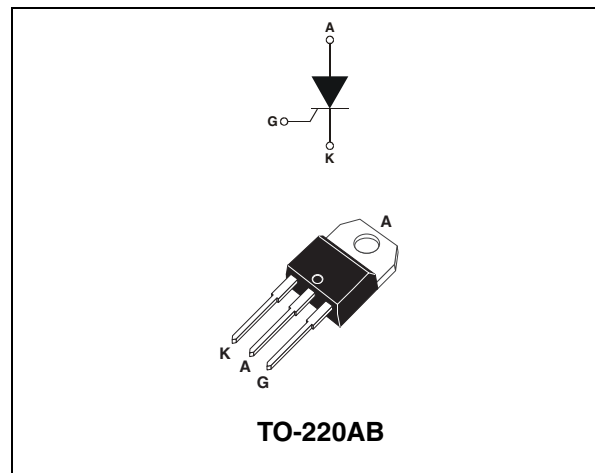

Table 2: Order Codes

Part Numbers	Marking
TYN606RG	TYN606
TYN1006RG	TYN1006

Table 3: Absolute Ratings (limiting values)

Symbol	Parameter		Value	Unit
$I_{T(RMS)}$	RMS on-state current (180° conduction angle)		$T_c = 110^\circ\text{C}$ 6	A
$I_{T(AV)}$	Average on-state current (180° conduction angle)		$T_c = 110^\circ\text{C}$ 3.8	A
I_{TSM}	Non repetitive surge peak on-state current	$t_p = 8.3 \text{ ms}$	$T_j = 25^\circ\text{C}$ 73	A
		$t_p = 10 \text{ ms}$		
I^2t	I^2t Value for fusing	$t_p = 10 \text{ ms}$	$T_j = 25^\circ\text{C}$ 24.5	A^2s
di/dt	Critical rate of rise of on-state current $I_G = 100 \text{ mA}$, $di_G/dt = 0.1 \text{ A}/\mu\text{s}$		$T_j = 125^\circ\text{C}$ 50	$\text{A}/\mu\text{s}$
I_{GM}	Peak gate current	$t_p = 20 \mu\text{s}$	$T_j = 125^\circ\text{C}$ 4	A
$P_{G(AV)}$	Average gate power dissipation		$T_j = 125^\circ\text{C}$ 1	W
P_{GM}	Maximum gate power	$t_p = 20 \mu\text{s}$	$T_j = 125^\circ\text{C}$ 10	W
V_{DRM} V_{RRM}	Repetitive peak off-state voltage		TYN606 $T_j = 125^\circ\text{C}$ 600	V
			TYN1006 1000	
T_{stg} T_j	Storage junction temperature range Operating junction temperature range		- 40 to + 150 - 40 to + 125	$^\circ\text{C}$
T_L	Maximum lead temperature for soldering during 10s at 2mm from case		260	$^\circ\text{C}$

Tables 4: Electrical Characteristics ($T_j = 25^\circ\text{C}$, unless otherwise specified)

Symbol	Test Conditions		Value	Unit		
I_{GT}	$V_D = 12\text{ V (D.C.)}$ $R_L = 33\ \Omega$		MAX.	15	mA	
V_{GT}			MAX.	1.5	V	
V_{GD}	$V_D = V_{DRM}$ $R_L = 3.3\ \text{k}\Omega$	$T_j = 110^\circ\text{C}$	MIN.	0.2	V	
t_{gt}	$V_D = V_{DRM}$ $I_G = 40\ \text{mA}$ $di_G/dt = 0.5\ \text{A}/\mu\text{s}$		TYP.	2	μs	
I_H	$I_T = 100\ \text{mA}$ Gate open		MAX.	30	mA	
I_L	$I_G = 1.2 \times I_{GT}$		TYP.	50	mA	
dV/dt	Linear slope up to: $V_D = 67\% V_{DRM}$ Gate open	$T_j = 110^\circ\text{C}$	MIN.	200	$\text{V}/\mu\text{s}$	
V_{TM}	$I_{TM} = 12\ \text{A}$ $t_p = 380\ \mu\text{s}$		MAX.	1.6	V	
I_{DRM} I_{RRM}	$V_{DRM} = V_{RRM}$	$T_j = 25^\circ\text{C}$	MAX.	10	μA	
		$T_j = 110^\circ\text{C}$		2	mA	
t_q	$V_D = 67\% V_{DRM}$ $I_{TM} = 12\ \text{A}$ $V_R = 25\ \text{V}$ $dI_{TM}/dt = 30\ \text{A}/\mu\text{s}$ $dV_D/dt = 50\ \text{V}/\mu\text{s}$		$T_j = 110^\circ\text{C}$	TYP.	70	μs

Table 5: Thermal Resistance

Symbol	Parameter	Value	Unit
$R_{th(j-c)}$	Junction to case (D.C.)	2.5	$^\circ\text{C}/\text{W}$
$R_{th(j-a)}$	Junction to ambient	60	$^\circ\text{C}/\text{W}$

Figure 1: Maximum average power dissipation versus average on-state current

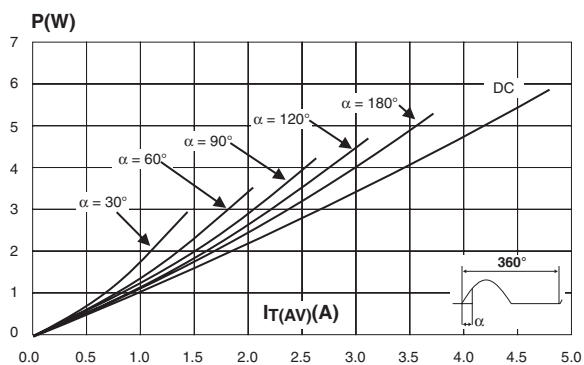

Figure 2: Correlation between maximum average power dissipation and maximum allowable temperature (T_{amb} and T_{lead})

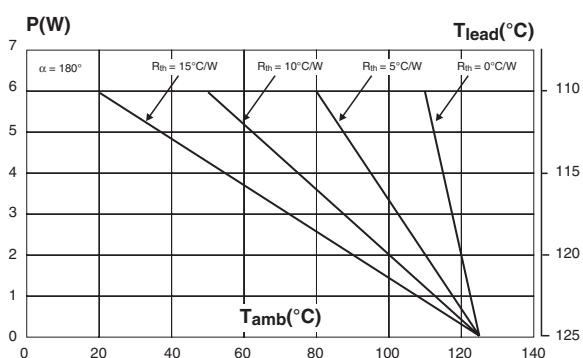

Figure 3: Average on-state current versus case temperature

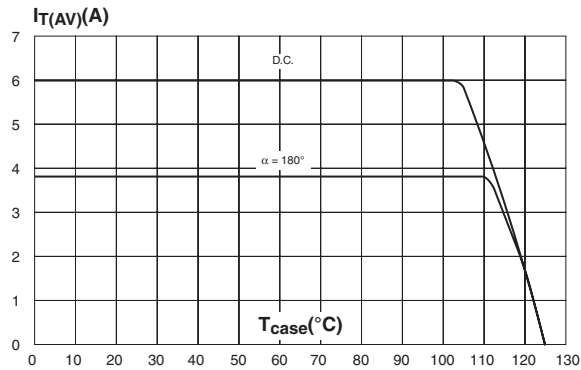

Figure 4: Relative variation of thermal impedance versus pulse duration

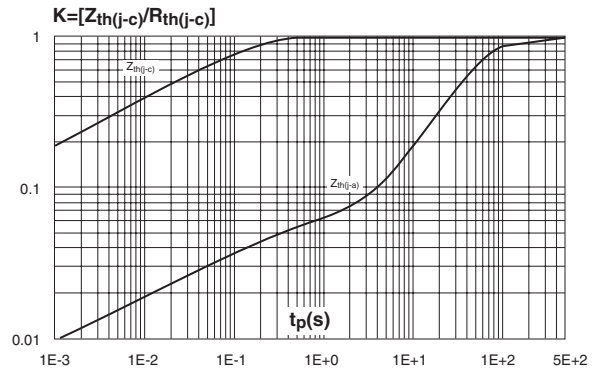

Figure 5: Relative variation of gate trigger current versus junction temperature

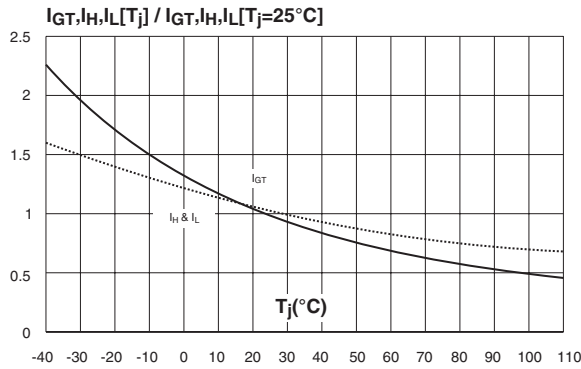

Figure 6: Surge peak on-state current versus number of cycles

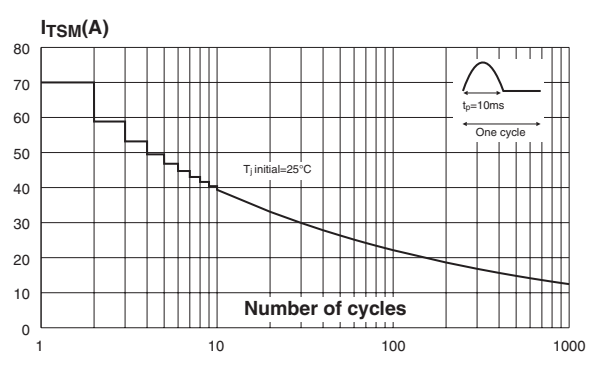

Figure 7: Non-repetitive surge peak on-state current for a sinusoidal pulse with width t_p < 10 ms, and corresponding values of I^2t

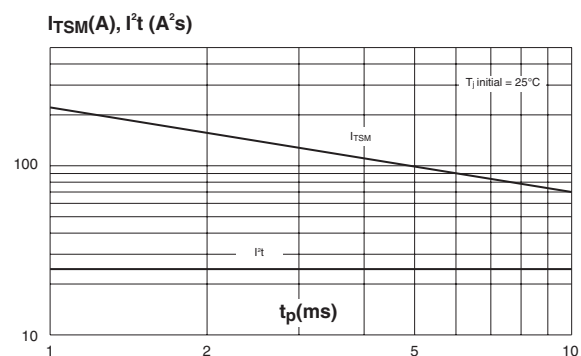

Figure 8: On-state characteristics (maximum values)

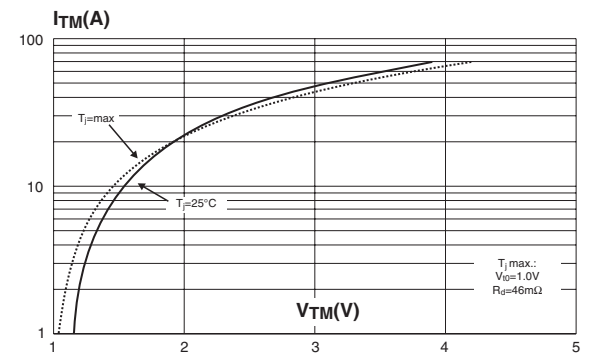

Figure 9: Ordering Information Scheme

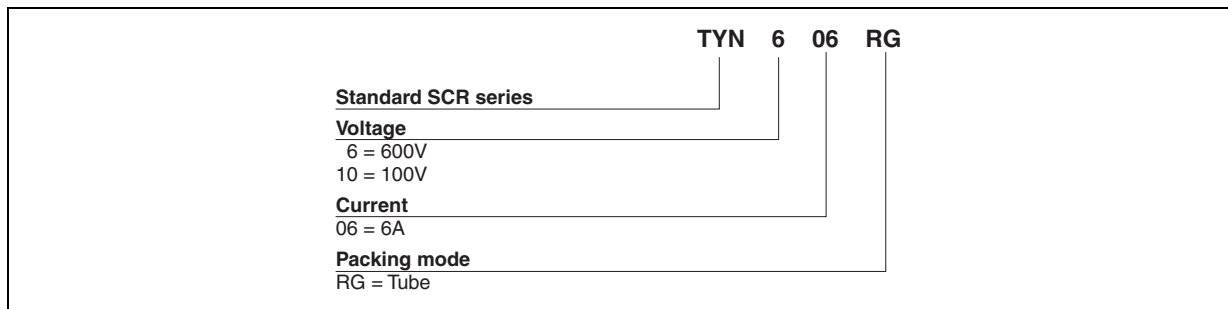
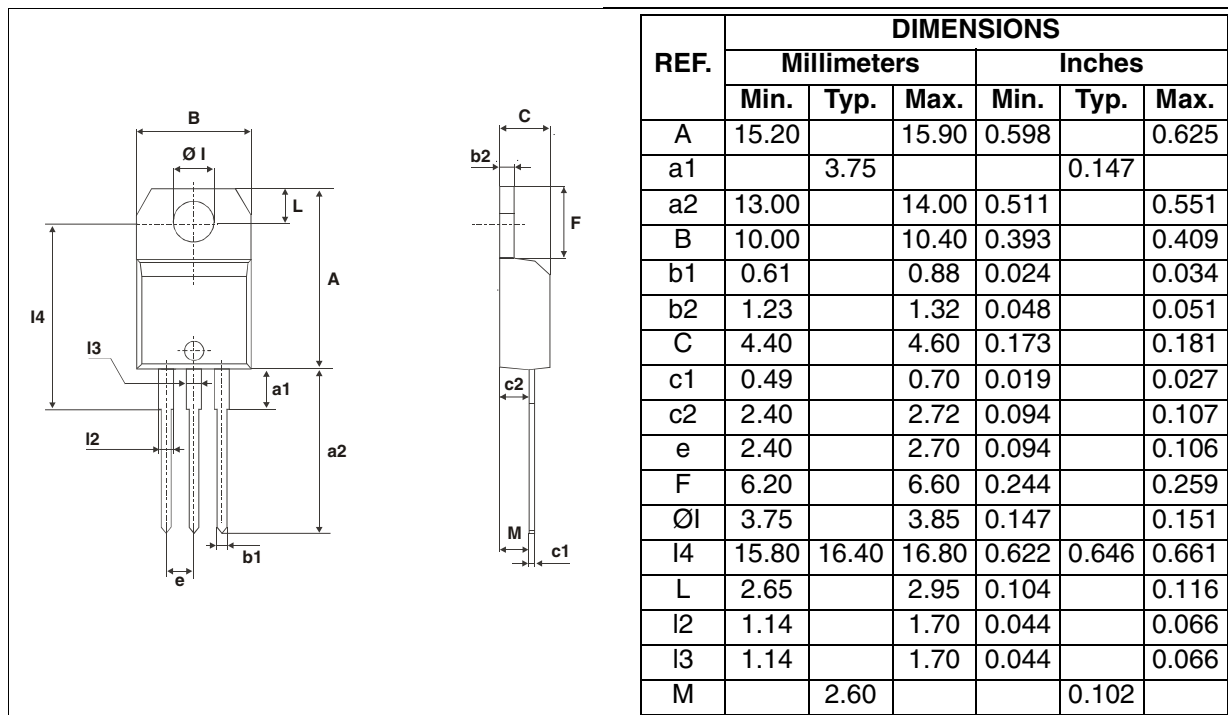

Table 6: Product Selector

Part Numbers	Voltage (xx)		Sensitivity	Package
	600 V	1000 V		
TYN606RG	X		15 mA	TO-220AB
TYN1006RG		X	15 mA	TO-220AB

Figure 10: TO-220AB Package Mechanical Data



In order to meet environmental requirements, ST offers these devices in ECOPACK® packages. These packages have a Lead-free second level interconnect . The category of second level interconnect is marked on the package and on the inner box label, in compliance with JEDEC Standard JESD97. The maximum ratings related to soldering conditions are also marked on the inner box label. ECOPACK is an ST trademark. ECOPACK specifications are available at: www.st.com.

Table 7: Ordering Information

Ordering type	Marking	Package	Weight	Base qty	Delivery mode
TYN606RG	TYN606	TO-220AB	2.3 g	50	Tube
TYN1006RG	TYN1006				

Table 8: Revision History

Date	Revision	Description of Changes
Sep-2001	1A	First issue.
13-Feb-2006	2	TO-220AB delivery mode changed from bulk to tube. ECOPACK statement added.

Information furnished is believed to be accurate and reliable. However, STMicroelectronics assumes no responsibility for the consequences of use of such information nor for any infringement of patents or other rights of third parties which may result from its use. No license is granted by implication or otherwise under any patent or patent rights of STMicroelectronics. Specifications mentioned in this publication are subject to change without notice. This publication supersedes and replaces all information previously supplied. STMicroelectronics products are not authorized for use as critical components in life support devices or systems without express written approval of STMicroelectronics.

The ST logo is a registered trademark of STMicroelectronics.
All other names are the property of their respective owners

© 2006 STMicroelectronics - All rights reserved

STMicroelectronics group of companies

Australia - Belgium - Brazil - Canada - China - Czech Republic - Finland - France - Germany - Hong Kong - India - Israel - Italy - Japan -
Malaysia - Malta - Morocco - Singapore - Spain - Sweden - Switzerland - United Kingdom - United States of America
www.st.com