

The Q2L SIDACTor series provides bidirectional transient voltage protection in a low profile, chip scale package. The small package QFN (Quad Flatpak No-Lead) is ideal for dense board applications such as line cards, modems, phones, fax machines, and other telecommunication equipment.

Features:

- RoHS compliant
- Chip Scale Package (CSP) sizing
- Wide range of I_{PP} ratings including:
 - 75A for 5x310/10x700 μ s ITU/YDT waveform
 - 80A for 10x1000 μ s GR 1089 waveform
 - 100A for 10x560 μ s TIA-968
- Bidirectional transient voltage protection
- Small footprint (QFN)
- Teccor® brand SIDACTor technology
- Recognized under UL E133083 file number

Protection solution to meet:

- YD/T 950
 - YD/T 993
 - YD/T 1082
 - GR 1089 Inter-building
 - IEC 61000-4-5
 - ITU K.20/21
 - TIA/EIA-IS-968
- Basic Recommendations

Electrical Parameters

Part Number	Marking XXXX	V_{DRM} @ $I_{DRM}=5\mu A$	V_S @100V/ μ s	I_H	I_S	I_T	V_T @ $I_T=1$ amp	Capacitance @1MHz, 2V bias	
		Volts	Volts	mAmps	mAmps	Amps	Volts	pF	
		Min	Max	Min			Max	Min	Max
P0080Q12ALRP	P-8A	6	25	50	800	2.2	5	25	55
P0300Q12ALRP	P03A	25	40	50	800	2.2	5	15	35
P0640Q12ALRP	P06A	58	77	150	800	2.2	5	40	60
P0720Q12ALRP	P07A	65	88	150	800	2.2	5	40	60
P0900Q12ALRP	P09A	75	98	150	800	2.2	5	35	55
P1100Q12ALRP	P11A	90	130	150	800	2.2	5	30	50
P1300Q12ALRP	P13A	120	160	150	800	2.2	5	25	45
P1500Q12ALRP	P15A	140	180	150	800	2.2	5	25	40
P1800Q12ALRP	P18A	170	220	150	800	2.2	5	25	35
P2300Q12ALRP	P23A	190	260	150	800	2.2	5	25	35
P2600Q12ALRP	P26A	220	300	150	800	2.2	5	25	35
P3100Q12ALRP	P31A	275	350	150	800	2.2	5	20	35
P3500Q12ALRP	P35A	320	400	150	800	2.2	5	20	30
P0080Q12BLRP	P08B	6	25	50	800	2.2	5	25	55
P0300Q12BLRP	P03B	25	40	50	800	2.2	5	15	35
P0640Q12BLRP	P06B	58	77	150	800	2.2	5	40	60
P0720Q12BLRP	P07B	65	88	150	800	2.2	5	40	60
P0900Q12BLRP	P09B	75	98	150	800	2.2	5	35	55
P1100Q12BLRP	P11B	90	130	150	800	2.2	5	30	50
P1300Q12BLRP	P13B	120	160	150	800	2.2	5	25	45
P1500Q12BLRP	P15B	140	180	150	800	2.2	5	25	40
P1800Q12BLRP	P18B	170	220	150	800	2.2	5	25	35
P2300Q12BLRP	P23B	190	260	150	800	2.2	5	25	35
P2600Q12BLRP	P26B	220	300	150	800	2.2	5	25	35
P3100Q12BLRP	P31B	275	350	150	800	2.2	5	20	35
P3500Q12BLRP	P35B	320	400	150	800	2.2	5	20	30

- All measurements are made at an ambient temperature of 25°C. I_{PP} applies to -40°C through +85°C temperature range.
- I_{PP} is a repetitive surge rating and is guaranteed for the life of the product.
- Listed SIDACTor devices are bidirectional. All electrical parameters and surge ratings apply to forward and reverse polarities.
- V_S is measured at 100 V/ μ s.
- Off-state capacitance is measured at 1MHz with a 2 V bias and is a typical value for "A" and "B" rated product.

Surge Ratings

Series	I _{pp}					I _{TSM}	di/dt
	2x10μs	1.2x50μs/8x20μs	10x160μs	10x560μs	10x1000μs	AC 60Hz	
	Amps	Amps	Amps	Amps	Amps	Amps	Amps/μs
	Min	Min	Min	Min	Min	Min	Max
A	150	150	90	50	45	20	500
B	250	250	150	100	80	20	500

Thermal Considerations

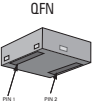
Package	Symbol	Parameter	Value	Unit
 QFN	T _J	Operating Junction Temperature Range	-40 to +150	°C
	T _S	Storage Temperature Range	-65 to +150	°C
	R _{θJA}	Thermal Resistance: Junction to Ambient	120	°C/W

V-I: Characteristics

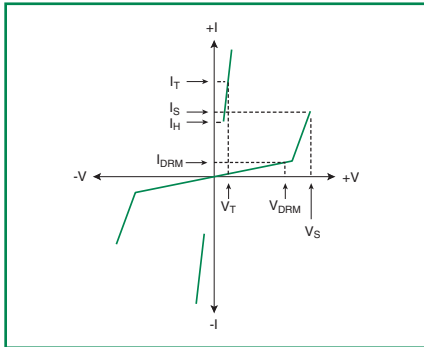

V-I: Pulse Wave-form

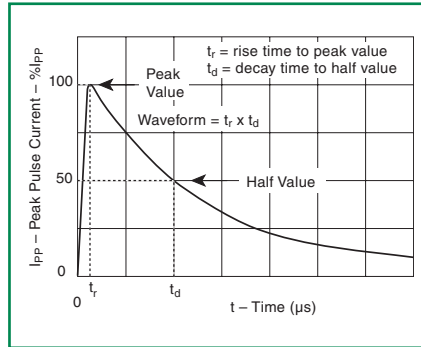

V-I: Junction Temperature

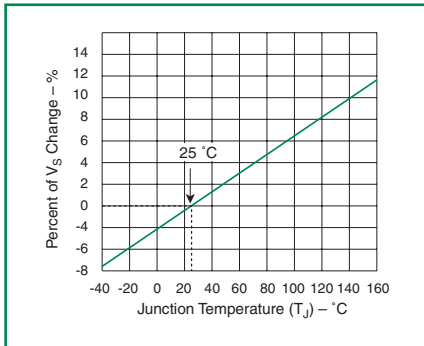

V-I: Holding Current/Case Temperature

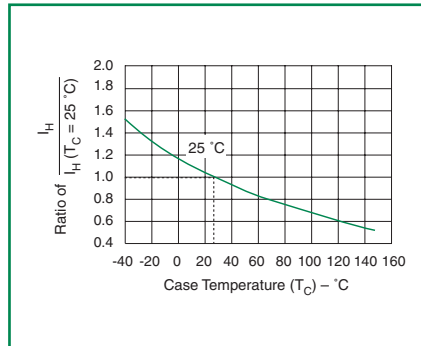

Part Numbering

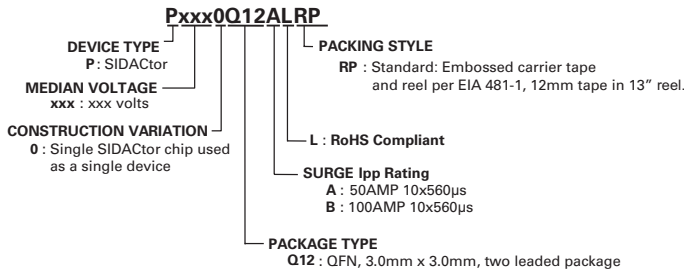

Device Marking

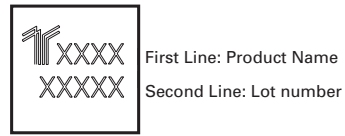

Mechanical Drawings and Recommended Solder Pad Outline

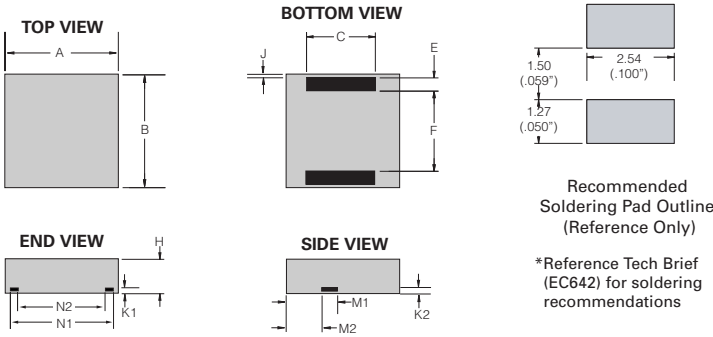

Mechanical Dimensions

Dimensions	Inches			Millimeters		
	Min	Typ	Max	Min	Typ	Max
A	0.114	0.118	0.122	2.900	3.000	3.100
B	0.114	0.118	0.122	2.900	3.000	3.100
C	0.075	0.079	0.083	1.900	2.000	2.100
E	0.011	0.015	0.019	0.285	0.385	0.485
F	0.076	0.080	0.084	1.930	2.030	2.130
H	0.035	0.039	0.043	0.900	1.000	1.100
J	0.000	0.004	0.008	0.000	0.100	0.200
K1	0.004	0.008	0.012	0.100	0.200	0.300
K2	0.004	0.008	0.012	0.100	0.200	0.300
M1	0.056	0.060	0.064	1.430	1.530	1.630
M2	0.038	0.042	0.046	0.970	1.070	1.170
N1	0.096	0.100	0.104	2.440	2.540	2.640
N2	0.082	0.086	0.090	2.080	2.180	2.280

Data Sheets

Tape and Reel Dimensional Drawings

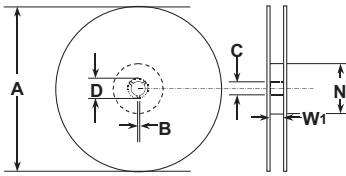

Reel Dimension

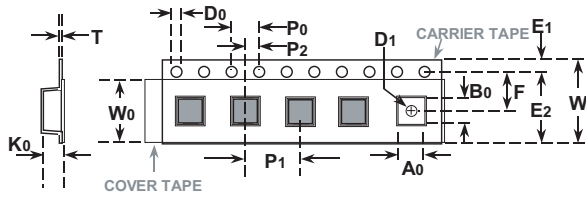

Tape Dimension Items

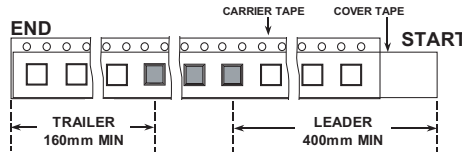

Tape Leader and Trailer Dimensions

Tape and Reel Dimensions

Symbols	Description	Inches		Millimeters	
		Minimum	Maximum	Minimum	Maximum
A	Reel Diameter	N/A	12.992	N/A	330.0
B	Drive Spoke Width	0.059	N/A	1.50	N/A
C	Arbor Hole Diameter	0.504	0.531	12.80	13.50
D	Drive Spoke Diameter	0.795	N/A	20.20	N/A
N	Hub Diameter	1.969	N/A	50.00	N/A
W1	Reel Inner Width at Hub	0.488	0.567	12.40	14.40
A0	Pocket Width at bottom	0.126	0.134	3.20	3.40
B0	Pocket Length at bottom	0.126	0.134	3.20	3.40
D0	Feed Hole Diameter	0.059	0.063	1.50	1.60
D1	Pocket Hole Diameter	0.059	N/A	1.50	N/A
E1	Feed hole position 1	0.065	0.073	1.65	1.85
E2	Feed hole position 2	0.400	0.408	10.15	10.35
F	Feed hole center-Pocket hole	0.215	0.219	5.45	5.55
K0	Pocket Depth	0.039	0.051	1.00	1.30
P0	Feed Hole Pitch	0.153	0.161	3.90	4.10
P1	Component Spacing	0.311	0.319	7.90	8.10
P2	Feed hole center-Pocket hole	0.077	0.081	1.95	2.05
T	Carrier Tape Thickness	0.010	0.014	0.25	0.35
W	Embossed Carrier Tape Width	0.453	0.484	11.50	12.30
W0	Cover Tape Width	0.358	0.366	9.10	9.30