

**Revision**

**1.5.0**



# **Wi.232DTS-R / Wi.232DTSB-R DATASHEET**

RADIOTRONIX, INC.

# **WI.232DTS-R / WI.232DTSB-R DATASHEET**

---

© Radiotronics  
905 Messenger Lane  
Moore, Oklahoma 73160  
Phone 405.794.7730 • Fax 405.794.7477  
[www.radiotronics.com](http://www.radiotronics.com)

## Document Control

	SIGNED	DATE
<b>CREATED BY</b>	SJM	12/9/2003
<b>ENGINEERING REVIEW</b>		
<b>MARKETING REVIEW</b>	TJE	6/13/2007
<b>APPROVED- ENG.</b>		
<b>APPROVED- MAR.</b>	TJE	6/13/2007

## Revised History

REVISION	SIGNED	DATE	DESCRIPTION
1.0.0	SJM	12/9/2003	Document created
1.2.0	TRM/ GWH	5/12/2004	Various corrections (register addresses)
1.3.0	TRM	6/2/2004	Corrected programming omission
1.3.1	TRM	6/3/2004	Corrected MAC/OUI and NVSLP MODE errors
1.4.0	TRM	6/27/2004	Corrected inconsistencies in register tables
1.4.1	TRM	3/15/2005	Corrected error in register summary table
1.4.2	TRM	10/12/2005	Corrected inconsistencies in LP power values
1.4.3	TRM	11/2/2005	Added regACKONWAKE definitions
1.4.4	TRM	10/15/2006	Various corrections, information on release register
1.4.5	LMK	07/09/2007	Added section on Power Supply Rise Time, corrected Supply Voltage and Sleep Current Consumption values, Corrected inconsistencies in Output Power values.
1.5.0	TRM	2/12/2008	Various corrections including max input level, and additions for Anatel (Brazilian) derivative product.

# Table of Contents

<b>1. INTRODUCTION</b>	<b>6</b>
1.1. MODULE OVERVIEW	6
1.2. FEATURES	6
1.3. APPLICATIONS	7
<b>2. THEORY OF OPERATION</b>	<b>8</b>
2.1. GENERAL	8
2.2. OPERATING STATES	11
2.3. RESETTING MODULE TO FACTORY DEFAULTS	12
2.4. HARDWARE RESET	12
<b>3. APPLICATION INFORMATION</b>	<b>13</b>
3.1. PIN-OUT DIAGRAM	13
3.2. PIN DESCRIPTION	13
3.3. MECHANICAL DRAWINGS	14
3.4. EXAMPLE CIRCUIT	15
3.5. POWER SUPPLY	15
3.5.1. <i>General</i>	15
3.5.2. <i>Rise Time</i>	15
3.6. UART INTERFACE	16
3.7. ANTENNA	16
3.8. LINK BUDGET, TRANSMIT POWER, AND RANGE PERFORMANCE	16
<b>4. MODULE CONFIGURATION</b>	<b>18</b>
4.1. CHANNEL SETTINGS	18
4.2. POWER MODE	19
4.2.1. <i>DTS Mode</i>	19
4.2.2. <i>Low Power (LP) Mode</i>	19
4.3. UART DATA RATE	20
4.4. NETWORK MODE	20
4.5. TRANSMIT WAIT TIMEOUT	21
4.6. NETWORK GROUP	21
4.7. CRC CONTROL	21
4.8. UART MINIMUM TRANSMISSION UNIT	21
4.9. VERBOSE MODE	22
4.10. CSMA ENABLE	22
4.11. SLEEP CONTROL	22
4.12. ACK ON WAKE	23
4.13. MAC ADDRESS	23
4.14. RELEASE NUMBER	23
4.15. REGISTER SUMMARY	24
<b>5. USING CONFIGURATION REGISTERS</b>	<b>25</b>
5.1. CMD PIN	25
5.2. COMMAND FORMATTING	25
<b>5.3. WRITING TO REGISTERS</b>	<b>26</b>
5.4. READING FROM REGISTERS	27
<b>6. ELECTRICAL SPECIFICATIONS</b>	<b>28</b>

6.1.	ABSOLUTE MAXIMUM RATINGS.....	28
6.2.	DETAILED ELECTRICAL SPECIFICATIONS .....	29
6.2.1.	AC Specifications- Rx .....	29
6.2.2.	AC Specifications- Tx.....	29
6.2.3.	DC Specifications.....	30
6.2.4.	Flash Specifications (Non-Volatile Registers).....	30
7.	<b>CUSTOM APPLICATIONS .....</b>	<b>31</b>
8.	<b>ORDERING INFORMATION .....</b>	<b>32</b>
9.	<b>CONTACT INFORMATION.....</b>	<b>32</b>
9.1.	Technical Support .....	32
9.2.	Sales Support.....	32

## Index of Tables

Table 1, Module Pin Descriptions.....	13
Table 2, Wi.232DTS UART Interface Lines.....	16
Table 3, Power Mode Register Settings.....	19
Table 4, DTS Mode Parameters.....	19
Table 5, Low Power Mode Parameters.....	20
Table 6, Data Rate Register Settings.....	20
Table 7, Release Number to Version Number.....	23
Table 8, Register Summary.....	24
Table 9, Write Register Command, value to be written is less than 128 (0x80).....	26
Table 10, Write Register Command, value to be written is greater than or equal to 128 (0x80).....	27
Table 11, Read Register Command.....	27
Table 12, Read Register Module Response for a Valid Register.....	27
Table 13, Absolute Maximum Ratings.....	28
Table 14, AC Specifications- Rx.....	29
Table 15, AC Specifications- Tx.....	29
Table 16, DC Specifications.....	30
Table 17, Flash Specifications (Non-Volatile Registers).....	30

## Table of Figures

Figure 1: Wi.232DTS Block Diagram.....	6
Figure 2: WiSE Block Diagram.....	8
Figure 3: Wi.232DTS Networking Concept.....	9
Figure 4: Rx State Machine.....	11
Figure 5: Tx State Machine.....	12
Figure 6: Pin-out Diagram.....	13
Figure 7: Module Mechanical Drawings.....	14
Figure 8: Wi.232DTS Suggested Footprint.....	14
Figure 9: Evaluation Module Circuit.....	15
Figure 10: Command and CMD Pin Timing.....	25
Figure 11: Command Conversion Code.....	26

# Chapter 1

## 1. Introduction

The Wi.232DTS-R™ module and Wi.232DTSB-R™ variant (collectively referred to as Wi.232DTS™) combine a state-of-the-art low power wireless transceiver with a powerful multipoint-to-multipoint protocol controller to form a transparent wireless communication solution capable of replacing wires in almost any RS-232/422/485 application. With a 115 dB link budget and very low power operation modes, the Wi.232DTS™ module is excellent for AMR, RFID, Home Automation, and any other application requiring long range (1 mile line of sight) and long battery life.

### 1.1. Module Overview

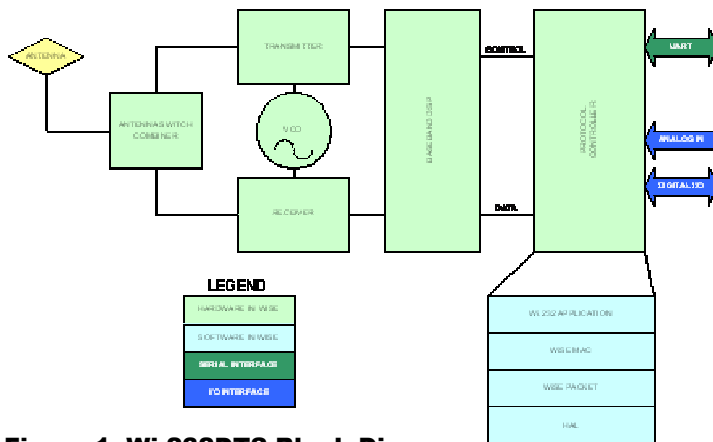

Figure 1: Wi.232DTS Block Diagram

### 1.2. Features

- True UART to antenna solution
- 16-bit CRC error checking
- 100kbit/ sec maximum effective RF data rate
- 32 channels in DTS mode, 84 channels in LP mode, North American Version
- 19 unique channels in DTS mode, 52 unique channels in LP mode, Brazilian Version
- Small size- .8" x .935" x .08"
- Low power Standby and Sleep modes
- PHY and MAC layer protocol built in
- CSMA medium access control

- 115dB link budget in DTS mode
- 4 modes allow user to optimize power/ range
- Command mode for volatile and non-volatile configuration
- 48-bit unique MAC address
- 5 volt tolerant I/O
- 868 – 870 MHz European version available

## **1.3. Applications**

- Direct RD-232/422/485 Wire replacement (requires external RS-232 to 3V CMOS conversion circuitry)
- Asset tracking
- Automated meter reading
- Industrial and/ or Home automation
- RFID
- Wireless sensors
- Remote data logging
- Fleet management



# Chapter 2

## 2. Theory of Operation

### 2.1. General

The Wi.232™ module is one of a family of WiSE™ (Wireless Serial Engine) modules. A WiSE™ module combines a state-of-the-art DTS/FSK data transceiver and a high-performance protocol controller to create a complete embedded wireless communications link in a tiny IC-style package.

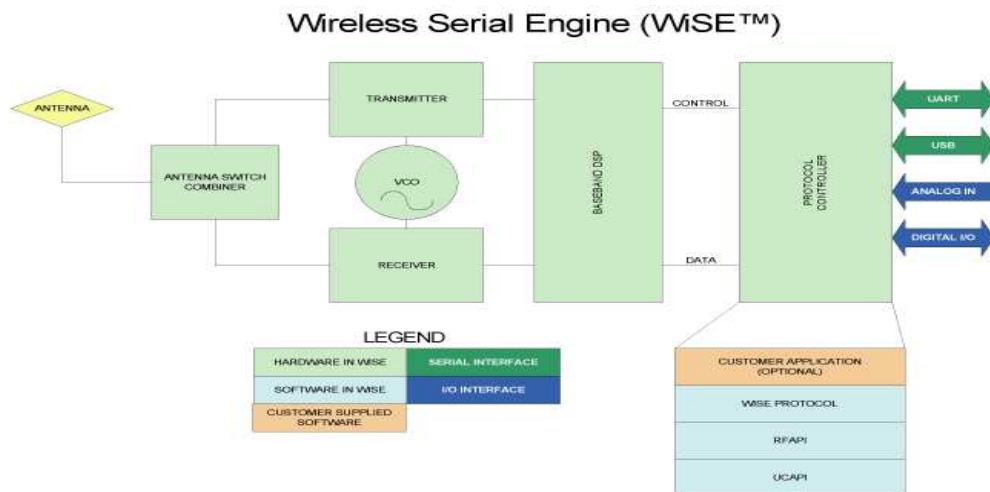

**Figure 2: WiSE Block Diagram**

The Wi.232DTS™ module has a UART-type serial interface and contains special application software to create a transparent UART-to-antenna wireless solution capable of direct wire replacement in most embedded RS-232/422/485 applications.

**Note:** Although the module is capable of supporting the typical serial communications required by RS-232, RS-422, and RS-485 networks, it is not compatible with the electrical interfaces for these types of networks. The module has CMOS inputs and outputs and would require an appropriate converter for the particular type of network it is connected to.

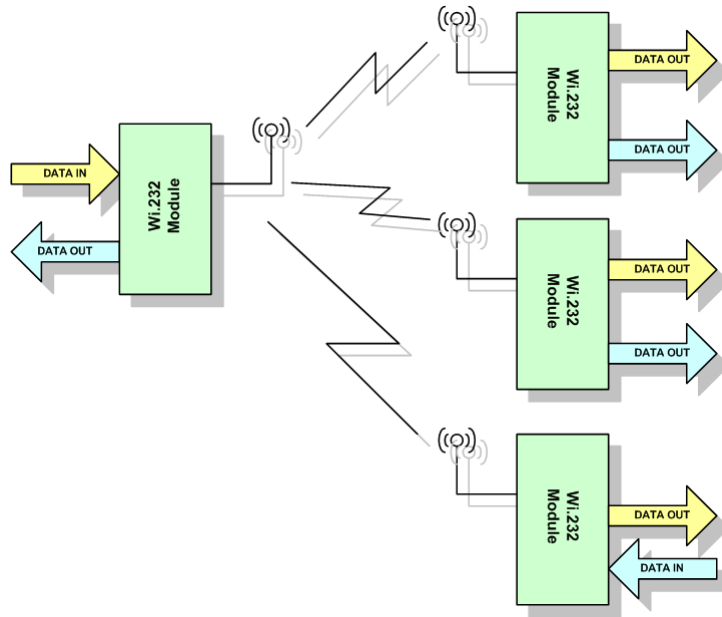

**Figure 3: Wi.232DTS Networking Concept**

The module is designed to interface directly to a host UART. Three signals are used to transfer data between the module and the host UART: **TXD**, **RXD**, and **CTS**. **TXD** is the data output from the module. **RXD** is the data input to the module. **CTS** data output indicates the status of the module's data interface. If **CTS** is low, the module is ready to accept data. If **CTS** is high, the module is busy and the host UART should not send any further data.

Internally, the module has a 192 byte buffer for incoming characters from the host UART. The module can be programmed to automatically transmit when the buffer reaches a programmed limit, set by **regUARTMTU**. The module can also be programmed to transmit based on a delay between characters, set by **regTXTO** (set in 1mSec increments). These registers allow the designer to optimize performance of the module for fixed length and variable length data. The module will support streaming data, as well. To optimize the module for streaming data, **regUARTMTU** should be set to 144, and **regTXTO** should be set to a value greater than 1 byte time at the current UART data rate. If the buffer gets full, or the timer set by **regTXTO** expires, while the module is still in the process of sending the previous packet over the RF link, the module will assert **CTS** high, indicating that the host should not send any more data. Data sent by the host while **CTS** is high will be lost.

When the MAC layer has a packet to send, it will use a **carrier-sense-multiple-access (CSMA)** protocol to determine if another module is already transmitting. If another module is transmitting, the module will receive that data before attempting to transmit its data again. If, during this process, the UART receive buffer gets full, the **CTS** line will go high to prevent the host UART from over-running the receive buffer. The CSMA mechanism introduces a variable delay to the transmission channel. This delay is the sum of a random period and a weighted period that is dependent on the number of times that the module has tried and failed to acquire the channel. For applications that guarantee that only one module will be transmitting at any given time, the CSMA mechanism can be turned off to avoid this delay.

The MAC layer prefixes the data with a packet header and postfixes the data with a 16-bit CRC. The 16-bit CRC error checking can be disabled to allow the application to do its own error checking. Data is encoded using a proprietary algorithm (DirectSPREAD™) to spread the RF energy within the transmission bandwidth.

Modules can operate in groups. Each module can be assigned an 8-bit group ID, which is used to logically link it to other modules on the same channel. All modules on a channel will interoperate, regardless of their respective group IDs. In other words, the CSMA mechanism will prevent collisions of modules on the same channel but belonging to different groups.

Modules can also operate in two network modes: Master/Slave and Peer-to-Peer. These modes define a set of communication rules that identifies which modules can talk to any given module. In Master/Slave mode, masters can talk to slaves and other masters, slaves can talk to masters, but slaves cannot talk to other slaves. This mode is sometimes required for applications that are replacing legacy RS-485 networks. In peer-to-peer mode, any module can hear any other module. In both modes, group integrity is enforced.

When a module transmits a packet, all other modules on the same channel will receive the packet, check the packet for errors, and determine whether the received group ID matches the local group ID. If the packet is error free and the group IDs match, the module will decrypt the data if necessary, and send the error free data to its host UART for processing. The modules only implement the ISO reference network stack up to the MAC layer, so they are transparent to link layer addressing schemes. Therefore, the modules can work with any link-layer and higher protocols in existence today.

Certain features of the module are controlled through programmable registers. Registers are accessed by bringing **CMD** low. When **CMD** is low, all data transfers from the host UART are considered to be register access commands. When **CMD** is high, all data transfers from the host UART are considered to be raw data that needs to be transparently transmitted across the wireless link. The module maintains two copies of each register: one in flash and one in RAM. On reset, the module loads the RAM registers from the values in the flash registers. The module is operated out of the RAM registers. Applications that need to change parameters of the module often would simply modify the RAM registers. Putting default settings in the flash registers ensures the module always comes up in a preconfigured state, which is useful for applications that do not have external microcontrollers, such as RS-232 adapters.

The UART interface is capable of operating in full duplex at baud rates from 2.4 to 115.2 kbps.

The module has ten power modes: High LP, Mid-High LP, Mid-Low LP, Low DTS, High DTS, Mid-High DTS, Mid-Low DTS, Low LP, Standby, and Sleep.

The Wi.232DTS™ module is the first module in the world to take advantage of the DTS digital spread spectrum provision in FCC part 15 rules. Under this provision, transmitters can operate at a higher output power if the transmission bandwidth is at least 500 KHz. Through an encoding technique we call DirectSPREAD™, the outgoing RF data is encoded with symbols selected to ensure its average duty cycle is 50%. This allows the Wi.232DTS™ module to be able to operate at +11 dBm and meet the requirements of this provision.

In DTS mode, the module's channel bandwidth is set to 600 KHz and the transmit power is set to one of four selectable levels. In this mode, the module can operate on 32 channels and support a maximum effective RF data rate of 100kbps. The receiver sensitivity at the max data rate is -100 dBm typical, yielding a link budget of 111 dB. This mode is an excellent alternative to Frequency Hopping Spread Spectrum. It has no synchronization requirements, allowing it to operate in a duty-cycle mode for extended battery life.

In low-power (LP) mode, the module's channel bandwidth is set to 200 KHz and the transmit power is set to one of four selectable levels. In this mode, the module can operate on 84 channels and support a maximum data rate of 19.2 kbps. The receiver sensitivity at the maximum data rate is -105 dBm typical, yielding a link budget of 102 dB. This mode reduces transmit current consumption, allowing use with batteries that cannot supply the pulse currents required for DTS mode. The range in this mode will be a little more than half of the range in DTS mode. Power settings other than low are available in LP mode, but should only be used when the antenna circuit is lossy.

The module can be put into sleep mode through serial commands. In sleep mode, the RF section is completely shutdown, and the protocol processor is in an idle state. Once the module has been placed in the sleep mode, it can be awakened by either cycling power, which will loose all volatile settings, or by sending a power-up sequence through the serial port, which retains all volatile settings.

**Note:** *When in sleep mode, the module will not be able to receive data from other modules. Any data sent to the module while it is in sleep mode will be lost.*

If the current draw in sleep mode is too high for a particular application, the designer can switch power to the module through a FET to “turn-off” the module when it is not needed. If this technique is used, the volatile registers will reset to the values in their non-volatile mirrors, so any changes from the default will have to be reloaded.

The Wi.232DTS™ is a very flexible module because of all of the configurable parameters it supports. However, modules that are not configured in the same way will not be able to communicate reliably, causing poor performance or outright failure of the wireless link. **All modules in a network must have the same mode configuration to ensure interoperability.**

Every Wi.232 module has read-only internal registers that contain factory programmed information that includes calibration data and a 48-bit MAC address that can be used by the host application for higher level, connection oriented protocols. This MAC address can be read through the command interface.

## 2.2. Operating States

The primary active state is the IDLE state. When the module is not actively transmitting or receiving data, it is in this state. While in this state, the receiver is enabled and the module is continuously listening for incoming data. If the module detects a pre-amble and valid start-code, it will enter the RX\_HEADER state.

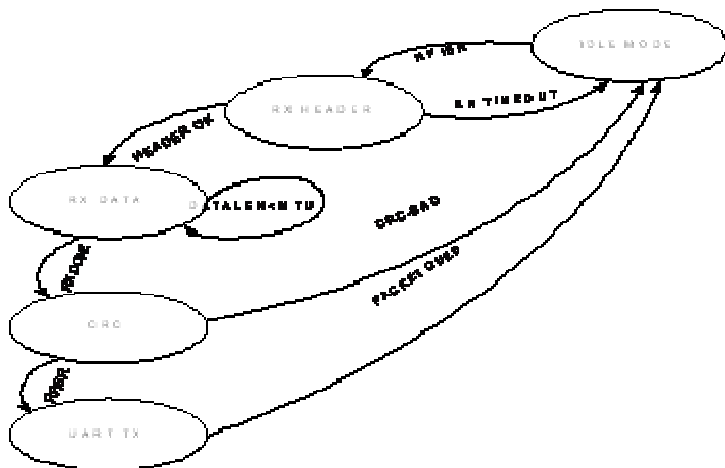

**Figure 4: Rx State Machine**

If the module is in the IDLE state and a byte is received by the UART, it will enter the TX\_WAIT state.

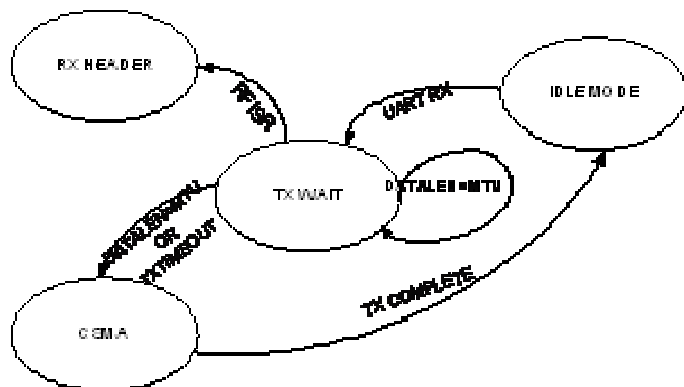

**Figure 5: Tx State Machine**

### 2.3. Resetting Module to Factory Defaults

It may be necessary to reset the non-volatile registers to their factory defaults. To reset the module to factory defaults, hold the command line low and cycle power to or hardware-reset the module. The command line must remain low for a minimum of 450ms after resetting the module. Once the command line is released, the module’s non-volatile registers will be reset to factory defaults.

### 2.4. Hardware Reset

By pulling C2CK/RST (pin 11) low, you will place the module’s protocol controller in hardware reset. In this state, the module is in a safe, stalled state. If your Vdd rise time is greater than 1ms, it will be necessary to hold the module in reset until Vdd reaches 2.7V. There are many reset supervisor ICs that can accomplish this task, such as the Microchip MCP130. See the section on [Rise Time](#) for more information.

In order to cause the module to enter reset, C2CK/RST must be held low for at least 20µs. Normal operation is restored when this pin is returned high.

### 3. Application Information

#### 3.1. Pin-out Diagram

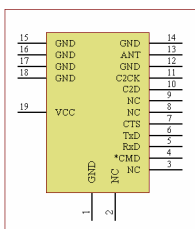

**Figure 6: Pin-out Diagram**

#### 3.2. Pin Description

No.	Description
1	Ground
2	No connect – reserved
3	No connect – reserved
4	Command input – active low
5	UART receive input
6	UART transmit output
7	UART clear to send output – active low
8	No connect – reserved
9	No connect – reserved
10	Reserved – ISP pin C2D
11	ISP pin C2CK / RST
12	Ground
13	Antenna port – 50 ohm
14	Ground
15	Ground
16	Ground
17	Ground
18	Ground
19	VDD – 2.7 to 3.6 VDC

**Table 1, Module Pin Descriptions**

Legend

	Signals that are used in this implementation
	Signals not used in this implementation –do not connect
	Signals used for in-system programming

### 3.3. Mechanical Drawings

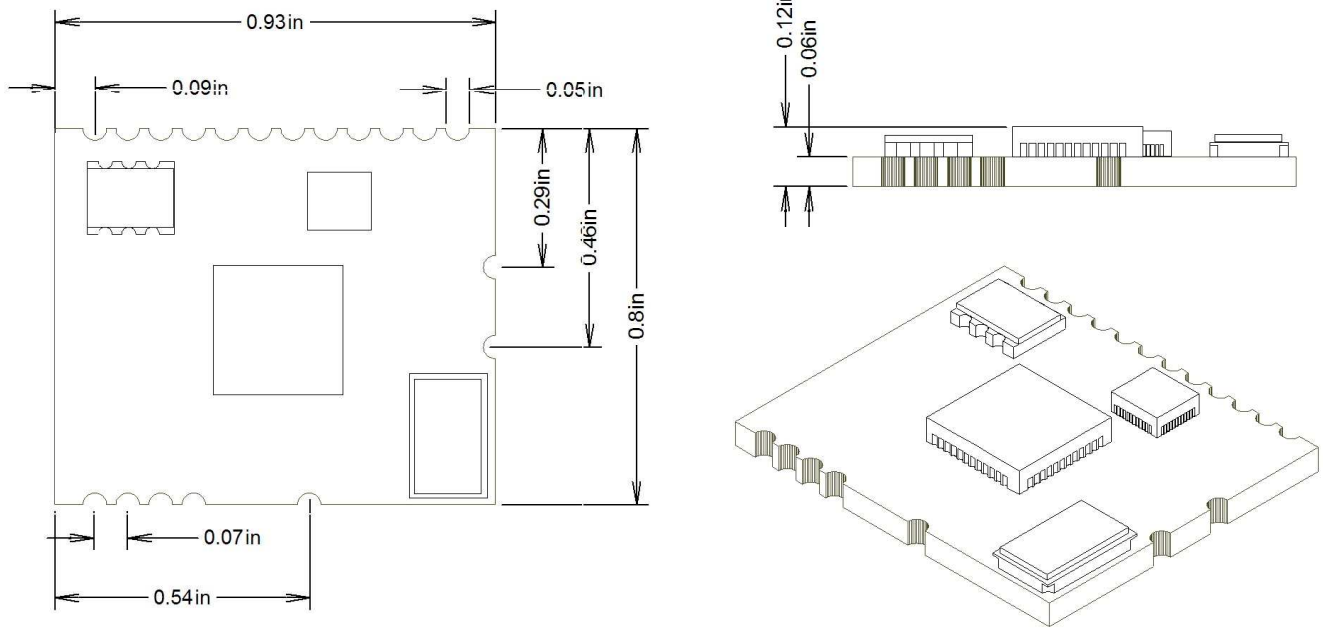

**Figure 7: Module Mechanical Drawings**

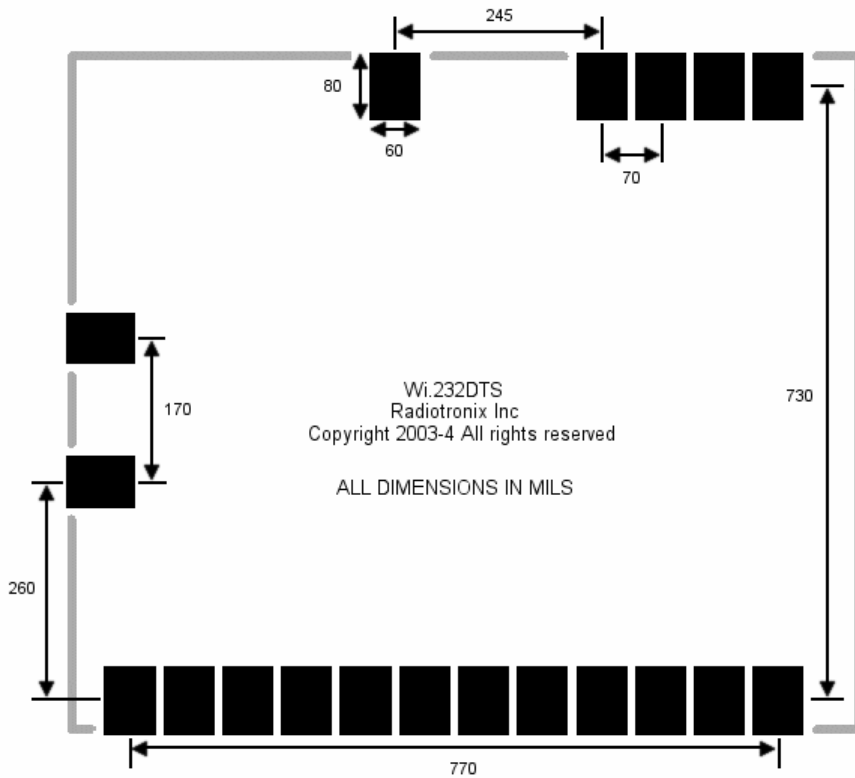

**Figure 8: Wi.232DTS Suggested Footprint**

### 3.4. Example Circuit

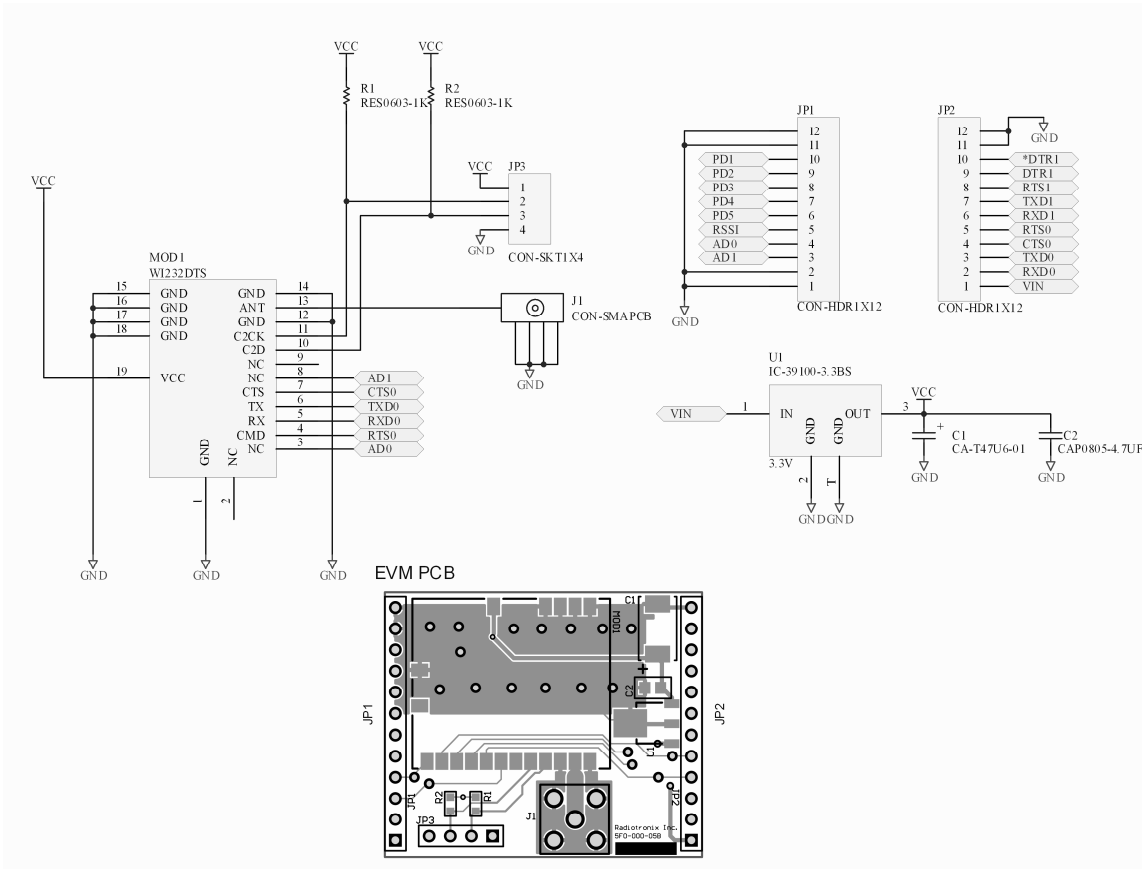

Figure 9: Evaluation Module Circuit

### 3.5. Power Supply

#### 3.5.1. General

Although the Wi.232DTS™ module is very easy to use, care must be given to the design of the power supply circuit. It is important for the power supply to be free of digital noise generated by other parts of the application circuit, such as the RS-232 converter.

Figure 9 shows the schematic for our evaluation module circuit for the Wi.232DTS™ module. It includes an on-board power supply and antenna connector. This evaluation circuit was used to measure the performance of the Wi.232DTS™ module, and should be used as a reference for Wi.232DTS™ based designs. If noise is a problem, it can usually be eliminated by using a dedicated LDO regulator for the module and/or by separating the module grounds and those of the other circuits.

#### 3.5.2. Rise Time

Additionally, power supply rise time is extremely important. The power supply presented to the module must rise from Vss to 2.7V in less than 1ms. If this specification cannot be met, an external reset



supervisor circuit must be used to hold the module in reset until the power supply stabilizes. **Failure to ensure adequate power supply rise time can result in loss of important module configuration information.** See the section on [Hardware Reset](#) for more information.

### 3.6. UART Interface

The UART interface is very simple; it is comprised of four CMOS compatible digital lines.

LINE	DIRECTION	DESCRIPTION
CTS	Out	Clear to send – this pin indicates to the host micro when it is ok to send data. When CTS is high, the host micro should stop sending data to the module until CTS returns to the low state.
CMD	In	Command – the host micro will bring this pin low to put the module in command mode. Command mode is used to set and read the internal registers that control the operation of the module. When CMD is high, the module will transparently transfer data to and from other modules on the same channel.  <b>Note:</b> If this pin is low when the module comes out of reset, the non-volatile registers will be reset to their factory programmed defaults. It is important to ensure that CMD is held high or left floating during power-up under normal conditions.
RxD	In	Receive data input.
TxD	Out	Transmit data output.

**Table 2, Wi.232DTS UART Interface Lines**

### 3.7. Antenna

The module is designed to work with any 900MHz 50-ohm antenna, including PCB trace antennas.

Antenna selection is usually governed by application requirements. In general, external antennas perform better. Radiotronics has a line of antennas and connectors that are compatible with the Wi.232DTS™ modules. Information on these products is available on our website at <http://www.radiotronics.com/antennas>.

As a rule, a ¼ wave whip or ½ wave dipole antenna with a good, solid ground plane (well-coupled, 3.5" x 3.5" or larger is optimal) is the best choice. Dipoles yield better performance than monopoles (whip) when the ground plane is smaller than optimal. However, many embedded applications cannot support an externally mounted antenna. If this is the case, a PCB antenna must be used. The designer can either use an off-of-the-shelf PCB antenna, such as the Fractus FR05-S1-R-0-105, or design a trace antenna. There are several good antenna tutorials and references on the Internet and we encourage the designer to use these resources.

**Note:** Antenna design is difficult and can be impossible without the proper test equipment. As such, we strongly encourage all of our customers to use off-of-the-shelf antennas whenever possible.

### 3.8. Link Budget, Transmit Power, and Range Performance

A link budget is the best figure of merit for comparing wireless solutions and determining how they will perform in the field.

In general, the solution with the best link budget will deliver the best line-of-sight range performance. Improving the link budget by increasing the receiver sensitivity will result in lower power consumption, while improving the link budget by increasing the transmit power will result in a more robust performance in the presence of an on-channel interferer or multi-path interference.

The transmit power on unlicensed devices is regulated by the FCC. For transmitters that are not spread-spectrum, the output power is limited to 0 dBm (1mW) when a standard ¼ wave whip antenna is used. If the transmitter operates under the spread-spectrum rules, however, the transmit power can be increased; up to 1W depending on the spread-spectrum technique and antennas that are used.

**Wireless Fact:** *Frequency Hopping Spread Spectrum combats in-channel interference, but at the expense of bandwidth, power consumption, and latency. Direct Sequence Spread Spectrum does a better job than FHSS at combating in-channel interference, but at the expense of occupied bandwidth and power consumption. These spread spectrum techniques are generally chosen because the FCC will allow higher output power from a transmitter employing these techniques. Recently, the FCC rules changed to include a new type of spread spectrum device, called Digital Transmission System (DTS). This method of spread spectrum has no processing gain, but allows lower cost solutions like the Wi.232DTS™ to transmit with higher output power.*

To calculate the link budget for a wireless link, simply add the transmit power, the antenna gains, and the receiver sensitivity:

$$LB = Ptx + Gtxa - SENSrx + Grxa$$

For example, the link budget for a pair of Wi.232 modules in DTS mode at the maximum data rate and using 3dBi whips antennas would be:

$$+11dBm + 3dB - (-100dBm) + 3dB = 117dB$$

A link budget of 117dB should easily yield a range of ¼ mile or more outdoors. If the environment is open and the antennas are 8 to 10 feet off of the ground, the range could be a mile. Indoors, this link budget should yield a range of several hundred feet.

This is a well-balanced link budget. More than 10dB of the budget is achieved through transmit power, which will allow good performance indoors in the presence of multi-path while keeping the overall operating current low, making the module suitable for primary battery powered applications such as RFID and automated meter reading.

## 4. Module Configuration

### 4.1. Channel Settings

regNVTXCHAN (0x00)			regTXCHAN (0x4B)				
R/W	R/W	R/W	R/W	R/W	R/W	R/W	R/W
RES	D6	D5	D4	D3	D2	D1	D0
7	6	5	4	3	2	1	0

regNVRXCHAN (0x01)			regRXCHAN (0x4C)				
R/W	R/W	R/W	R/W	R/W	R/W	R/W	R/W
RES	D6	D5	D4	D3	D2	D1	D0
7	6	5	4	3	2	1	0

The North American and Brazilian versions of the Wi.232DTS™ supports 32 channels (0 – 31) in DTS mode and 83 channels (1 – 83) in low power mode. LP channel 0 is not available in the FCC pre-certified and all Anatel versions of the module; a value of zero in the channel register will select channel 1.

For Brazilian versions, DTS channels 12-17 are aliased to channel 18 and DTS channels 5 – 11 are aliased to channel 4. Similarly, LP channels 14 – 29 are aliased to channel 13 and LP channels 30 – 44 are aliased to channel 45. This is due to the frequency restrictions placed on the 907 to 915MHz sub-band in Brazil, and limits the number of *unique* channels to 19 DTS and 51 LP. All non-aliased channels are compatible with their North American counterparts.

Transmit and receive channels are set in **regTXCHAN (addr 0x4B)** and **regRXCHAN (addr 0x4C)** respectively. **PLEASE NOTE:** If you set the module to have different transmit and receive channels, it will render the CSMA algorithm ineffective.

When the module is in DTS mode, the channel registers are masked so that only the lower 6-bits determine the channel.

The following equations can be used to calculate transmit center frequency in LP and DTS modes, remembering the exceptions listed above for the Anatel versions.

$$F_c = 902.271 + chan * .3007MHz(LP)$$

$$F_c = 902.972 + chan * .7517MHz(DTS)$$

All modules in a network must be in the same mode (LP or DTS) and must have the same transmit and receive channels programmed in order to communicate properly.

## 4.2. Power Mode

The transmission and reception modes of the module are determined by the settings of the **regPWRMODE** register. It is important to note that a module configured to operate in LP mode cannot “hear” another module transmitting in DTS mode, or vice versa. However, a module configured to operate in any of the three DTS modes can “hear” any other module transmitting in any of the DTS modes (provided that they are within range of one another). LP mode operation must be low power. Additional power settings are included for cases where the antenna circuit is very lossy, such as a PCB loop antenna.

regNVPWRMODE (0x02)					regPWRMODE (0x4D)		
R/W	R/W	R/W	R/W	R/W	R/W	R/W	R/W
NA	NA	NA	NA	NA	PM2	PM1	PM0
7	6	5	4	3	2	1	0

PM2	PM1	PM0	POWER MODE (typical)
0	0	0	LP Mode: low power setting
0	0	1	DTS Mode: mid-low power setting
0	1	0	DTS Mode: mid-high power setting
0	1	1	DTS Mode: high power setting
1	0	0	DTS Mode, low power setting
1	0	1	LP Mode: mid-low power setting
1	1	0	LP Mode: mid-high power setting
1	1	1	LP Mode: high power setting

**Table 3, Power Mode Register Settings**

### 4.2.1. DTS Mode

DTS Mode Parameters	
Tx Power	-4, +1, +6, or +11 dBm
Deviation	+/- 235 kHz
Tx Current	26 to 72 mA
Rx Current	16 to 24 mA
Rx Bandwidth	600 kHz

**Table 4, DTS Mode Parameters**

### 4.2.2. Low Power (LP) Mode

In low-power mode, the module is configured as follows:

Low Power Mode Parameters	
Tx Power	-4 dBm (+1, +6, and +11 dBm available)
Deviation	+/- 75 kHz
Tx Current	26 to 72 mA
Rx Current	16 to 24 mA
Rx Bandwidth	200 kHz

**Table 5, Low Power Mode Parameters**

### 4.3. UART Data Rate

regNVDATARATE (0x03)			regDATARATE (0x4E)				
R/W	R/W	R/W	R/W	R/W	R/W	R/W	R/W
RES	RES	RES	RES	RES	BR2	BR1	BR0
7	6	5	4	3	2	1	0

By default, the UART data rate is set to 2.4 kbps at the factory. This data rate can be changed by setting the **regDATARATE** register. Valid settings are:

Baud Rate	BR2	BR1	BR0
2400	0	0	0
9600	0	0	1
19200	0	1	0
38400	0	1	1
57600	1	0	0
115200	1	0	1
10400*	1	1	0
31250*	1	1	1

\* These data rates are not supported by PC serial ports. Selection of these rates may cause the module to fail to respond to a PC, requiring a reset to factory defaults.

**Table 6, Data Rate Register Settings**

**TROUBLESHOOTING HINT: Baud Rate Problems.** *If you lose track of the baud rate setting of the module, it will be impossible to program the module. You can either try every possible baud rate to discover the setting, or force a power-on reset with CMD held low to set the baud rate to its default: 2.4kbit/second.*

### 4.4. Network Mode

regNVNETMODE (0x04)			regNETMODE (0x4F)				
R/W	R/W	R/W	R/W	R/W	R/W	R/W	R/W
D7	D6	D5	D4	D3	D2	D1	D0
7	6	5	4	3	2	1	0

The module supports two networking modes: Normal and Slave. In normal mode, the module can talk to any other module. In slave mode, the module can talk to normal-mode modules, but cannot transmit to or receive from other slaves. Slave mode is selected by writing 0x00 to this register. The default network mode is 0x01 or 0x80 (Normal Mode).

## 4.5. Transmit Wait Timeout

regNVTXTO (0x05)					regTXTO (0x50)		
R/W	R/W	R/W	R/W	R/W	R/W	R/W	R/W
D7	D6	D5	D4	D3	D2	D1	D0
7	6	5	4	3	2	1	0

When a byte is received from the UART, the module will start a timer that will countdown every millisecond. The timer is restarted when each byte is received.

If the timer reaches zero before the next byte is received from the UART, the module begin transmitting the data in the buffer. Normally, this timeout value should be greater than 0x01 and greater than one byte time at the current UART data rate. If the timeout value is set to 0x00, the transmit wait timeout will not operate, and a full buffer will be required for transmission. When setup this way, the data will be sent only when a full MTU has been received through the UART. The default setting for this register is 0x10 (~16ms delay).

## 4.6. Network Group

regNVNETGRP (0x06)					regNETGRP (0x51)		
R/W	R/W	R/W	R/W	R/W	R/W	R/W	R/W
B7	B6	B5	B4	B3	B2	B1	B0
7	6	5	4	3	2	1	0

Modules can be grouped into networks. Although only modules with the group ID will be able to talk to each other, modules in different groups but on the same channel will still coordinate transmissions through the CSMA mechanism. Valid values for this register are 0 to 127. The default group setting is 0.

## 4.7. CRC Control

regNVUSECRC (0x08)					regUSECRC (0x53)		
R/W	R/W	R/W	R/W	R/W	R/W	R/W	R/W
B7	B6	B5	B4	B3	B2	B1	B0
7	6	5	4	3	2	1	0

Set to 0x01 to enable receive CRC checking, or 0x00 to disable it. The default CRC mode setting is enabled.

## 4.8. UART Minimum Transmission Unit

regNVUARTMTU (0x09)					regUARTMTU (0x54)		
R/W	R/W	R/W	R/W	R/W	R/W	R/W	R/W
B7	B6	B5	B4	B3	B2	B1	B0
7	6	5	4	3	2	1	0

This register determines the UART buffer level that will trigger the transmission of a packet. The minimum value is 1 and the maximum value is 144. The default value for this register is 64, which provides a good mix of throughput and latency.

## 4.9. Verbose Mode

regNVSHOWVER (0x0A)					regSHOWVER (0x55)*		
R/W	R/W	R/W	R/W	R/W	R/W	R/W	R/W
B7	B6	B5	B4	B3	B2	B1	B0
7	6	5	4	3	2	1	0

Setting this register to 0x00 will suppress the start-up message, including firmware version, which is sent to the UART when the module is reset. A value of 0x01 will cause the message to be displayed after reset. By default, the module start-up message will be displayed. \*The volatile register counterpart (0x55) has no function.

## 4.10. CSMA Enable

regNVCSMAMODE (0x0B)					regCSMAMODE (0x56)		
R/W	R/W	R/W	R/W	R/W	R/W	R/W	R/W
B7	B6	B5	B4	B3	B2	B1	B0
7	6	5	4	3	2	1	0

Carrier-sense multiple access (CSMA) is a best-effort delivery system that listens to the channel before transmitting a message. If another Wi.232 module is already transmitting when a message is queued, the module will wait before sending its payload. This helps to eliminate RF message corruption at the expense of additional latency. Setting this register to 0x01 will enable CSMA. Setting this register to 0x00 will disable CSMA. By default, CSMA is enabled.

## 4.11. Sleep Control

regNVSLPMODE (0x0D)					regSLPMODE (0x58)		
R/W	R/W	R/W	R/W	R/W	R/W	R/W	R/W
B7	B6	B5	B4	B3	B2	B1	B0
7	6	5	4	3	2	1	0

Setting this register to 0x01 will place the module into sleep mode; 0x02 will place the module in Standby mode. Sleep mode places the module in the lowest power inactive state and requires approximately 7-8ms to resume transmission or reception once awakened. Standby draws ~850 $\mu$ A and requires approximately 1-2ms to awaken. To wake up the module, data should be sent to the module's UART. Use a sequence 0x0F, 0xFF, 0xFF. Upon awakening, the module will clear the volatile register to 0x00. The default value for this register is 0x00 (awake).

By default, the module will send an acknowledgement character (0x06) to the UART Tx pin to let the calling application know that it is awake and ready. To control this feature, see "ACK on Wake" in this section.

## 4.12. ACK on Wake

regNVACKONWAKE (0x0E)					regACKONWAKE (0x59)		
R/W	R/W	R/W	R/W	R/W	R/W	R/W	R/W
B7	B6	B5	B4	B3	B2	B1	B0
7	6	5	4	3	2	1	0

When the module's RF components are ready to transmit/receive, the module can send an ACK character (0x06) to the host through the UART TxD pin. This notification let the host processor know when the module is ready to commence RF communications. Set this register to 0x00 to prevent the sending of this character, or 0x01 to allow the character to be sent. The default value for this register is 0x01.

## 4.13. MAC Address

regMAC5- regMAC0 (0x22-0x27)					N/A		
R	R	R	R	R	R	R	R
D7	D6	D5	D4	D3	D2	D1	D0
7	6	5	4	3	2	1	0

These registers make a unique 48-bit MAC address. These values are factory preset and cannot be altered. These address bytes are not used by the module. They are provided for customer applications as a unique address.

## 4.14. Release Number

regRELEASENUM (0x78)					N/A		
R	R	R	R	R	R	R	R
D7	D6	D5	D4	D3	D2	D1	D0
7	6	5	4	3	2	1	0

This register indicates the firmware release number for the module. The following table translates Wi.232DTS™ release numbers to firmware versions.

Release Number	Module Type	Version Number
0	DTS	1.1.0
1	EUR	1.2.6
2	DTS	1.2.6
3	EUR	1.3.1 (current)
4	DTS	1.3.0 (current)
5	DTS-FCC	1.3.0 (current)
8	DTS-FCC	1.3.0 (current)
18	DTSB	1.3.0 (current)

**Table 7, Release Number to Version Number**



## 4.15. Register Summary

Volatile Read/ Write Registers		
Name	Address	Description
regTXCHANNEL	0x4B	Transmit channel setting
regRXCHANNEL	0x4C	Receive channel setting
regPWRMODE	0x4D	Operating mode settings
regDATARATE	0x4E	UART data rate
regNETMODE	0x4F	Network mode (normal or slave)
regTXTO	0x50	Transmit wait timeout
regNETGRP	0x51	Network group ID
regUSECRC	0x53	Enable/ Disable CRC
regUARTMTU	0x54	Minimum transmission unit
regSHOWVER	0x55	Enable/ Disable start-up message
regCSMAMODE	0x56	Enable/ Disable CSMA
regSLPMODE	0x58	Power state of module
regACKONWAKE	0x59	Send ACK character to host on wake

Non-Volatile Read-Only Registers		
Name	Address	Description
regMAC5	0x22	These registers form the unique 48-bit MAC address
regMAC4	0x23	
regMAC3	0x24	
regMAC2	0x25	
regMAC1	0x26	
regMAC0	0x27	
regRELEASENUM	0x78	Firmware release number

Non-Volatile Registers			
Name	Address	Description	Default
regNVTXCHANNEL	0x00	Transmit channel setting	16
regNVRXCHANNEL	0x01	Receive channel setting	16
regNVPWRMODE	0x02	Operating mode settings	+11 dBm DTS mode
regNVDATARATE	0x03	UART data rate	2400 bps
regNVNETMODE	0x04	Network mode (normal or slave)	Normal
regNVTXTO	0x05	Transmit wait timeout	~16 ms
regNVNETGRP	0x06	Network group ID	0x00
regNVUSECRC	0x08	Enable/ Disable CRC	Enabled
regNVUARTMTU	0x09	Minimum transmission unit	64 bytes
regNVSHOWVER	0x0A	Enable/ Disable start-up message	Enabled
regNVCSMAMODE	0x0B	Enable/ Disable CSMA	Enabled
regNVSLPMODE	0x0D	Power state of module	Awake
regNVACKONWAKE	0x0E	Send ACK character to host on wake	Yes

**Table 8, Register Summary**

## 5. Using Configuration Registers

### 5.1. CMD Pin

The CMD pin is used to inform the module where incoming UART information should be routed. When the CMD pin is high or left floating, all incoming UART information is treated as payload data and transferred over the wireless interface. If the CMD pin is low, the incoming UART data is routed to the command parser for processing. Since the module's processor looks at UART data one byte at a time, the CMD line must be held low for the entire duration of the command plus a 20 $\mu$ s margin for processing. Leaving the CMD pin low for additional time (for example, until the ACK byte is received by your application) will not adversely affect the module. If RF packets are received while the CMD line is active, they are still processed and presented to the module's UART for transmission.

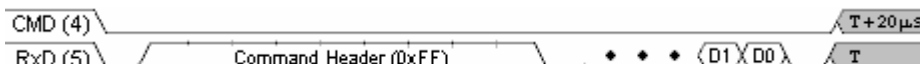

**Figure 10: Command and CMD Pin Timing**

### 5.2. Command Formatting

The Wi.232DTS™ module contains several volatile and non-volatile registers that control its configuration and operation. The volatile registers all have a non-volatile mirror registers that are used to determine the default configuration when power is applied to the module. During normal operation, the volatile registers are used to control the module.

Placing the module in the command mode allows these registers to be programmed. Byte values in excess of 127 (0x80 or greater) must be changed into a two-byte escape sequence of the format: 0xFE, [value - 128]. For example, the value 0x83 becomes 0xFE, 0x03. The following function will prepend a 0xFF header and size specifier to a command sequence and create escape sequences as needed. It is assumed that **\*src** is populated with either the register number to read (one byte, pass 1 into **src\_len**) or the register number and value to write (two bytes, pass 2 into **src\_len**). It is also assumed that the **\*dest** buffer has enough space for the two header characters plus, the encoded command, and the null terminator.

```

int EscapeString(char *src, char src_len, char *dest)
{
    // The following function copies and encodes the first
    // src_len characters from *src into *dest. This
    // encoding is necessary for Wi.232 command formats.
    // The resulting string is null terminated. The size
    // of this string is the function return value.
    // -----
    char src_idx, dest_idx;

    // Save space for the command header and size bytes
    // -----
    dest_idx = 2;

    // Loop through source string and copy/encode
    // -----
    for (src_idx = 0; src_idx < src_len; src_idx++)
    {
        if (src[src_idx] > 127)
        {
            dest[dest_idx++] = 0xFE;
        }/*if*/

        dest[dest_idx++] = (src[src_idx] & 0x7F);
    }/*for*/

    // Add null terminator
    // -----
    dest[dest_idx] = 0;

    // Add command header
    // -----
    dest[0] = 0xFF;
    dest[1] = dest_idx - 2;

    // Return escape string size
    // -----
    return dest_idx;
}

```

**Figure 11: Command Conversion Code**

### 5.3. Writing to Registers

Writing to a volatile register is nearly instantaneous. Writing to a non-volatile register, however, typically takes 16 ms. Because the packet size can vary based on the need for encoding, there are two possible packet structures. The following tables show the byte sequences for writing a register in each case.

**WARNING:** Be sure that the module is properly powered and remains powered for the duration of the register write. Loss of important configuration information could occur if the unit loses power during a non-volatile write cycle.

Byte 0								Byte 1								Byte 2								Byte 3							
Header								Size								Register								Value							
7	6	5	4	3	2	1	0	7	6	5	4	3	2	1	0	7	6	5	4	3	2	1	0	7	6	5	4	3	2	1	0
0xFF								0x02								0	Register							0	Value						

**Table 9, Write Register Command, value to be written is less than 128 (0x80)**

Byte 0								Byte 1								Byte 2								Byte 3								Byte 4									
Header								Size								Register								Escape								Value									
7	6	5	4	3	2	1	0	7	6	5	4	3	2	1	0	7	6	5	4	3	2	1	0	7	6	5	4	3	2	1	0	7	6	5	4	3	2	1	0		
0xFF								0x03								0	Register								0xFE								0	Lower 7 bits of Value							

**Table 10, Write Register Command, value to be written is greater than or equal to 128 (0x80)**

The module will respond to this command with an ACK (0x06). If an ACK is not received, the command should be resent. If a write is attempted to a read-only or invalid register, the module will respond with a NACK (0x15).

## 5.4. Reading from Registers

A register read command is constructed by placing an escape character before the register number. The following table shows the byte sequence for reading a register.

Byte 0								Byte 1								Byte 2								Byte 3								
Header								Size								Escape								Register								
7	6	5	4	3	2	1	0	7	6	5	4	3	2	1	0	7	6	5	4	3	2	1	0	7	6	5	4	3	2	1	0	
0xFF								0x02								0xFE								0	Register							

**Table 11, Read Register Command**

The module will respond to this command by sending an ACK (0x06) followed by the register number and register value. The register value is sent unmodified. For example, if the register value is 0x83, 0x83 is returned after the ACK (0x06). See table below for the format of the response. If the register number is invalid, it will respond with a NACK (0x15).

Byte 0								Byte 1								Byte 2								
ACK								Register								Value								
7	6	5	4	3	2	1	0	7	6	5	4	3	2	1	0	7	6	5	4	3	2	1	0	
0x06								0	Register								Value							

**Table 12, Read Register Module Response for a Valid Register**

## 6. Electrical Specifications

### 6.1. Absolute Maximum Ratings

Operating the module in conditions that exceed the absolute maximum ratings may cause damage to the device. Operation at these ratings is not implied. Exposure to maximum rating conditions for an extended period of time may adversely affect device reliability.

Parameter	Min	Max	Units
Vdd- Power Supply		3.9	VDC
Voltage on any I/O pin	-0.3	5.3	VDC
Allowed Vdd Rise Time		1	ms
Input RF Level		-1	dBm
Storage Temperature	-40	+85	°C

**Table 13, Absolute Maximum Ratings**

## 6.2. Detailed Electrical Specifications

### 6.2.1. AC Specifications- Rx

Parameter	Min	Typ	Max	Units	Notes
Receive Frequency	902.2		927.8	MHz	At antenna pin
Channels- DTS Mode		32			
Channels- LP Mode		84			
Channel Spacing- DTS Mode		750		kHz	
Channel Spacing- LP Mode		300		kHz	
Receiver Sensitivity- DTS Mode		-100		dBm	152.34 kbit/ sec RF
Receiver Sensitivity- DTS Mode		-102		dBm	38.4 kbit/ sec RF
Receiver Sensitivity- DTS Mode		-104		dBm	9.6 kbit/ sec RF
Receiver Sensitivity- LP Mode		-104		dBm	38.4 kbit/ sec RF
Receiver Sensitivity- LP Mode		-105		dBm	9.6 kbit/ sec RF
Input IP3		-40		dBm	F <sub>LO</sub> +1 MHz & F <sub>LO</sub> +1.945 MHz
Input Impedance		50		Ohms	No matching required
LO Leakage		-65		dBm	50 Ohm termination at ANT
Adjacent Channel Rejection		-48		dBc	F <sub>c</sub> +/- 650 kHz
IF Bandwidth- DTS Mode		600		kHz	
IF Bandwidth- LP Mode		200		kHz	

**Table 14, AC Specifications- Rx**

### 6.2.2. AC Specifications- Tx

Parameter	Min	Typ	Max	Units	Notes
Transmit Frequency	902.2		927.8	MHz	
Maximum Effective RF Data Rate		100		kbps	Encoding/overhead losses included, 144 byte MTU
Center Frequency Error		2	5	ppm	915 MHz @ 25°C
Frequency Deviation- DTS Mode		235		kHz	
Frequency Deviation- LP Mode		75		kHz	
Low Output Power, Conducted		-4	-1	dBm	915 MHz into 50 Ohm load
Mid-Low Output Power, Conducted		1	4	dBm	915 MHz into 50 Ohm load
Mid-High Output Power, Conducted		6	9	dBm	915 MHz into 50 Ohm load
High Output Power, Conducted		11	14	dBm	915 MHz into 50 Ohm load
Output Impedance		50		Ohms	
Carrier Phase Noise		TBD		dBc	Into 50 Ohm load
Harmonic Output		-50		dBc	Into 50 Ohm load

**Table 15, AC Specifications- Tx**

### 6.2.3. DC Specifications

Parameter	Min	Typ	Max	Units	Notes
Operating Temperature	-40		+85	°C	HW Revision C and later
Supply Voltage	2.7	3.3	3.6	VDC	
Receive Current Consumption		16 – 24		mA	Continuous operation, Vdd= 3.3 VDC, varies with UART data rate selected
Transmit Current Consumption					
Low Power		26 – 35		mA	Output into 50 Ohm load, Vdd= 3.3 VDC, varies with UART data rate selected
Mid-Low Power		33 – 44		mA	
Mid-High Power		48 – 56		mA	
High Power		63 – 72		mA	
Standby Current Consumption		850		µA	Vdd= 3.3 VDC
Sleep Current Consumption		35		µA	Vdd= 3.3 VDC
Vih- Logic High Level Input	0.7*Vdd		5.0	VDC	
Vil- Logic Low Level Input	0		0.3*Vdd	VDC	
Voh- Logic High Level Output	2.5		Vdd	VDC	
Vol- Logic Low Level Output	0		0.4	VDC	

**Table 16, DC Specifications**

### 6.2.4. Flash Specifications (Non-Volatile Registers)

Parameter	Min	Typ	Max	Units	Notes
Flash Write Duration		16	21	ms	Module stalled during operation
Flash Write Cycles	20k	100k		cycles	

**Table 17, Flash Specifications (Non-Volatile Registers)**

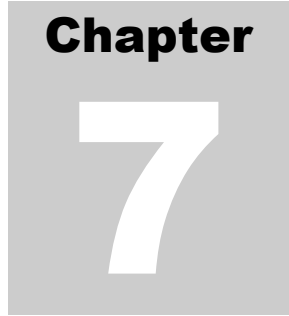

## **7. Custom Applications**

For cost-sensitive applications, such as wireless sensors and AMR, Radiotronix can embed the application software directly into the microcontroller built into the module. For more information on this service, please contact Radiotronix.



## 8. Ordering Information

Product Part Number	Description
Wi.232DTS-R	North American Wi.232DTS-R Embedded Wireless Module (902-928 MHz)
Wi.232DTSB-R	Brazilian Wi.232DTS-R Embedded Wireless Module (902-907, 915-928 MHz)
Wi.232EUR	European Union Wi.232EUR-R (DTS variant) Embedded Wireless Module (868-870 MHz)
RK-Wi.232DTS-FCC-R	North American Wi.232DTS-R Development Kit
RK-Wi.232DTSB-R	Brazilian Wi.232DTS-R Development Kit
RK-Wi.232EUR-R	European Union Wi.232EUR Development Kit

## 9. Contact Information

Corporate Headquarters:  
 905 Messenger Lane  
 Moore, Oklahoma 73160  
 405-794-7730  
 website: [www.radiotronix.com](http://www.radiotronix.com)  
 support: <http://www.radiotronix.com/support>

### 9.1. Technical Support

Radiotronix has built a solid technical support infrastructure so that you can get answers to your questions when you need them. Our primary technical support tools are the support forum and knowledge base found on our website. We are continuously updating these tools. To find the latest information about these technical support tools, please visit <http://www.radiotronix.com/support>. Our technical support engineers are available Mon-Fri between 9:00 am and 5:00 pm central standard time. The best way to reach a technical support engineer is to submit a Webcase. Webcase submissions can be made at <http://www.radiotronix.com/support/webcase.asp>. For customers that would prefer to talk directly to a support engineer, we do offer phone support free of charge.

### 9.2. Sales Support

Our sales department can be reached via e-mail at [sales@radiotronix.com](mailto:sales@radiotronix.com) or by phone at 405-794-7730. Our sales department is available Mon-Fri between 8:30 am and 5:00 pm central standard time. Visit our web site at <http://www.radiotronix.com/corpsales.asp> for information on where to buy our products.