



16-BIT, QUAD VOLTAGE OUTPUT DIGITAL-TO-ANALOG CONVERTER

FEATURES

- **Low Power: 10 mW**
- **Unipolar or Bipolar Operation**
- **Settling Time: 10 μ s to 0.003%**
- **15-Bit Linearity and Monotonicity: -40°C to 85°C**
- **Programmable Reset to Mid-Scale or Zero-Scale**
- **Double-Buffered Data Inputs**

APPLICATIONS

- **Process Control**
- **Closed-Loop Servo-Control**
- **Motor Control**
- **Data Acquisition Systems**
- **DAC-Per-Pin Programmers**

DESCRIPTION

The DAC7634 is a 16-bit, quad voltage output, digital-to-analog converter with specified 15-bit monotonic performance over the specified temperature range. It accepts 24-bit serial input data, has double-buffered DAC input logic (allowing simultaneous update of all DACs), and provides a serial data output for daisy-chaining multiple DACs. Programmable asynchronous reset clears all registers to a mid-scale code of 8000_H or to a zero-scale of 0000_H. The DAC7634 can operate from a single 5-V supply or from 5-V and -5 V supplies.

Low power and small size per DAC make the DAC7634 ideal for automatic test equipment, DAC-per-pin programmers, data acquisition systems, and closed-loop servo-control. The DAC7634 is available in a 48-lead SSOP package and offers specifications over the -40°C to 85°C temperature range.

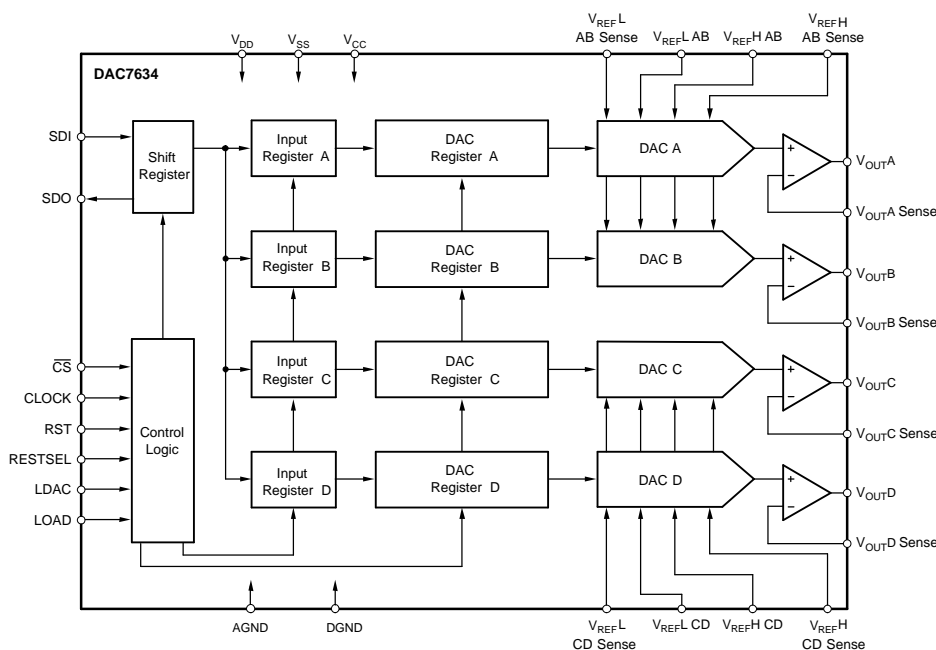

Please be aware that an important notice concerning availability, standard warranty, and use in critical applications of Texas Instruments semiconductor products and disclaimers thereto appears at the end of this data sheet.



This integrated circuit can be damaged by ESD. Texas Instruments recommends that all integrated circuits be handled with appropriate precautions. Failure to observe proper handling and installation procedures can cause damage.

ESD damage can range from subtle performance degradation to complete device failure. Precision integrated circuits may be more susceptible to damage because very small parametric changes could cause the device not to meet its published specifications.

PACKAGE/ORDERING INFORMATION

PRODUCT	LINEARITY ERROR (LSB)	DIFFERENTIAL NONLINEARITY (LSB)	PACKAGE	PACKAGE DRAWING NUMBER	SPECIFICATION TEMPERATURE RANGE	ORDERING NUMBER ⁽¹⁾	TRANSPORT MEDIA
DAC7634E	±4	±3	48-Lead SSOP	333	–40°C to 85°C	DAC7634E	Rails
						DAC7634E/1K	Tape and Reel
DAC7634EB	±3	±2	48-Lead SSOP	333	–40°C to 85°C	DAC7634EB	Rails
						DAC7634E/1K	Tape and Reel

(1) Models with a slash (/) are available only in Tape and Reel in the quantities indicated (e.g., /1K indicates 1000 devices per reel). Ordering 1000 pieces of DAC7634E/1K will get a single 1000-piece Tape and Reel.

ABSOLUTE MAXIMUM RATINGS⁽¹⁾

		UNIT
	V _{CC} and V _{DD} to V _{SS}	–0.3 V to 11 V
	V _{CC} and V _{DD} to GND	–0.3 V to 5.5 V
	V _{REFL} to V _{SS}	–0.3 V to (V _{CC} – V _{SS})
	V _{CC} to V _{REFH}	–0.3 V to (V _{CC} – V _{SS})
	V _{REFH} to V _{REFL}	–0.3 V to (V _{CC} – V _{SS})
	Digital input voltage to GND	–0.3 V to V _{DD} + 0.3 V
	Digital output voltage to GND	–0.3 V to V _{DD} + 0.3 V
T _J	Maximum junction temperature	150°C
T _A	Operating temperature range	–40°C to 85°C
T _{stg}	Storage temperature range	–65°C to 125°C
	Lead temperature (solder, 10s)	300°C

(1) Stresses above those listed under "absolute maximum ratings" may cause permanent damage to the device. Exposure to absolute maximum conditions for extended periods may affect device reliability.

SPECIFICATIONS

At T_A = T_{MIN} to T_{MAX}, V_{DD} = V_{CC} = 5 V, V_{SS} = –5 V, V_{REFH} = 2.5 V, and V_{REFL} = –2.5 V, unless otherwise noted

PARAMETER	TEST CONDITIONS	DAC7634E			DAC7634EB			UNIT
		MIN	TYP	MAX	MIN	TYP	MAX	
ACCURACY								
Linearity error			±3	±4		±2	±3	LSB
Linearity match			±4			±2		LSB
Differential linearity error			±2	±3		±1	±2	LSB
Monotonicity, T _{MIN} to T _{MAX}		14			15			Bits
Bipolar zero error			±1	±2		±1	±2	mV
Bipolar zero error drift			5	10		5	10	ppm/°C
Full-scale error			±1	±2		±1	±2	mV
Full-scale error drift			5	10		5	10	ppm/°C
Bipolar zero matching	Channel-to-channel matching		±1	±2		±1	±2	mV
Full-scale matching	Channel-to-channel matching		±1	±2		±1	±2	mV
Power supply rejection ratio (PSRR)	At full scale		10	100		10	100	ppm/V

SPECIFICATIONS (continued)

 At $T_A = T_{MIN}$ to T_{MAX} , $V_{DD} = V_{CC} = 5\text{ V}$, $V_{SS} = -5\text{ V}$, $V_{REFH} = 2.5\text{ V}$, and $V_{REFL} = -2.5\text{ V}$, unless otherwise noted

PARAMETER	TEST CONDITIONS	DAC7634E			DAC7634EB			UNIT
		MIN	TYP	MAX	MIN	TYP	MAX	
ANALOG INPUT								
Voltage output	$V_{REF} = -2.5\text{ V}$, $R_L = 10\text{ k}\Omega$, $V_{SS} = -5\text{ V}$	V_{REFL}		V_{REFH}	V_{REFL}		V_{REFH}	V
Output current		-1.25		1.25	1.25		1.25	mA
Maximum load capacitance	No oscillation		500		500			pF
Short-circuit current			-10, 30		-10, +30			mA
Short-circuit duration	GND or V_{CC} or V_{SS}		Indefinite		Indefinite			
REFERENCE INPUT								
Ref high input voltage range		$V_{REFL} + 1.25$		2.5	$V_{REFL} + 1.25$		2.5	V
Ref low input voltage range		-2.5		$V_{REFH} - 1.25$	-2.5		$V_{REFH} - 1.25$	V
Ref high input current			500		500			μA
Ref low input current			-500		-500			μA
DYNAMIC PERFORMANCE								
Settling time	To $\pm 0.003\%$, 5-V output step		8	10	8		10	μs
Channel-to-channel crosstalk	See Figure 5		0.5		0.5			LSB
Digital feedthrough			2		2			nV-s
Output noise voltage	$f = 10\text{ kHz}$		60		60			$\text{nV}/\sqrt{\text{Hz}}$
DAC glitch	$7FFF_H$ to 8000_H or 8000_H to $7FFF_H$		40		40			nV-s
DIGITAL INPUT								
V_{IH}		$0.7 \times V_{DD}$			$0.7 \times V_{DD}$			V
V_{IL}		$0.3 \times V_{DD}$			$0.3 \times V_{DD}$			V
I_{IH}			± 10		± 10			μA
I_{IL}			± 10		± 10			μA
DIGITAL OUTPUT								
V_{OH}	$I_{OH} = -0.8\text{ mA}$	3.6	4.5		3.6	4.5		V
V_{OL}	$I_{OL} = 1.6\text{ mA}$		0.3	0.4		0.3	0.4	V
POWER SUPPLY								
V_{DD}		4.75	5.0	5.25	4.75	5.0	5.25	V
V_{CC}		4.75	5.0	5.25	4.75	5.0	5.25	V
V_{SS}		-5.25	-5.0	-4.75	-5.25	-5.0	-4.75	V
I_{CC}			1.5	2		1.5	2	mA
I_{DD}			50		50			μA
I_{SS}		-2.3	-1.5		-2.3	-1.5		mA
Power			15	20		15	20	mW

SPECIFICATIONS

At $T_A = T_{MIN}$ to T_{MAX} , $V_{DD} = V_{CC} = 5\text{ V}$, $V_{SS} = 0\text{ V}$, $V_{REFH} = 2.5\text{ V}$, and $V_{REFL} = 0\text{ V}$, unless otherwise noted

PARAMETER	TEST CONDITIONS	DAC7634E			DAC7634EB			UNIT
		MIN	TYP	MAX	MIN	TYP	MAX	
ACCURACY								
Linearity error ⁽¹⁾			±3	±4		±2	±3	LSB
Linearity match			±4			±2		LSB
Differential linearity error			±2	±3		±1	±2	LSB
Monotonicity, T_{MIN} to T_{MAX}		14			15			Bits
Zero-scale error			±1	±2		±1	±2	mV
Zero-scale error drift			5	10		5	10	ppm/°C
Full-scale error			±1	±2		±1	±2	mV
Full-scale error drift			5	10		5	10	ppm/°C
Zero-scale matching	Channel-to-channel matching		±1	±2		±1	±2	mV
Full-scale matching	Channel-to-channel matching		±1	±2		±1	±2	mV
Power supply rejection ratio (PSRR)	At full scale		10	100		10	100	ppm/V
ANALOG INPUT								
Voltage output	$V_{REFL} = 0\text{ V}$, $V_{SS} = 0\text{ V}$, $R_L = 10\text{ k}\Omega$	0		V_{REFH}	0		V_{REFH}	V
Output current		-1.25		1.25	-1.25		1.25	mA
Maximum load capacitance	No oscillation		500			500		pF
Short-circuit current			±30			±30		mA
Short-circuit duration	GND or V_{CC}		Indefinite			Indefinite		
REFERENCE INPUT								
Ref high input voltage range		$V_{REFL} + 1.25$		2.5	$V_{REFL} + 1.25$		2.5	V
Ref low input voltage range		0		$V_{REFH} - 1.25$	0		$V_{REFH} - 1.25$	V
Ref high input current			250			250		µA
Ref low input current			-250			-250		µA
DYNAMIC PERFORMANCE								
Settling time	To ±0.003%, 2.5-V output step		8	10		8	10	µs
Channel-to-channel crosstalk	See Figure 6		0.5			0.5		LSB
Digital feedthrough			2			2		nV-s
Output noise voltage	$f = 10\text{ kHz}$		60			60		nV/√Hz
DAC glitch	7FFF _H to 8000 _H or 8000 _H to 7FFF _H		40			40		nV-s
DIGITAL INPUT								
V_{IH}		$0.7 \times V_{DD}$			$0.7 \times V_{DD}$			V
V_{IL}		$0.3 \times V_{DD}$			$0.3 \times V_{DD}$			V
I_{IH}			±10			±10		µA
I_{IL}			±10			±10		µA
DIGITAL OUTPUT								
V_{OH}	$I_{OH} = -0.8\text{ mA}$	3.6	4.5		3.6	4.5		V
V_{OL}	$I_{OL} = 1.6\text{ mA}$		0.3	0.4		0.3	0.4	V
POWER SUPPLY								
V_{DD}		4.75	5.0	5.25	4.75	5.0	5.25	V
V_{CC}		4.75	5.0	5.25	4.75	5.0	5.25	V
V_{SS}		0	0	0	0	0	0	V
I_{CC}			1.5	2		1.5	2	mA
I_{DD}			50			50		µA
Power			7.5	10		7.5	10	mW

(1) If $V_{SS} = 0\text{ V}$ specification applies at Code 0040_H and above due to possible negative zero-scale error.

PIN DESCRIPTIONS

PIN	NAME	DESCRIPTION	PIN	NAME	DESCRIPTION
1	NC	No connection	25	V _{CC}	Analog +5-V power supply
2	NC	No connection	26	V _{CC}	Analog +5-V power supply
3	SDI	Serial data input	27	AGND	Analog ground
4	DGND	Digital ground	28	AGND	Analog ground
5	CLK	Data clock input	29	V _{SS}	Analog +5-V power supply or 0-V single supply
6	DGND	Digital ground	30	V _{SS}	Analog +5-V power supply or 0-V single supply
7	LDAC	DAC register load control, rising edge triggered	31	V _{OUTD}	DAC D output voltage
8	DGND	Digital ground	32	V _{OUTD} Sense	DAC D's output amplifier inverting input. Used to close feedback loop at load.
9	$\overline{\text{LOAD}}$	DAC input register load control, active low	33	V _{REFL} CD Sense	DAC C and D reference low sense input
10	DGND	Digital ground	34	V _{REFL} CD	DAC C and D reference low input
11	$\overline{\text{CS}}$	Chip select, active low	35	V _{REFH} CD	DAC C and D reference high input
12	DGND	Digital ground	36	V _{REFH} CD Sense	DAC C and D reference high sense input
13	SDO	Serial data output	37	V _{OUTC}	DAC C output voltage
14	DGND	Digital ground	38	V _{OUTC} Sense	DAC C's output amplifier inverting input. Used to close the feedback loop at the load.
15	RSTSEL	Reset Select. Determines the action of RST. If HIGH, a RST common sets the DAC registers to mid-scale (8000 _H). If LOW, a RST command sets the DAC registers to zero (0000 _H).	39	V _{OUTB}	DAC B output voltage
16	DGND	Digital ground	40	V _{OUTB} Sense	DAC B's output amplifier inverting input. Used to close the feedback loop at the load.
17	RST	Reset, rising edge triggered. Depending on the state of RSTSEL, the DAC registers are set to either mid-scale or zero.	41	V _{REFH} AB Sense	DAC A and B reference high sense input
18	DGND	Digital ground	42	V _{REFH} AB	DAC A and B reference high input
19	NC	No connection	43	V _{REFL} AB	DAC A and B reference low input
20	NC	No connection	44	V _{REFL} AB Sense	DAC A and B reference low sense input
21	DGND	Digital ground	45	V _{SS}	Analog –5-V power supply or 0-V single supply
22	DGND	Digital ground	46	AGND	Analog ground
23	V _{DD}	Digital 5-V power supply	47	V _{OUTA}	DAC A output voltage
24	V _{DD}	Digital 5-V power supply	48	V _{OUTA} Sense	DAC A's output amplifier inverting input. Used to close the feedback loop at the load.

PIN CONFIGURATION

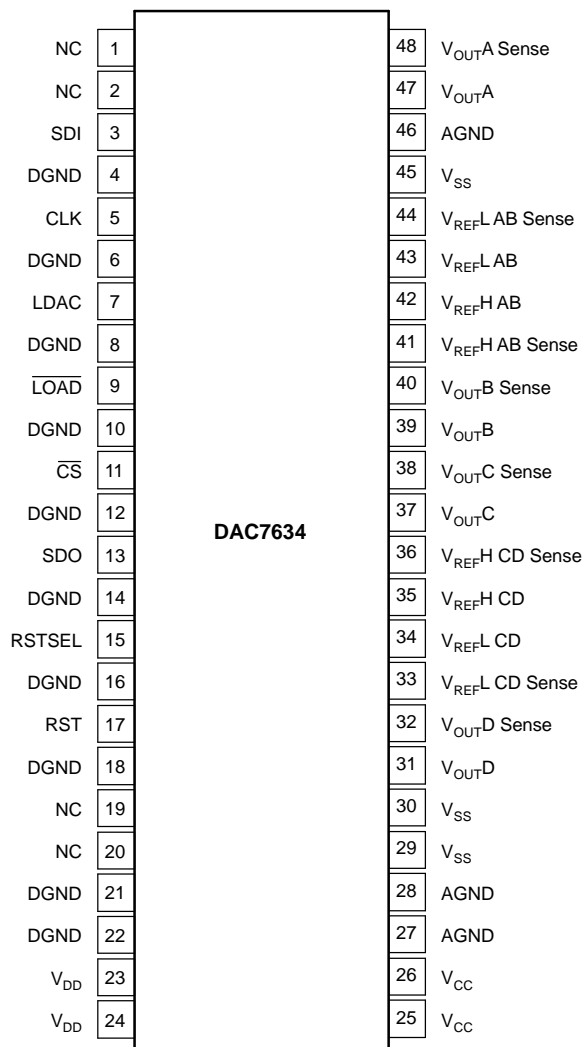

TYPICAL PERFORMANCE CURVES: $V_{SS} = 0$ V

At $T_A = 25^\circ\text{C}$, $V_{DD} = V_{CC} = 5$ V, $V_{REFH} = 2.5$ V, $V_{REFL} = 0$ V, representative unit, unless otherwise specified.

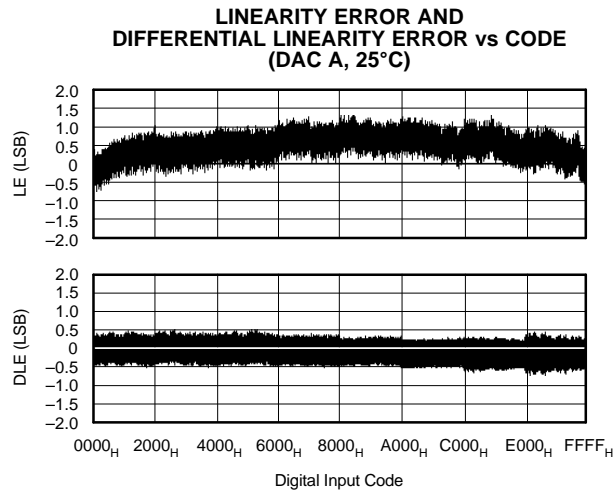

Figure 1.

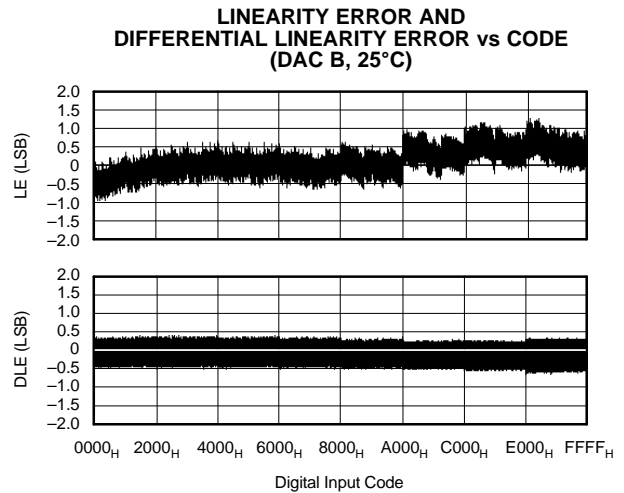

Figure 2.

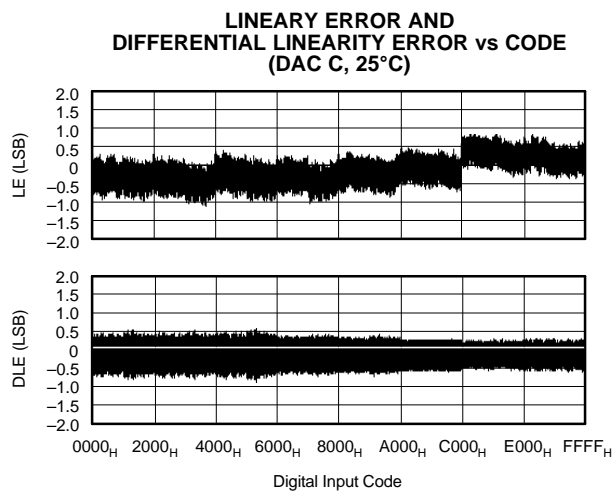

Figure 3.

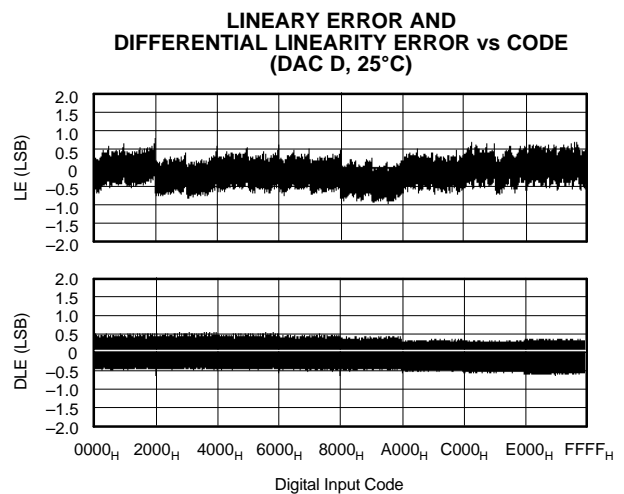

Figure 4.

TYPICAL PERFORMANCE CURVES: $V_{SS} = 0$ V (continued)

At $T_A = 25^\circ\text{C}$, $V_{DD} = V_{CC} = 5$ V, $V_{REFH} = 2.5$ V, $V_{REFL} = 0$ V, representative unit, unless otherwise specified.

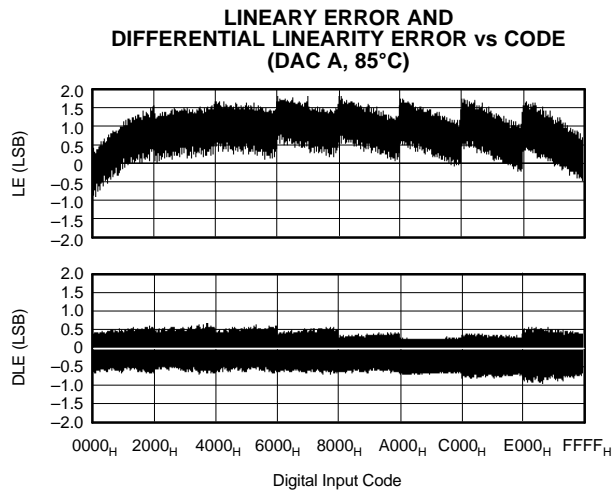

Figure 5.

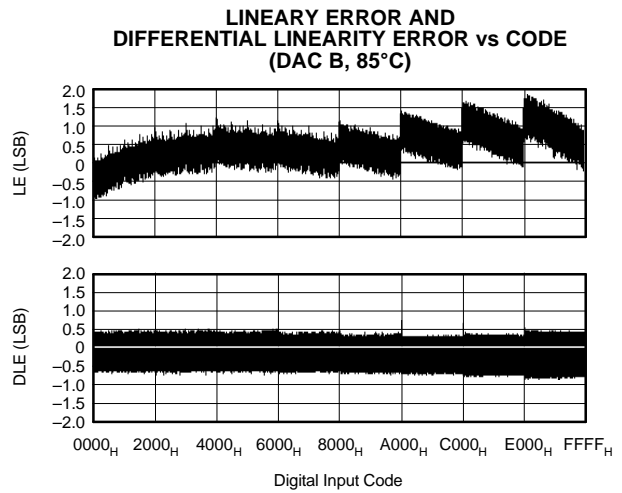

Figure 6.

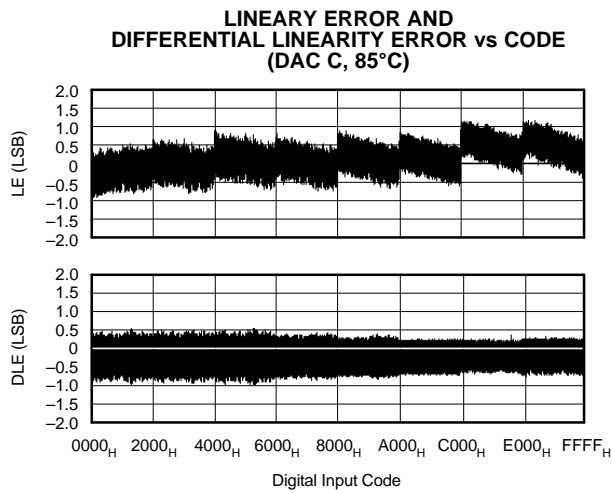

Figure 7.

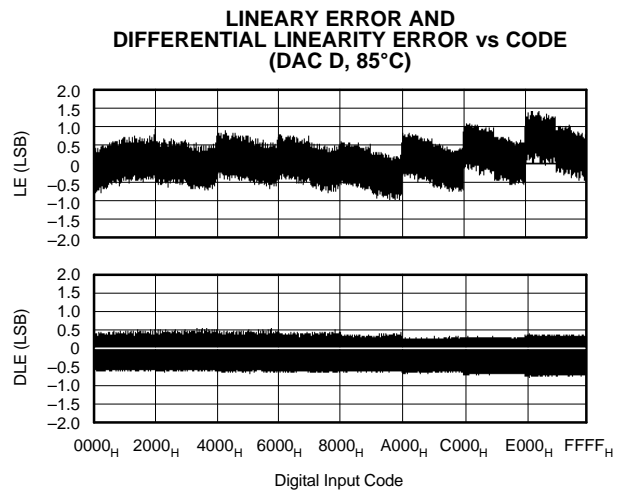

Figure 8.

TYPICAL PERFORMANCE CURVES: $V_{SS} = 0\text{ V}$ (continued)

At $T_A = 25^\circ\text{C}$, $V_{DD} = V_{CC} = 5\text{ V}$, $V_{REFH} = 2.5\text{ V}$, $V_{REFL} = 0\text{ V}$, representative unit, unless otherwise specified.

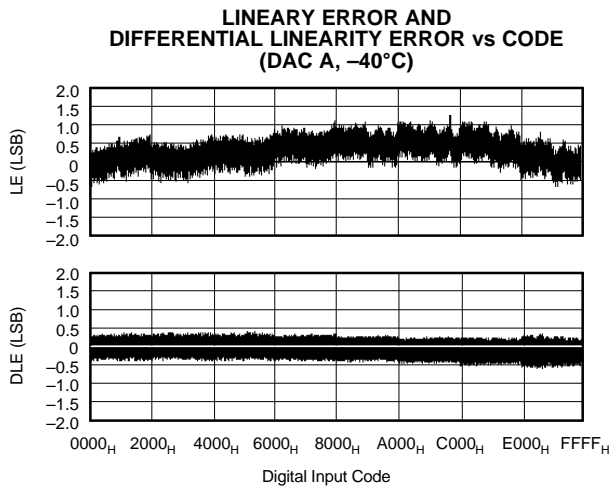

Figure 9.

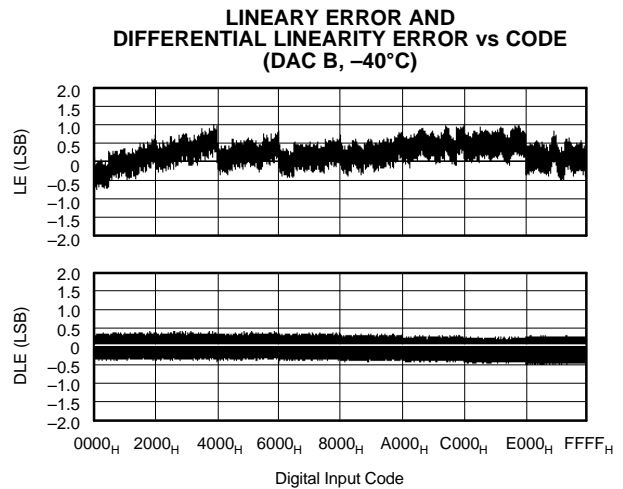

Figure 10.

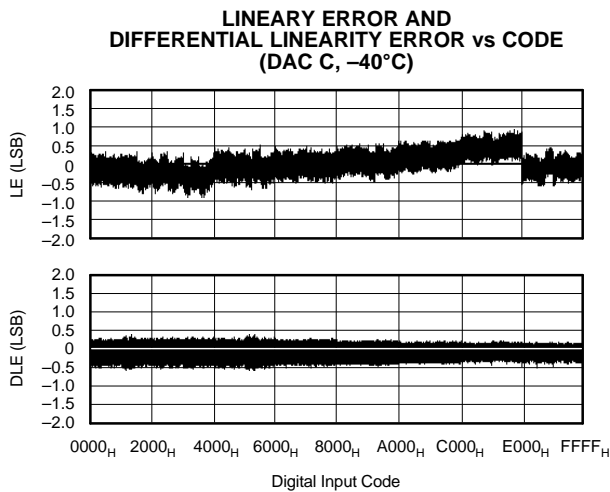

Figure 11.

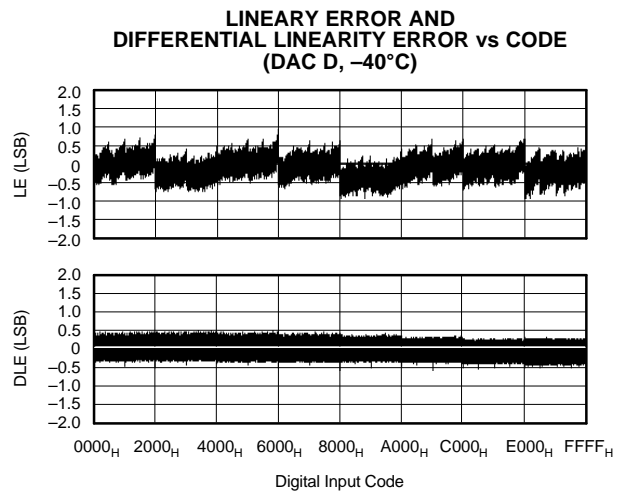

Figure 12.

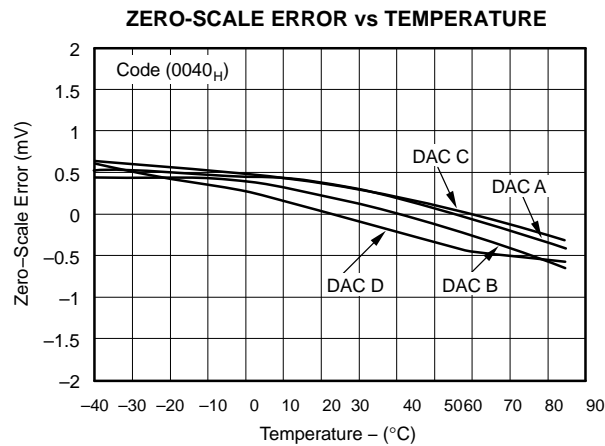

Figure 13.

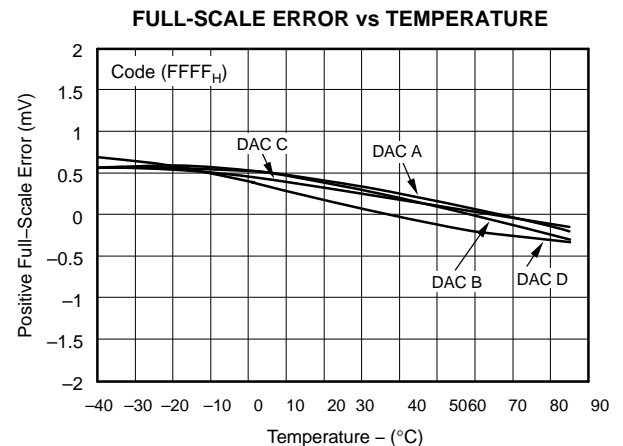

Figure 14.

TYPICAL PERFORMANCE CURVES: $V_{SS} = 0$ V (continued)

At $T_A = 25^\circ\text{C}$, $V_{DD} = V_{CC} = 5$ V, $V_{REFH} = 2.5$ V, $V_{REFL} = 0$ V, representative unit, unless otherwise specified.

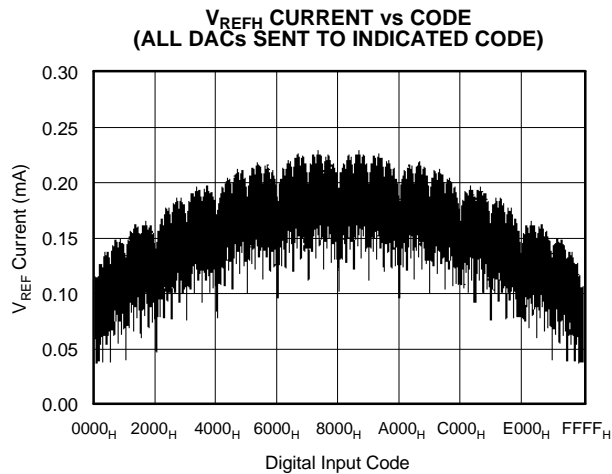

Figure 15.

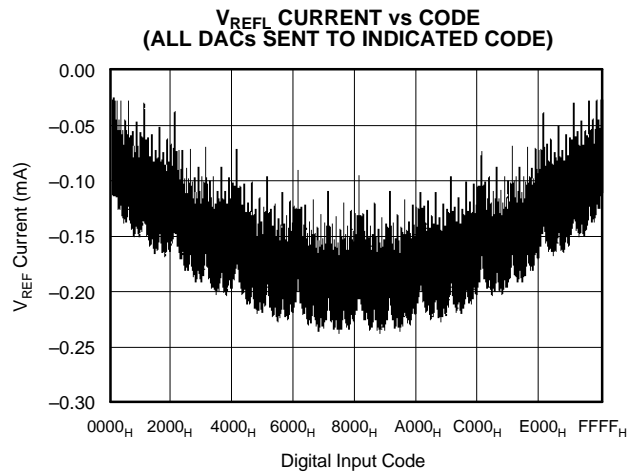

Figure 16.

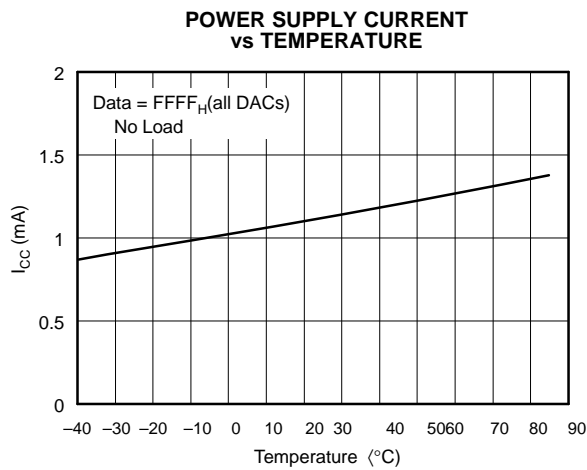

Figure 17.

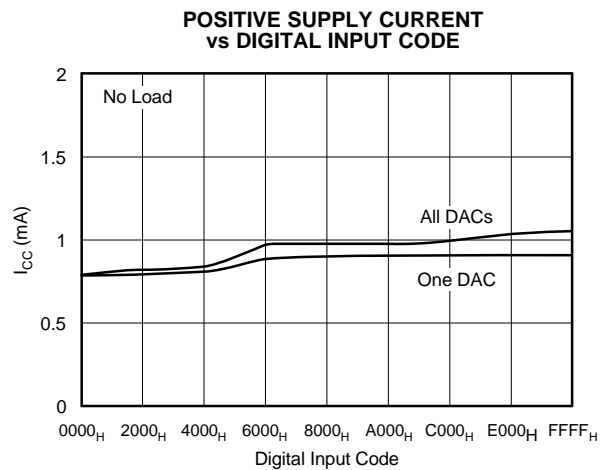

Figure 18.

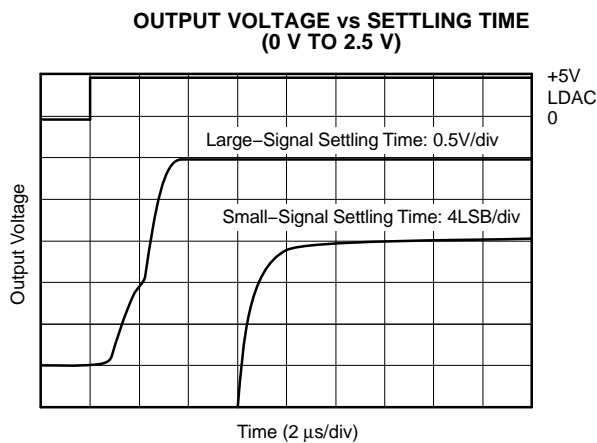

Figure 19.

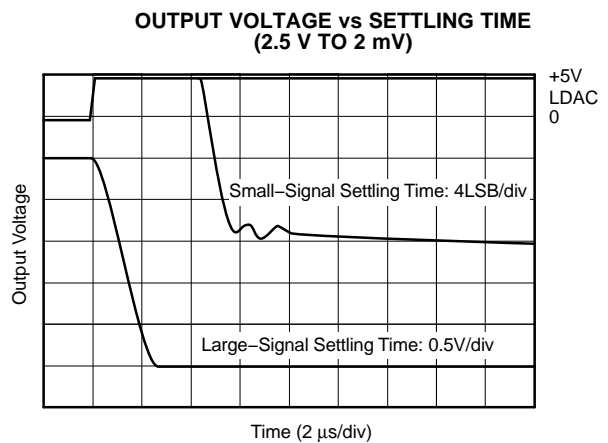

Figure 20.

TYPICAL PERFORMANCE CURVES: $V_{SS} = 0$ V (continued)

At $T_A = 25^\circ\text{C}$, $V_{DD} = V_{CC} = 5$ V, $V_{REFH} = 2.5$ V, $V_{REFL} = 0$ V, representative unit, unless otherwise specified.

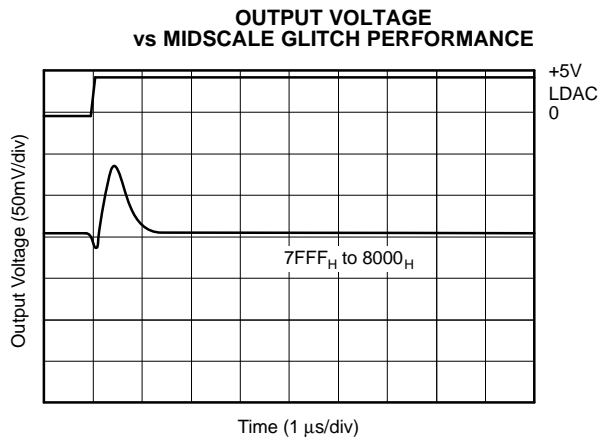

Figure 21.

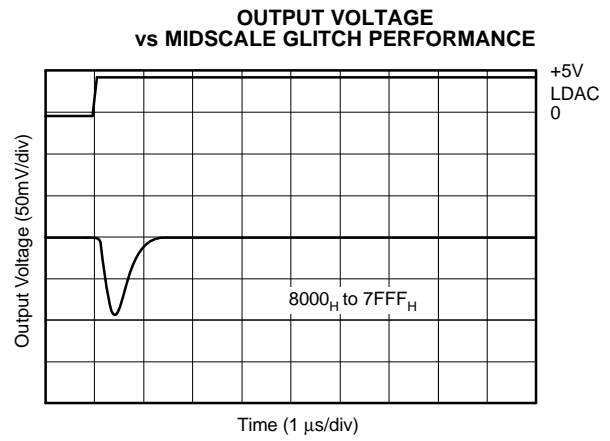

Figure 22.

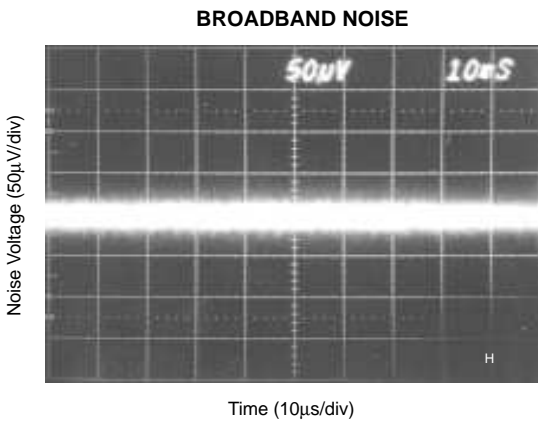

Figure 23.

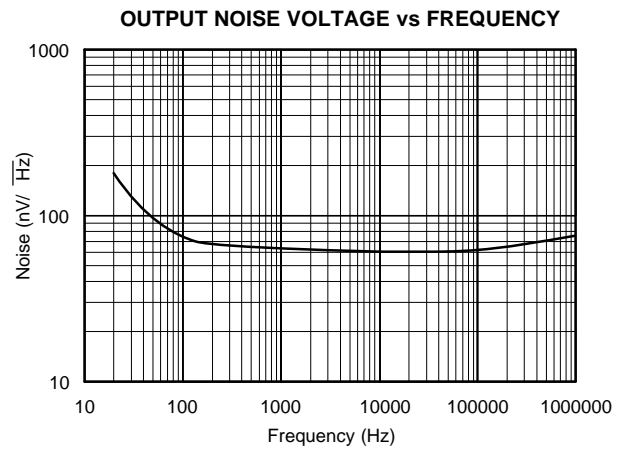

Figure 24.

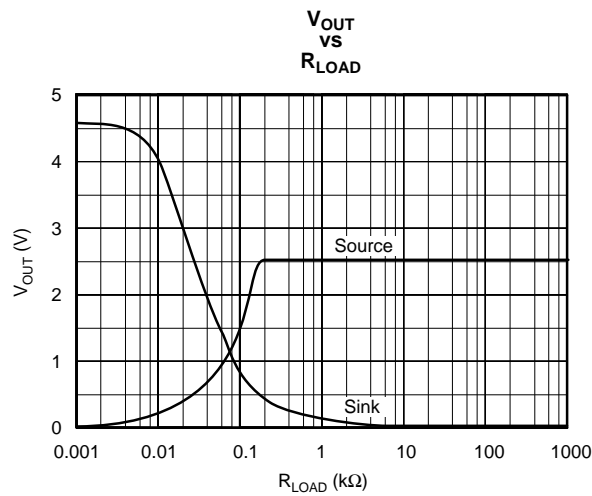

Figure 25.

TYPICAL PERFORMANCE CURVES: $V_{SS} = -5\text{ V}$

At $T_A = 25^\circ\text{C}$, $V_{DD} = V_{CC} = 5\text{ V}$, $V_{REFH} = 2.5\text{ V}$, $V_{REFL} = 0\text{ V}$, representative unit, unless otherwise specified.

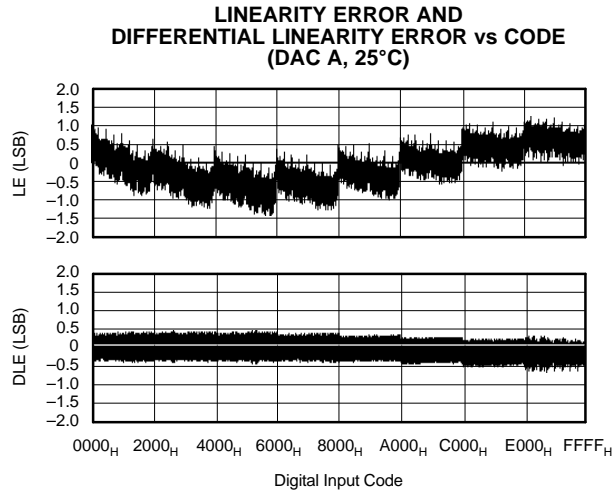

Figure 26.

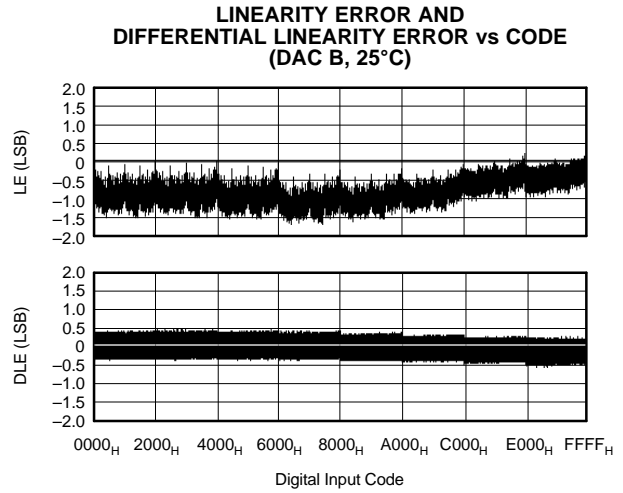

Figure 27.

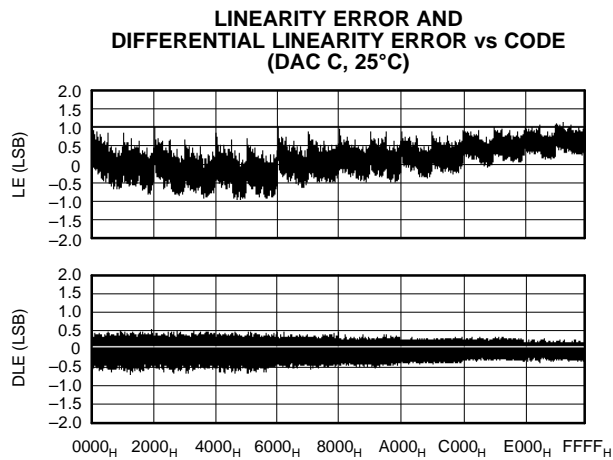

Figure 28.

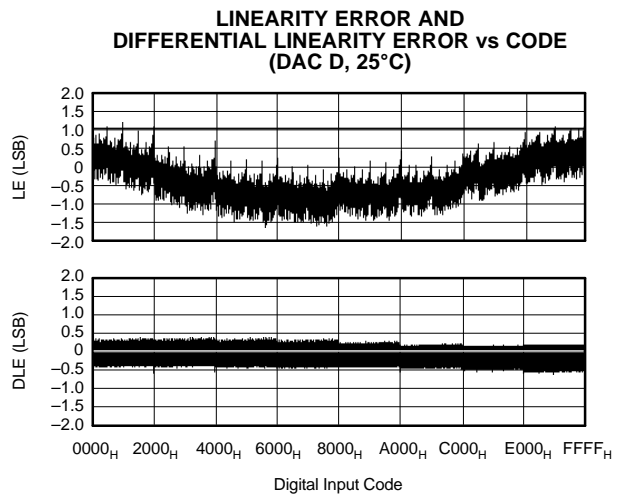

Figure 29.

TYPICAL PERFORMANCE CURVES: $V_{SS} = -5\text{ V}$ (continued)

At $T_A = 25^\circ\text{C}$, $V_{DD} = V_{CC} = 5\text{ V}$, $V_{REFH} = 2.5\text{ V}$, $V_{REFL} = 0\text{ V}$, representative unit, unless otherwise specified.

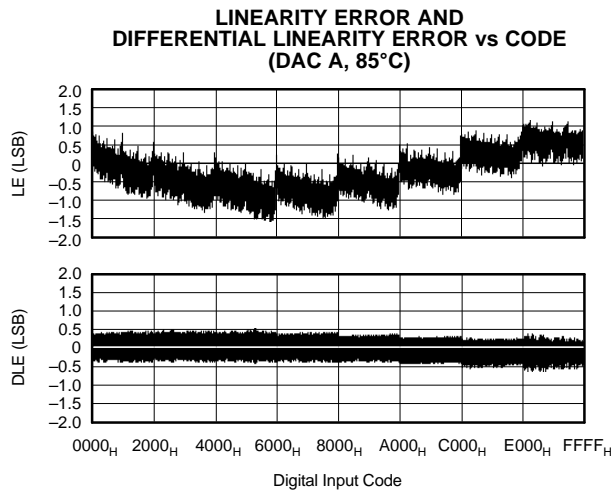

Figure 30.

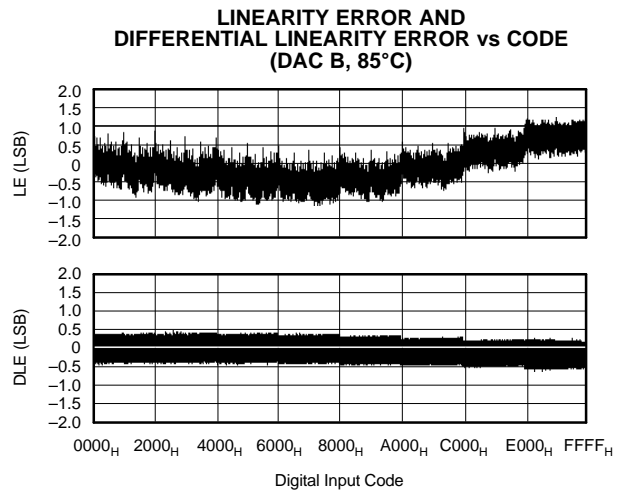

Figure 31.

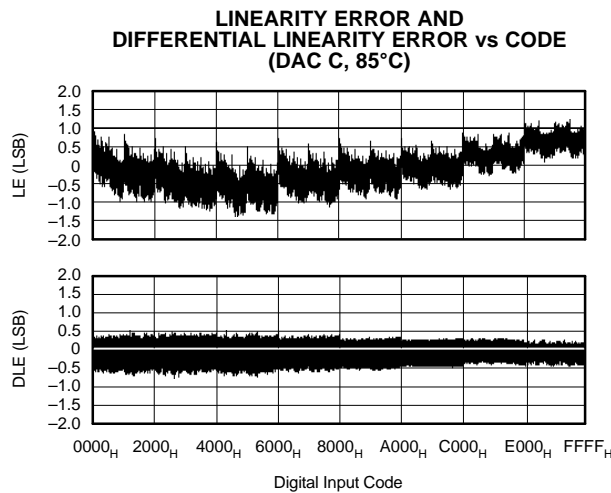

Figure 32.

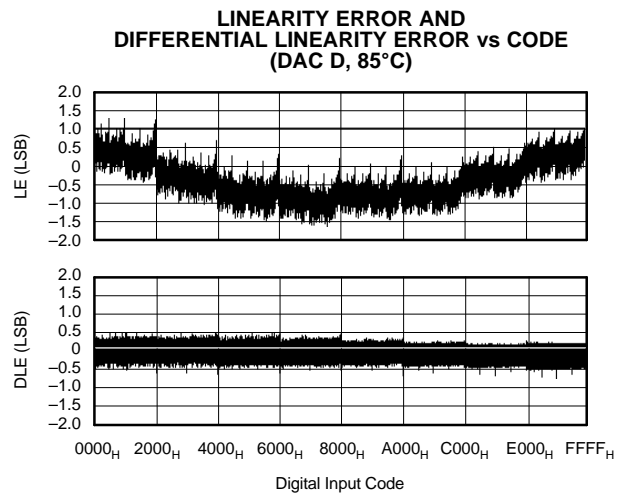

Figure 33.

TYPICAL PERFORMANCE CURVES: $V_{SS} = -5\text{ V}$ (continued)

At $T_A = 25^\circ\text{C}$, $V_{DD} = V_{CC} = 5\text{ V}$, $V_{REFH} = 2.5\text{ V}$, $V_{REFL} = 0\text{ V}$, representative unit, unless otherwise specified.

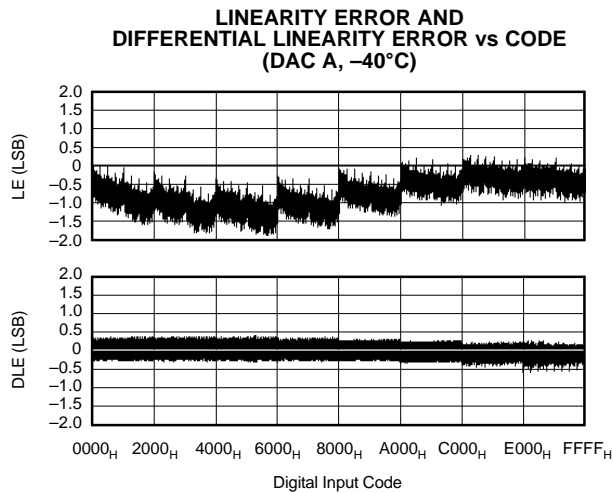

Figure 34.

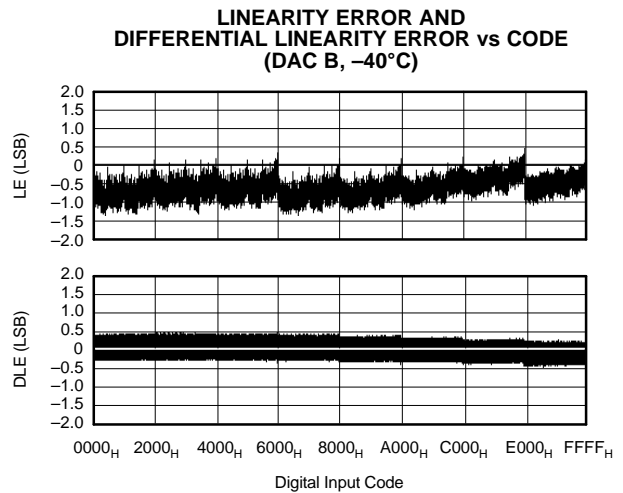

Figure 35.

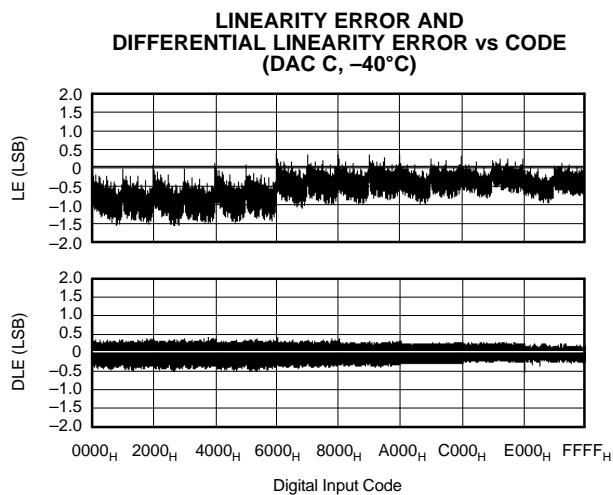

Figure 36.

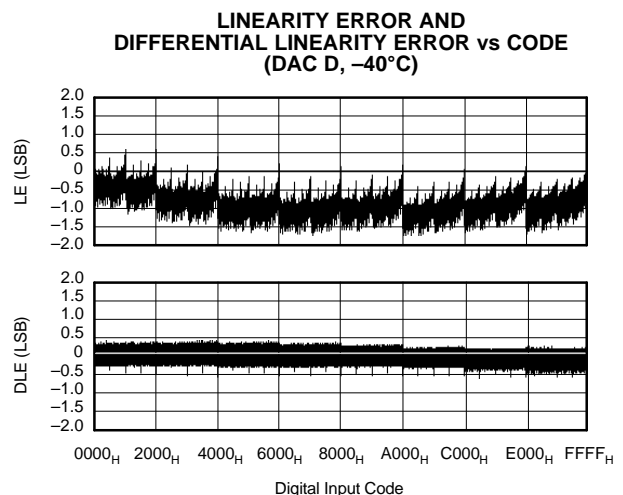

Figure 37.

TYPICAL PERFORMANCE CURVES: $V_{SS} = -5\text{ V}$ (continued)

At $T_A = 25^\circ\text{C}$, $V_{DD} = V_{CC} = 5\text{ V}$, $V_{REFH} = 2.5\text{ V}$, $V_{REFL} = 0\text{ V}$, representative unit, unless otherwise specified.

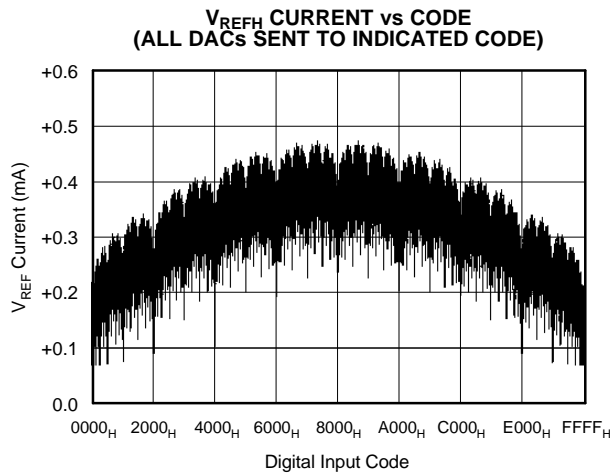

Figure 38.

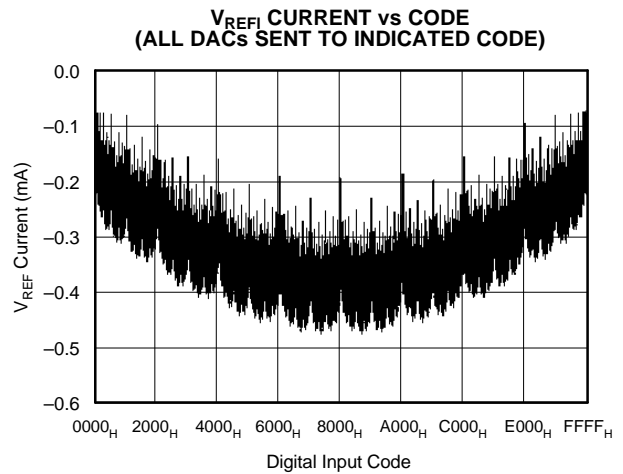

Figure 39.

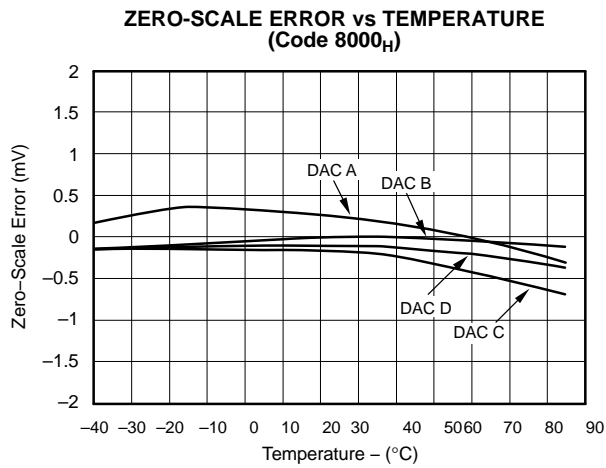

Figure 40.

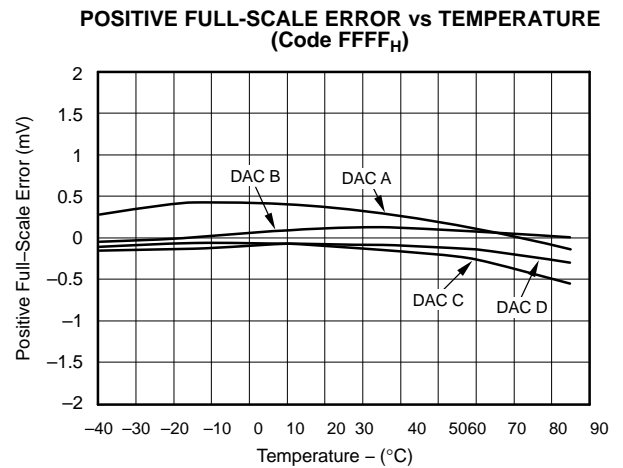

Figure 41.

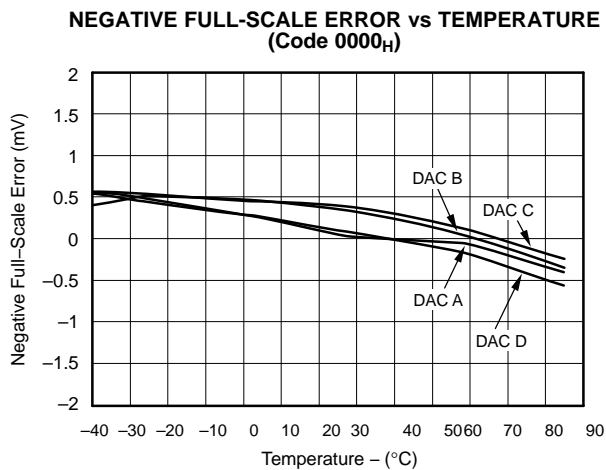

Figure 42.

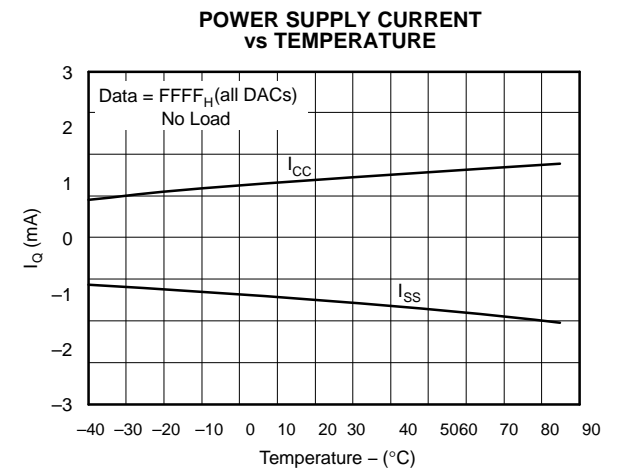

Figure 43.

TYPICAL PERFORMANCE CURVES: $V_{SS} = -5\text{ V}$ (continued)

At $T_A = 25^\circ\text{C}$, $V_{DD} = V_{CC} = 5\text{ V}$, $V_{REFH} = 2.5\text{ V}$, $V_{REFL} = 0\text{ V}$, representative unit, unless otherwise specified.

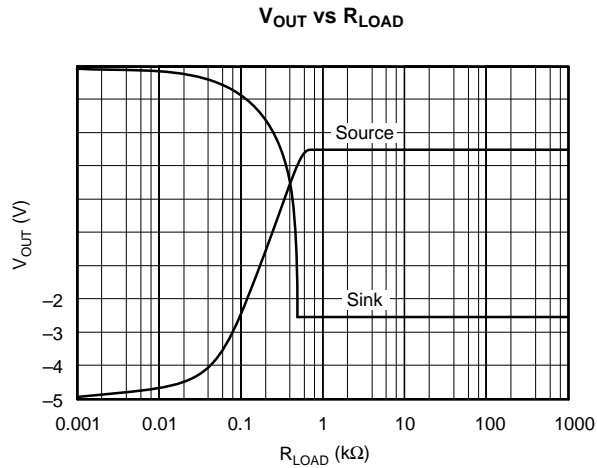

Figure 44.

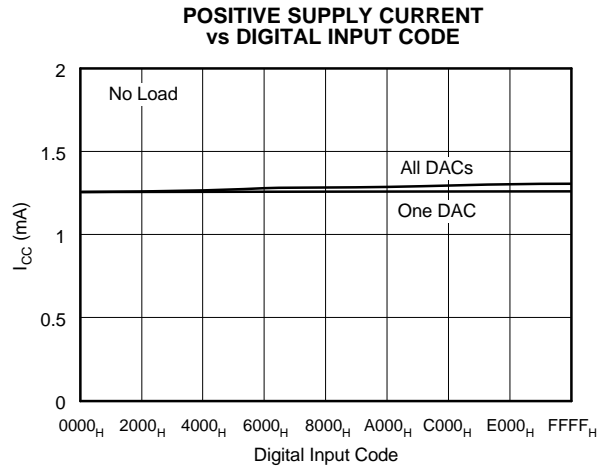

Figure 45.

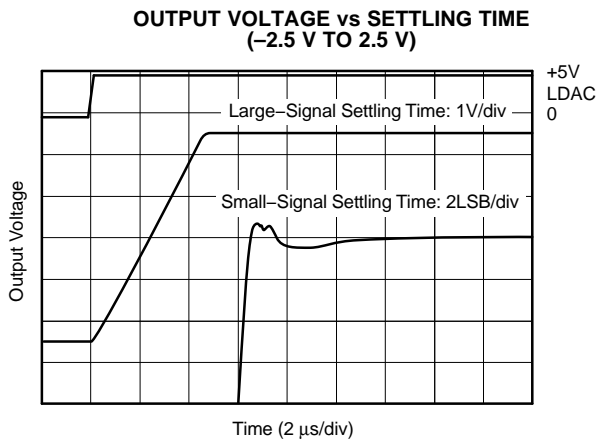

Figure 46.

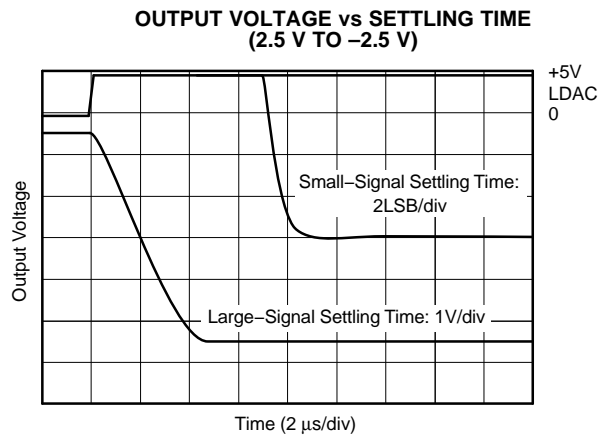

Figure 47.

THEORY OF OPERATION

The DAC7634 is a quad voltage output, 16-bit digital-to-analog converter (DAC). The architecture is an R-2R ladder configuration with the three MSBs segmented, followed by an operational amplifier that serves as a buffer. Each DAC has its own R-2R ladder network, segmented MSBs, and output operational amplifier, as shown in Figure 48. The minimum voltage output (zero-scale) and maximum voltage output (full-scale) are set by the external voltage references (V_{REFL} and V_{REFH} , respectively).

The digital input is a 24-bit serial word that contains a 2-bit address code for selecting one of four DACs, a quick load bit, five unused bits, and the 16-bit DAC code (MSB first). The converters can be powered from either a single 5-V supply or a dual $\pm 5\text{-V}$ supply. The device offers a reset function which immediately sets all DAC output voltages and DAC registers to mid-scale code 8000_H or to zero-scale, code 0000_H . See Figure 49 and Figure 50 for the basic operation of the DAC7634.

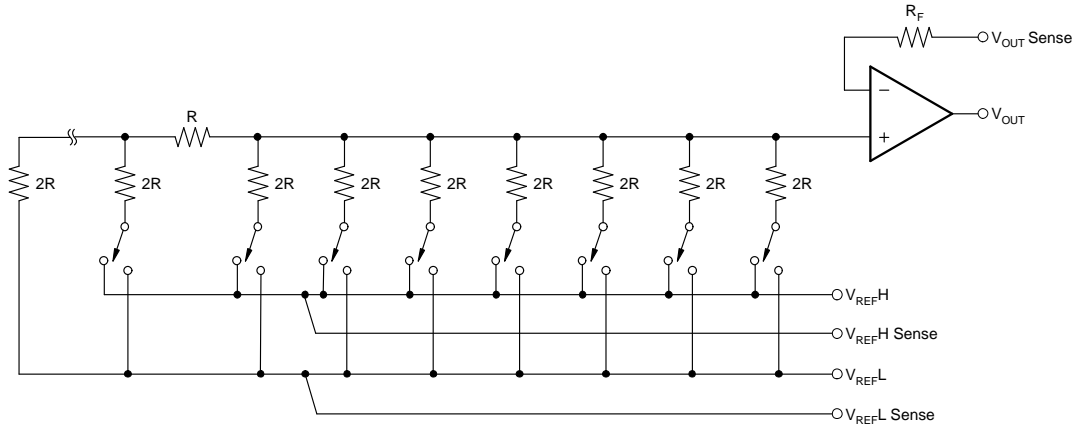

Figure 48. DAC7634 Architecture

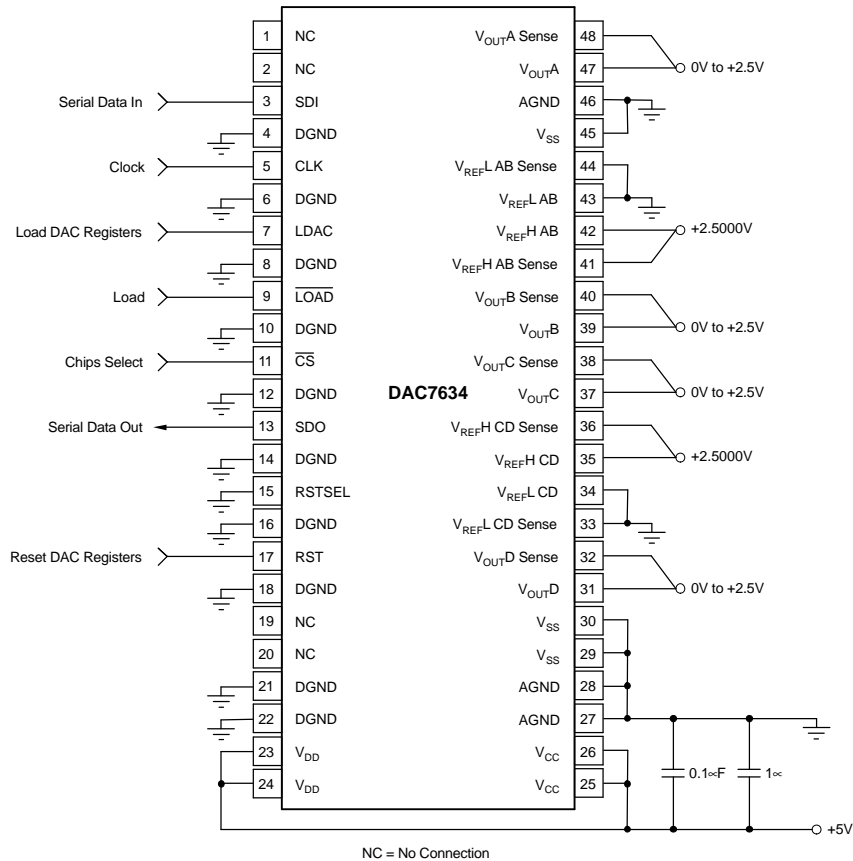

Figure 49. Basic Single-Supply Operation of the DAC7634

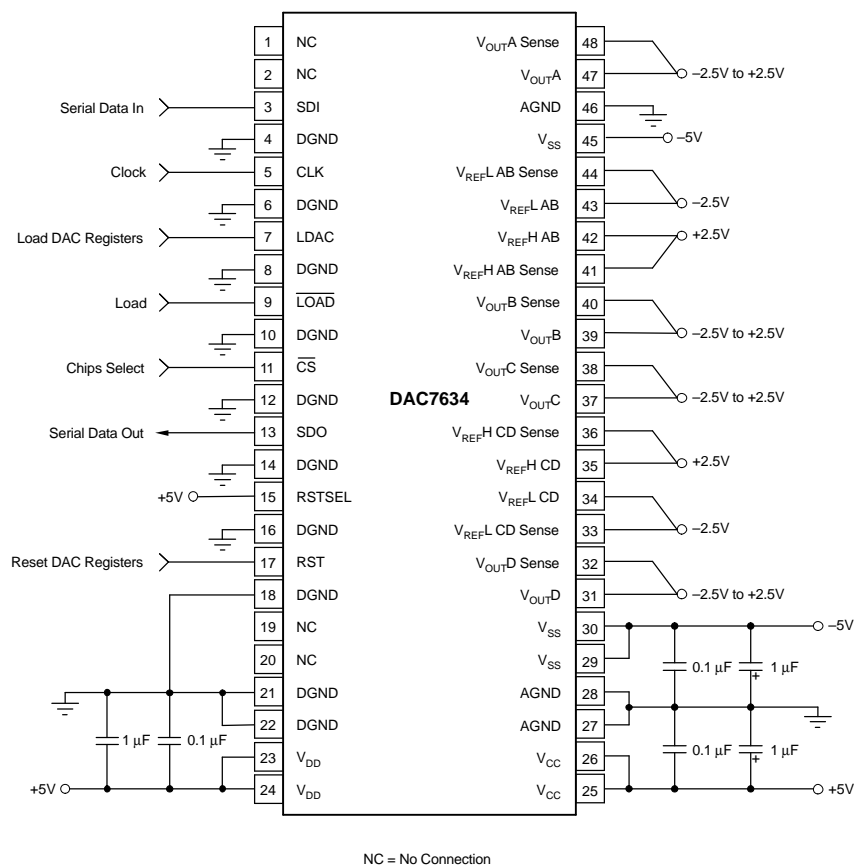

Figure 50. Basic Dual-Supply Operation of the DAC7634

ANALOG OUTPUTS

When $V_{SS} = -5V$ (dual supply operation), the output amplifier can swing to within 2.25 V of the supply rails, specified over the $-40^{\circ}C$ to $85^{\circ}C$ temperature range. When $V_{SS} = 0 V$ (single-supply operation), and with R_{LOAD} also connected to ground, the output can swing to ground. Care must also be taken when measuring the zero-scale error when $V_{SS} = 0 V$. Because the output voltage cannot swing below ground, the output voltage may not change for the first few digital input codes (0000_H, 0001_H, 0002_H, etc.) if the output amplifier has a negative offset. At the negative limit of $-2 mV$, the first specified output starts at code 0040_H.

Due to the high accuracy of these D/A converters, system design problems such as grounding and contact resistance become important. A 16-bit

converter with a 2.5 V full-scale range has a 1-LSB value of 38 μV . With a load current of 1 mA, series wiring and connector resistance of only 40 $m\Omega$ (R_{W2}) causes a voltage drop of 40 μV , as shown in Figure 51. To understand what this means in terms of a system layout, the resistivity of a typical 1-ounce copper-clad printed-circuit board is 1.2 $m\Omega$ per square. For a 1-mA load, a 10-mil wide printed-circuit conductor 600 mil long results in a voltage drop of 30 μV .

The DAC7634 offers a force and sense output configuration for the high open-loop gain output amplifier. This feature allows the loop around the output amplifier to be closed at the load (as shown in Figure 51), thus ensuring an accurate output voltage.

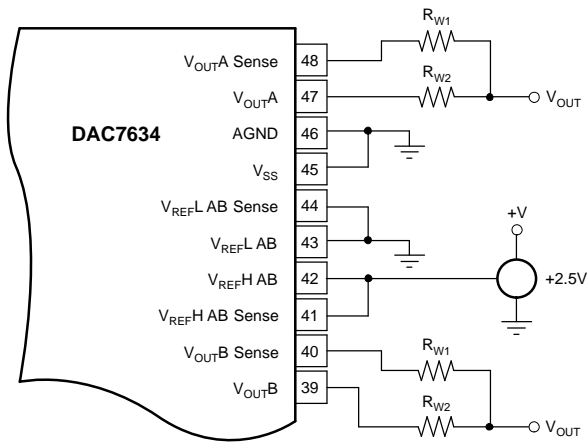

Figure 51. Analog Output Closed-Loop Configuration (1/2 DAC7634)
(R_W Represents Wiring Resistances)

REFERENCE INPUTS

The reference inputs, V_{REFL} and V_{REFH} , can be any voltage between $V_{SS} + 2.5\text{ V}$ and $V_{CC} - 2.5\text{ V}$, provided that V_{REFH} is at least 1.25 V greater than

V_{REFL} . The minimum output of each DAC is equal to V_{REFL} plus a small offset voltage (essentially, the offset of the output operational amp). The maximum output is equal to V_{REFH} plus a similar offset voltage. Note that V_{SS} (the negative power supply) must either be connected to ground or must be in the range of -4.75 V to -5.25 V . The voltage on V_{SS} sets several bias points within the converter. If V_{SS} is not in one of these two configurations, the bias values may be in error and proper operation of the device is not specified.

The current into the V_{REFH} input and out of V_{REFL} depends on the DAC output voltages, and can vary from a few microamps to approximately 0.5 mA. The reference input appears as a varying load to the reference. If the reference can sink or source the required current, a reference buffer is not required. The DAC7634 features a reference drive and sense connection such that the internal errors caused by the changing reference current and the circuit impedances can be minimized. Figure 52 through Figure 60 show different reference configurations, and the effect on the linearity and differential linearity.

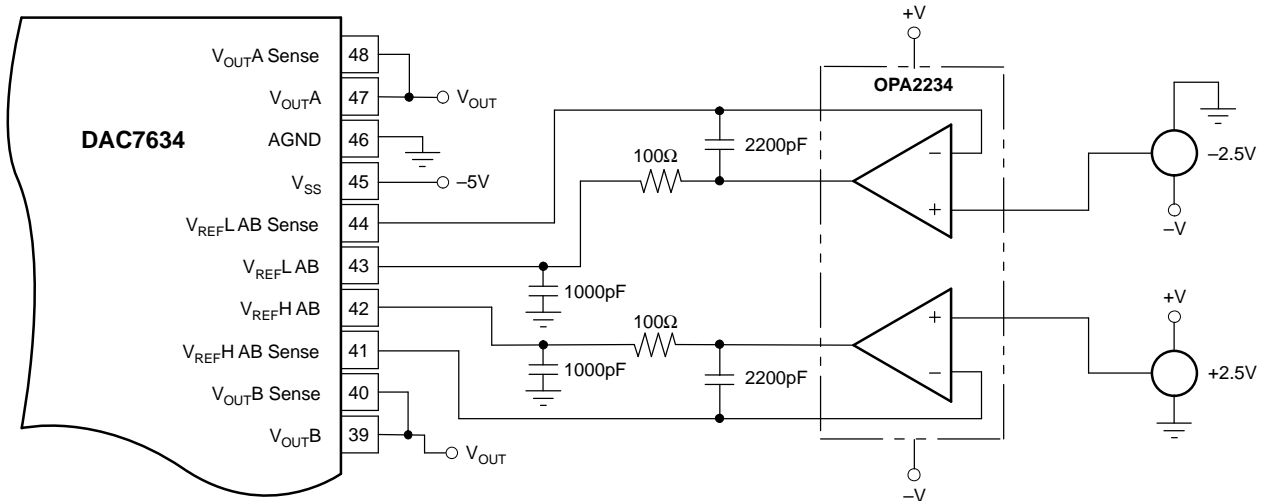
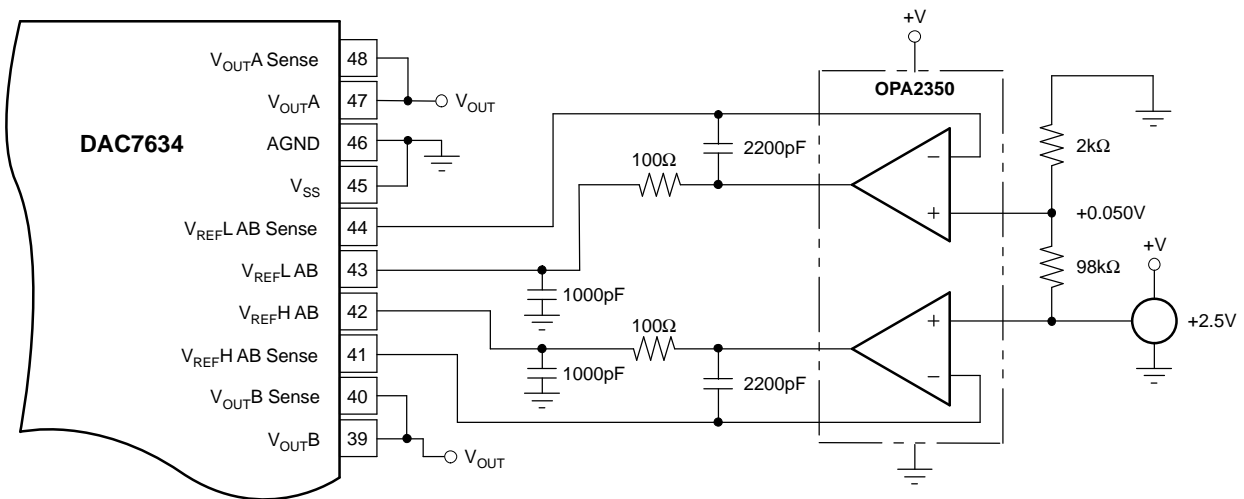

Figure 52. Dual Supply Configuration-Buffered References, Used for Dual Supply Performance



NOTE: V_{REFL} has been chosen to be 50 mV to allow for current sinking voltage drops across the 100- Ω resistor and the output stage of the buffer operational amplifier.

Figure 53. Single-Supply Buffered Reference With a Reference Low of 50 mV (1/2 DAC7634)

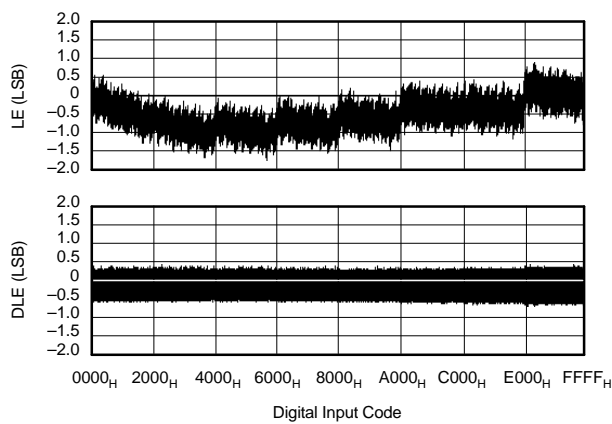

Figure 54. Integral Linearity and Differential Linearity Error Curves for Figure 53

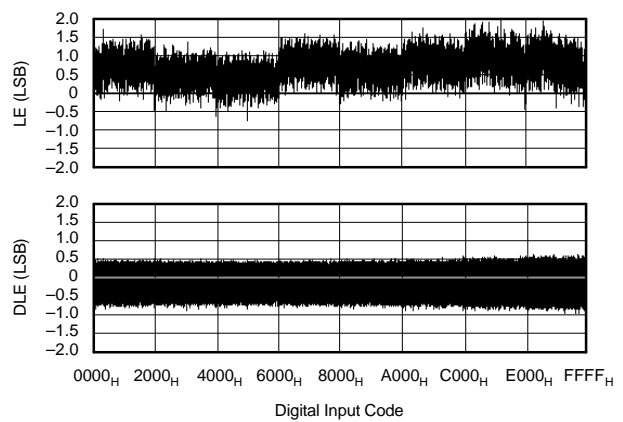

Figure 55. Integral Linearity and Differential Linearity Error Curves for Figure 56

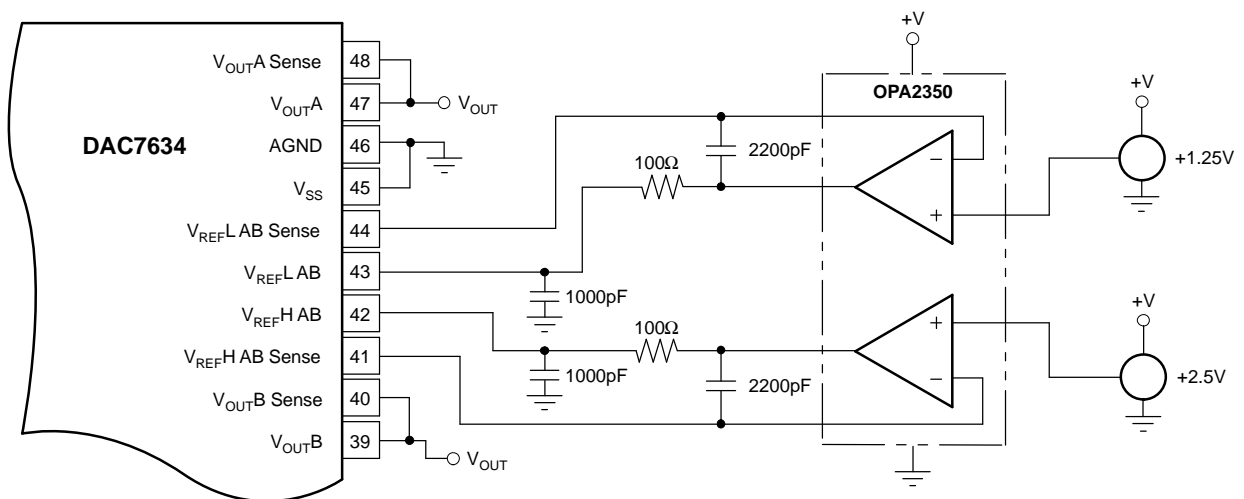

Figure 56. Single-Supply Buffered Reference With $V_{REFL} = 1.25$ V and $V_{REFH} = 2.5$ V (1/2 DAC7634)

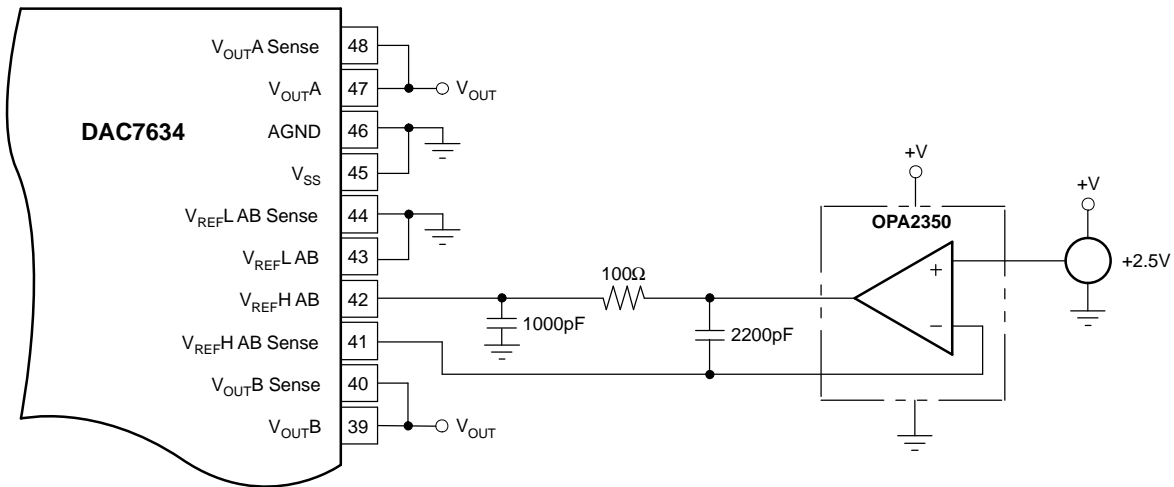

Figure 57. Single-Supply Buffered V_{REFH} (1/2 DAC7634)

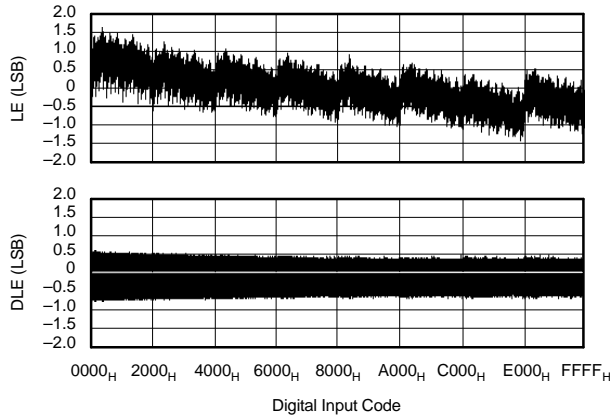

Figure 58. Linearity and Differential Linearity Error Curves for Figure 57

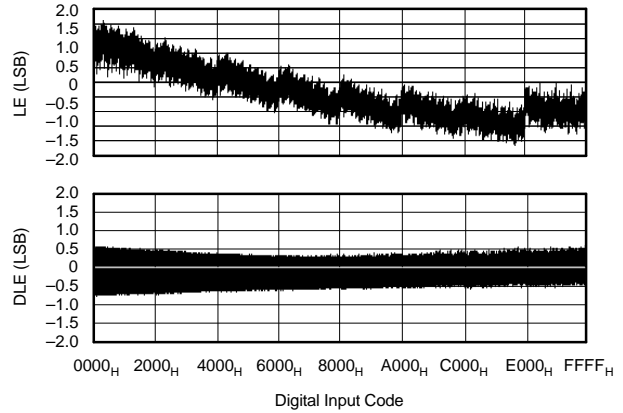

Figure 59. Linearity and Differential Linearity Error Curves for Figure 60

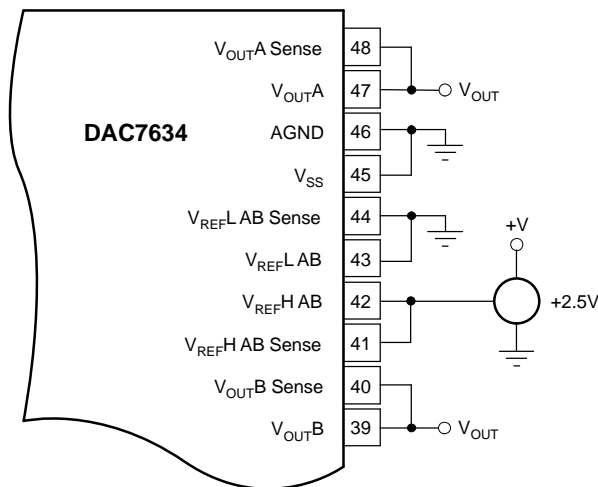

Figure 60. Low Cost Single-Supply Configuration

DIGITAL INTERFACE

Table 1 shows the basic control logic for the DAC7634. The interface consists of a signal data clock (CLK) input, serial data (SDI), DAC input register load control signal (\overline{LOAD}), and DAC register load control signal (LDAC). In addition, a chip select (\overline{CS}) input is available to enable serial communication when there are multiple serial devices. An asynchronous reset (RST) input, by the rising edge, is provided to simplify start-up conditions, periodic resets, or emergency resets to a known state, depending on the status of the reset select (RSTSEL) signal.

The DAC code, quick load control, and address are provided via a 24-bit serial interface (see Figure 15). The first two bits select the input register that is updated when \overline{LOAD} goes LOW. The third bit is a *Quick Load* bit such that if HIGH, the code in the shift register is loaded into ALL DAC's input register when \overline{LOAD} signal goes LOW. If the *Quick Load* bit is LOW, the content of shift register is loaded only to the DAC input register that is addressed. The *Quick Load* bit is followed by five unused bits. The last sixteen bits (MSB first) are the DAC code.

SERIAL DATA INPUT

B23	B22	B21	B20	B19	B18	B17	B16	B15	B14	B13	B12	B11	B10	B9	B8	B7	B6	B5	B4	B3	B2	B1	B0
A1	A0	QUICK LOAD	X	X	X	X	X	D15	D14	D13	D12	D11	D10	D9	D8	D7	D6	D5	D4	D3	D2	D1	D0

Table 1. DAC7634 Logic Truth Table⁽¹⁾

A1	A0	\overline{CS}	RST	RSTSEL	LDAC	\overline{LOAD}	INPUT REGISTER	DAC REGISTER	MODE	DAC
L	L	L	H	X	X	L	Write	Hold	Write Input	A
L	H	L	H	X	X	L	Write	Hold	Write Input	B
H	L	L	H	X	X	L	Write	Hold	Write Input	C
H	H	L	H	X	X	L	Write	Hold	Write Input	D
X	X	H	H	X	↑	H	Hold	Write	Update	All
X	X	H	H	X	H	H	Hold	Hold	Hold	All
X	X	X	↑	L	X	X	Reset to Zero	Reset to Zero	Reset to Zero	All
X	X	X	↑	H	X	X	Reset to Midscale	Reset to Midscale	Reset to Midscale	All

(1) If the DAC7634 is the only device on the serial bus, the \overline{CS} pin can be connected to DGND permanently, which enables the shift register all the time. In this case, only the CLK operates the serial shift register and all other functions listed in Table 1 should be followed as shown. The DAC updates on the rising edge of LDAC.

The internal DAC register is edge-triggered and not level-triggered. When the LDAC signal is transitioned from LOW to HIGH, the digital word currently in the DAC input register is latched. The first set of registers (the DAC input registers) are level-triggered via the \overline{LOAD} signal. This double-buffered architecture has been designed so that new data can be entered for each DAC without disturbing the analog outputs. When the new data has been entered into the device, all of the DAC outputs can be updated simultaneously by the rising edge of LDAC. Additionally, it allows the DAC input registers to be written to at any point, then the DAC output voltages can be synchronously changed via a trigger signal (LDAC).

Note that \overline{CS} and CLK are combined with an OR

gate, which controls the serial-to-parallel shift register. These two inputs are completely interchangeable. In addition, care must be taken with the state of CLK when \overline{CS} rises at the end of a serial transfer. If CLK is LOW when \overline{CS} rises, the OR gate provides a rising edge to the shift register, shifting the internal data one additional bit. The result will be incorrect data and possible selection of the wrong input register(s). If both \overline{CS} and CLK are used, \overline{CS} should rise only when CLK is HIGH. If not, then either \overline{CS} or CLK can be used to operate the shift register. See Table 2 for more information.

SERIAL-DATA OUTPUT

Table 2. Serial Shift Register Truth Table

\overline{CS} (1)	CLK(1)	\overline{LOAD}	RST	SERIAL SHIFT REGISTER
H(2)	X(3)	H	H	No Change
L(4)	L	H	H	No Change
L	↑(5)	H	H	Advanced One Bit
↑	L	H	H	Advanced One Bit
H(6)	X	L(7)	H	No Change
H(6)	X	H	↑(8)	No Change

- (1) \overline{CS} and CLK are interchangeable.
- (2) H = Logic HIGH
- (3) X = Don't Care
- (4) L = Logic LOW
- (5) Positive logic transition
- (6) A HIGH value is suggested in order to avoid a *false clock* from advancing the shift register and changing the shift register.
- (7) If data is clocked into the serial register while \overline{LOAD} is LOW, the selected DAC register changes as the shift register bits *flow* through A1 and A0. This corrupts the data in each DAC register that has been erroneously selected.
- (8) Rising edge of RST causes no change in the contents of the serial shift register.

The Serial-Data Output (SDO) is the internal shift register's output. For DAC7634, the SDO is a driven output and does not require an external pull-up. Any number of DAC7634s can be daisy-chained by connecting the SDO pin of one device to the SDI pin of the following device in the chain, as shown in [Figure 61](#).

DIGITAL TIMING

[Figure 62](#) and [Table 3](#) provide detailed timing for the digital interface of the DAC7634.

DIGITAL INPUT CODING

The DAC7634 input data is in straight binary format. The output voltage is given by [Equation 1](#).

Where N is the digital input code. This equation does not include the effects of offset (zero-scale) or gain (full-scale) errors.

$$V_{OUT} = V_{REF}^L + \frac{(V_{REF}^H - V_{REF}^L) \times N}{65,536} \quad (1)$$

DIGITALLY-PROGRAMMABLE CURRENT

SOURCE

The DAC7634 offers a unique set of features that allows a wide range of flexibility in designing applications circuits such as programmable current sources. The DAC7634 offers both a differential reference input, as well as an open-loop configuration around the output amplifier. The open-loop configuration around the output amplifier allows a transistor to be placed within the loop to implement a digitally- programmable, unidirectional current source. The availability of a differential reference allows programmability for both the full-scale and zero-scale currents. The output current is calculated as:

$$I_{OUT} = \left[\left(\frac{V_{REF}^H - V_{REF}^L}{R_{SENSE}} \right) \times \left(\frac{N}{65,536} \right) \right] + \left(V_{REF}^L / R_{SENSE} \right) \quad (2)$$

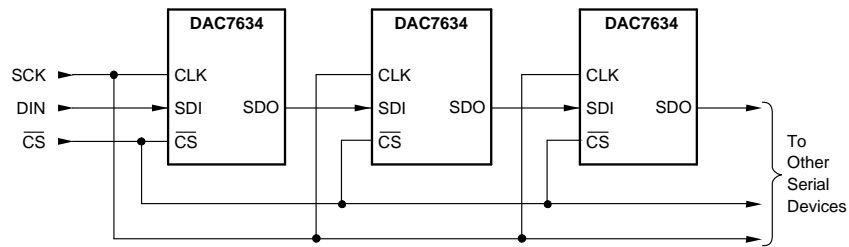

Figure 61. Daisy-Chaining DAC7634

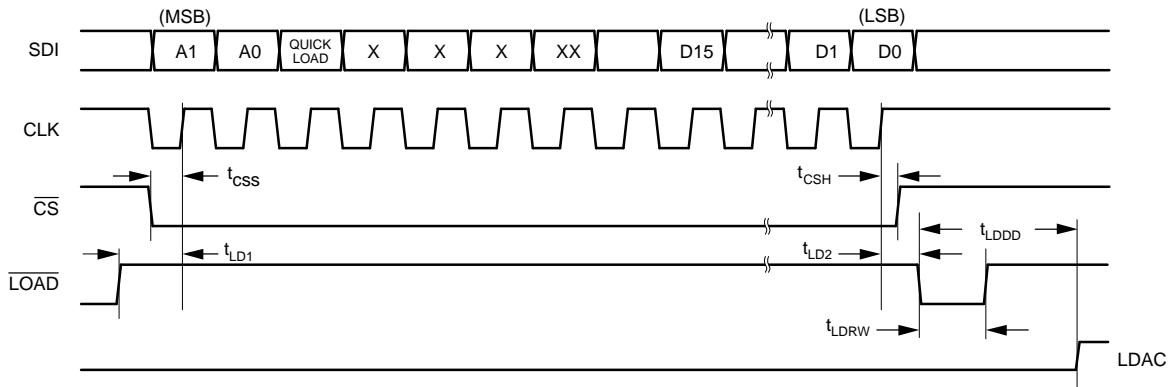

Figure 62. Serial Interface Timing

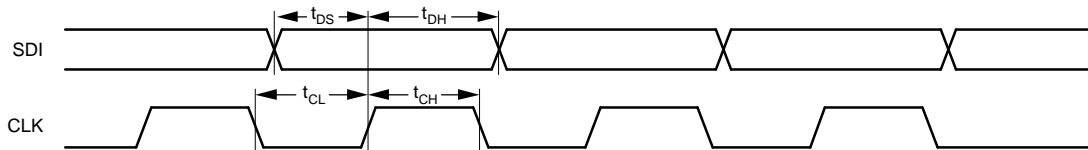

Figure 63. Data and Clock Timing

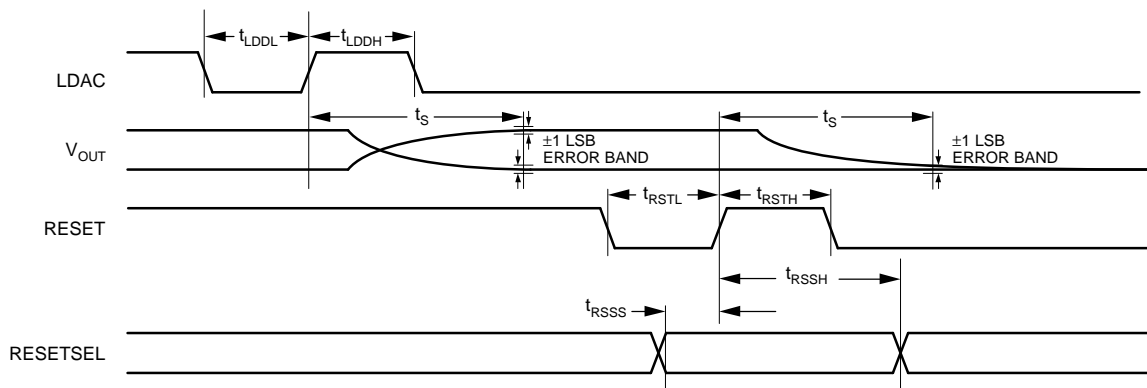

Figure 64. Reset and Output Timing

Table 3. Timing Specifications ($T_A = -40^\circ\text{C}$ to 85°C)

SYMBOL	DESCRIPTION	MIN	UNITS
t_{DS}	Data Valid to CLK Rising	10	ns
t_{DH}	Data Held Valid after CLK Rises	20	ns
t_{CH}	CLK HIGH	25	ns
t_{CL}	CLK LOW	25	ns
t_{CSS}	\overline{CS} LOW to CLK Rising	15	ns
t_{CSH}	CLK HIGH to \overline{CS} Rising	0	ns
t_{LD1}	\overline{LOAD} HIGH to CLK Rising	10	ns
t_{LD2}	CLK Rising to \overline{LOAD} LOW	30	ns
t_{LDRW}	\overline{LOAD} LOW Time	30	ns
t_{LDDL}	LDAC LOW Time	100	ns
t_{LDDH}	LDAC HIGH Time	150	ns
t_{LDDD}	LDAC Rising from \overline{LOAD} LOW	40	ns
t_{RSSS}	RESETSEL Valid to RESET HIGH	0	ns
t_{RSSH}	RESET HIGH to RESETSEL Not Valid	100	ns
t_{RSTL}	RESET LOW Time	10	ns
t_{RSTH}	RESET HIGH Time	10	ns
t_s	Settling Time	10	μs

Figure 65 shows a DAC7634 in a 4-mA to 20-mA current output configuration. The output current can be determined by Equation 3:

$$I_{OUT} = \left[\left(\frac{2.5\text{ V} - 0.5\text{ V}}{125\ \Omega} \right) \times \left(\frac{N}{65,536} \right) \right] + \left(\frac{0.5\text{ V}}{125\ \Omega} \right) \quad (3)$$

At full-scale, the output current is 16 mA, plus the 4 mA, for the zero current. At zero scale, the output current is the offset current of 4 mA ($0.5\text{ V}/125\ \Omega$).

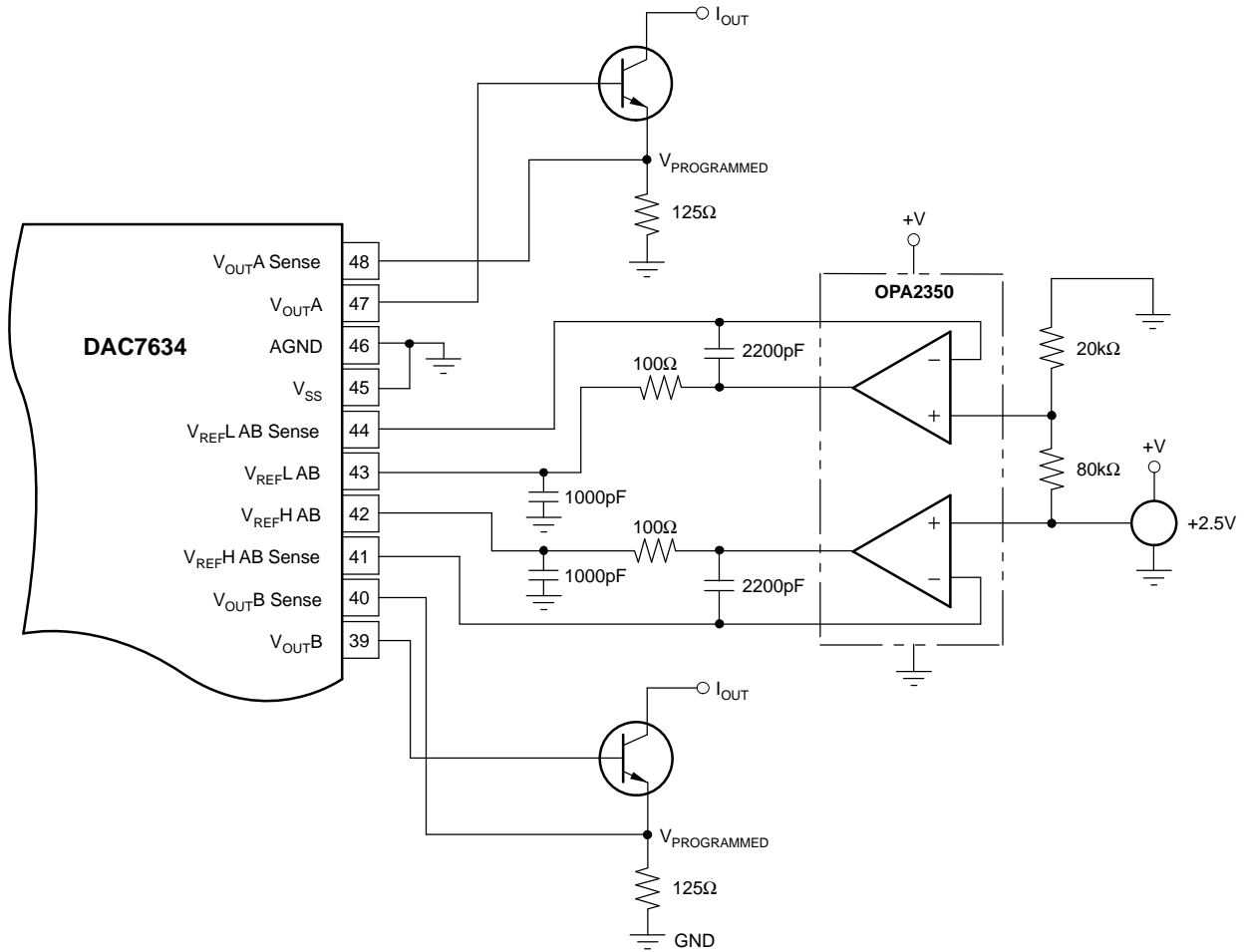

Figure 65. 4 mA to 20 mA Digitally Controlled Current Source (1/2 DAC7634)

PACKAGING INFORMATION

Orderable Device	Status ⁽¹⁾	Package Type	Package Drawing	Pins	Package Qty	Eco Plan ⁽²⁾	Lead/Ball Finish	MSL Peak Temp ⁽³⁾
DAC7634E	ACTIVE	SSOP	DL	48	25	Green (RoHS & no Sb/Br)	CU NIPDAU	Level-3-260C-168 HR
DAC7634E/1K	ACTIVE	SSOP	DL	48	1000	Green (RoHS & no Sb/Br)	CU NIPDAU	Level-3-260C-168 HR
DAC7634E/1KG4	ACTIVE	SSOP	DL	48	1000	Green (RoHS & no Sb/Br)	CU NIPDAU	Level-3-260C-168 HR
DAC7634EB	ACTIVE	SSOP	DL	48	25	Green (RoHS & no Sb/Br)	CU NIPDAU	Level-3-260C-168 HR
DAC7634EB/1K	ACTIVE	SSOP	DL	48	1000	Green (RoHS & no Sb/Br)	CU NIPDAU	Level-3-260C-168 HR
DAC7634EB/1KG4	ACTIVE	SSOP	DL	48	1000	Green (RoHS & no Sb/Br)	CU NIPDAU	Level-3-260C-168 HR
DAC7634EBG4	ACTIVE	SSOP	DL	48	25	Green (RoHS & no Sb/Br)	CU NIPDAU	Level-3-260C-168 HR
DAC7634EG4	ACTIVE	SSOP	DL	48	25	Green (RoHS & no Sb/Br)	CU NIPDAU	Level-3-260C-168 HR

⁽¹⁾ The marketing status values are defined as follows:

ACTIVE: Product device recommended for new designs.

LIFEBUY: TI has announced that the device will be discontinued, and a lifetime-buy period is in effect.

NRND: Not recommended for new designs. Device is in production to support existing customers, but TI does not recommend using this part in a new design.

PREVIEW: Device has been announced but is not in production. Samples may or may not be available.

OBSOLETE: TI has discontinued the production of the device.

⁽²⁾ Eco Plan - The planned eco-friendly classification: Pb-Free (RoHS), Pb-Free (RoHS Exempt), or Green (RoHS & no Sb/Br) - please check <http://www.ti.com/productcontent> for the latest availability information and additional product content details.

TBD: The Pb-Free/Green conversion plan has not been defined.

Pb-Free (RoHS): TI's terms "Lead-Free" or "Pb-Free" mean semiconductor products that are compatible with the current RoHS requirements for all 6 substances, including the requirement that lead not exceed 0.1% by weight in homogeneous materials. Where designed to be soldered at high temperatures, TI Pb-Free products are suitable for use in specified lead-free processes.

Pb-Free (RoHS Exempt): This component has a RoHS exemption for either 1) lead-based flip-chip solder bumps used between the die and package, or 2) lead-based die adhesive used between the die and leadframe. The component is otherwise considered Pb-Free (RoHS compatible) as defined above.

Green (RoHS & no Sb/Br): TI defines "Green" to mean Pb-Free (RoHS compatible), and free of Bromine (Br) and Antimony (Sb) based flame retardants (Br or Sb do not exceed 0.1% by weight in homogeneous material)

⁽³⁾ MSL, Peak Temp. -- The Moisture Sensitivity Level rating according to the JEDEC industry standard classifications, and peak solder temperature.

Important Information and Disclaimer:The information provided on this page represents TI's knowledge and belief as of the date that it is provided. TI bases its knowledge and belief on information provided by third parties, and makes no representation or warranty as to the accuracy of such information. Efforts are underway to better integrate information from third parties. TI has taken and continues to take reasonable steps to provide representative and accurate information but may not have conducted destructive testing or chemical analysis on incoming materials and chemicals. TI and TI suppliers consider certain information to be proprietary, and thus CAS numbers and other limited information may not be available for release.

In no event shall TI's liability arising out of such information exceed the total purchase price of the TI part(s) at issue in this document sold by TI to Customer on an annual basis.

TAPE AND REEL INFORMATION



QUADRANT ASSIGNMENTS FOR PIN 1 ORIENTATION IN TAPE



*All dimensions are nominal

Device	Package Type	Package Drawing	Pins	SPQ	Reel Diameter (mm)	Reel Width W1 (mm)	A0 (mm)	B0 (mm)	K0 (mm)	P1 (mm)	W (mm)	Pin1 Quadrant
DAC7634E/1K	SSOP	DL	48	1000	330.0	32.4	11.35	16.2	3.1	16.0	32.0	Q1
DAC7634EB/1K	SSOP	DL	48	1000	330.0	32.4	11.35	16.2	3.1	16.0	32.0	Q1

TAPE AND REEL BOX DIMENSIONS



*All dimensions are nominal

Device	Package Type	Package Drawing	Pins	SPQ	Length (mm)	Width (mm)	Height (mm)
DAC7634E/1K	SSOP	DL	48	1000	346.0	346.0	49.0
DAC7634EB/1K	SSOP	DL	48	1000	346.0	346.0	49.0

DL (R-PDSO-G**)

PLASTIC SMALL-OUTLINE PACKAGE

48 PINS SHOWN

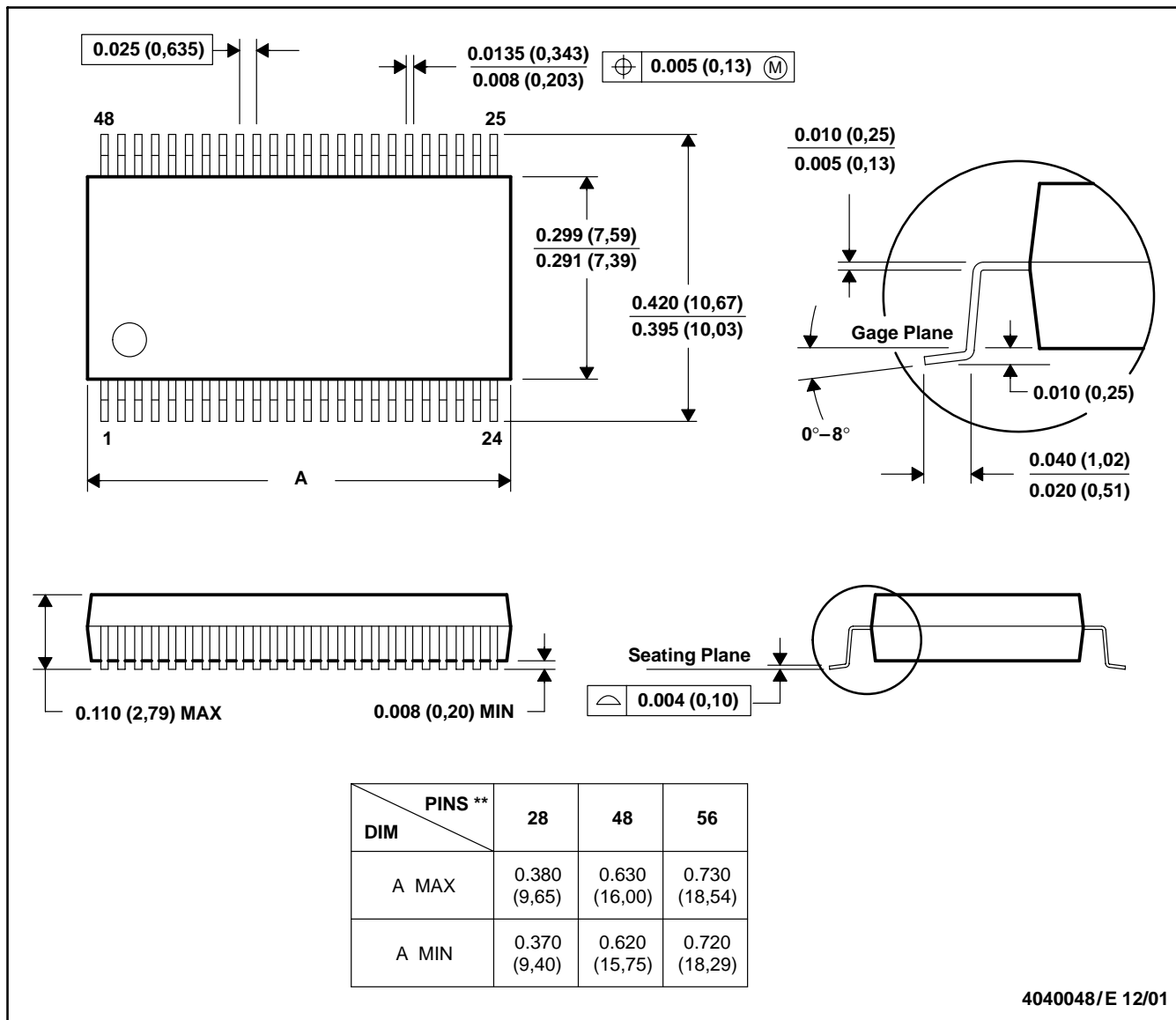

- NOTES: A. All linear dimensions are in inches (millimeters).
 B. This drawing is subject to change without notice.
 C. Body dimensions do not include mold flash or protrusion not to exceed 0.006 (0,15).
 D. Falls within JEDEC MO-118

IMPORTANT NOTICE

Texas Instruments Incorporated and its subsidiaries (TI) reserve the right to make corrections, modifications, enhancements, improvements, and other changes to its products and services at any time and to discontinue any product or service without notice. Customers should obtain the latest relevant information before placing orders and should verify that such information is current and complete. All products are sold subject to TI's terms and conditions of sale supplied at the time of order acknowledgment.

TI warrants performance of its hardware products to the specifications applicable at the time of sale in accordance with TI's standard warranty. Testing and other quality control techniques are used to the extent TI deems necessary to support this warranty. Except where mandated by government requirements, testing of all parameters of each product is not necessarily performed.

TI assumes no liability for applications assistance or customer product design. Customers are responsible for their products and applications using TI components. To minimize the risks associated with customer products and applications, customers should provide adequate design and operating safeguards.

TI does not warrant or represent that any license, either express or implied, is granted under any TI patent right, copyright, mask work right, or other TI intellectual property right relating to any combination, machine, or process in which TI products or services are used. Information published by TI regarding third-party products or services does not constitute a license from TI to use such products or services or a warranty or endorsement thereof. Use of such information may require a license from a third party under the patents or other intellectual property of the third party, or a license from TI under the patents or other intellectual property of TI.

Reproduction of TI information in TI data books or data sheets is permissible only if reproduction is without alteration and is accompanied by all associated warranties, conditions, limitations, and notices. Reproduction of this information with alteration is an unfair and deceptive business practice. TI is not responsible or liable for such altered documentation. Information of third parties may be subject to additional restrictions.

Resale of TI products or services with statements different from or beyond the parameters stated by TI for that product or service voids all express and any implied warranties for the associated TI product or service and is an unfair and deceptive business practice. TI is not responsible or liable for any such statements.

TI products are not authorized for use in safety-critical applications (such as life support) where a failure of the TI product would reasonably be expected to cause severe personal injury or death, unless officers of the parties have executed an agreement specifically governing such use. Buyers represent that they have all necessary expertise in the safety and regulatory ramifications of their applications, and acknowledge and agree that they are solely responsible for all legal, regulatory and safety-related requirements concerning their products and any use of TI products in such safety-critical applications, notwithstanding any applications-related information or support that may be provided by TI. Further, Buyers must fully indemnify TI and its representatives against any damages arising out of the use of TI products in such safety-critical applications.

TI products are neither designed nor intended for use in military/aerospace applications or environments unless the TI products are specifically designated by TI as military-grade or "enhanced plastic." Only products designated by TI as military-grade meet military specifications. Buyers acknowledge and agree that any such use of TI products which TI has not designated as military-grade is solely at the Buyer's risk, and that they are solely responsible for compliance with all legal and regulatory requirements in connection with such use.

TI products are neither designed nor intended for use in automotive applications or environments unless the specific TI products are designated by TI as compliant with ISO/TS 16949 requirements. Buyers acknowledge and agree that, if they use any non-designated products in automotive applications, TI will not be responsible for any failure to meet such requirements.

Following are URLs where you can obtain information on other Texas Instruments products and application solutions:

Products

Amplifiers	amplifier.ti.com
Data Converters	dataconverter.ti.com
DSP	dsp.ti.com
Clocks and Timers	www.ti.com/clocks
Interface	interface.ti.com
Logic	logic.ti.com
Power Mgmt	power.ti.com
Microcontrollers	microcontroller.ti.com
RFID	www.ti-rfid.com
RF/IF and ZigBee® Solutions	www.ti.com/lprf

Applications

Audio	www.ti.com/audio
Automotive	www.ti.com/automotive
Broadband	www.ti.com/broadband
Digital Control	www.ti.com/digitalcontrol
Medical	www.ti.com/medical
Military	www.ti.com/military
Optical Networking	www.ti.com/opticalnetwork
Security	www.ti.com/security
Telephony	www.ti.com/telephony
Video & Imaging	www.ti.com/video
Wireless	www.ti.com/wireless

Mailing Address: Texas Instruments, Post Office Box 655303, Dallas, Texas 75265
Copyright © 2008, Texas Instruments Incorporated