

SPECIFICATION

Part No. : **GW26.0152**

Product Name : 2.4GHz Miniature Screw mount Monopole
Antenna

Feature : RP-SMA(M)
Fixed 90°
ROHS Compliant



1 Introduction

The GW.26 2.4 GHz Monopole RP-SMA(M) antenna is ideal for 2.4 GHz wireless applications such as Bluetooth and Wireless LAN. Connector mount is fully customizable.

2 Specification

GPS	
Frequency	2400~2500MHz
Bandwidth	1000MHz
Peak Gain	> 0dBi
Radiation Efficiency	> 40%
Radiation	Omni-directional
Polarization	Vertical
Power Handling 1W Max	Power Handling 1W Max
Electrical Wave	Monopole
Impedance	50Ω
Operating Temperature	-40°C ~ +85°C
Storage Temperature	-40°C ~ +85°C

3 Mechanical Properties

Mechanical Properties	
Colour	Black and Green
Connector	RP-SMA(M) R/A

4 Antenna Characteristics

4.1 Antenna S11

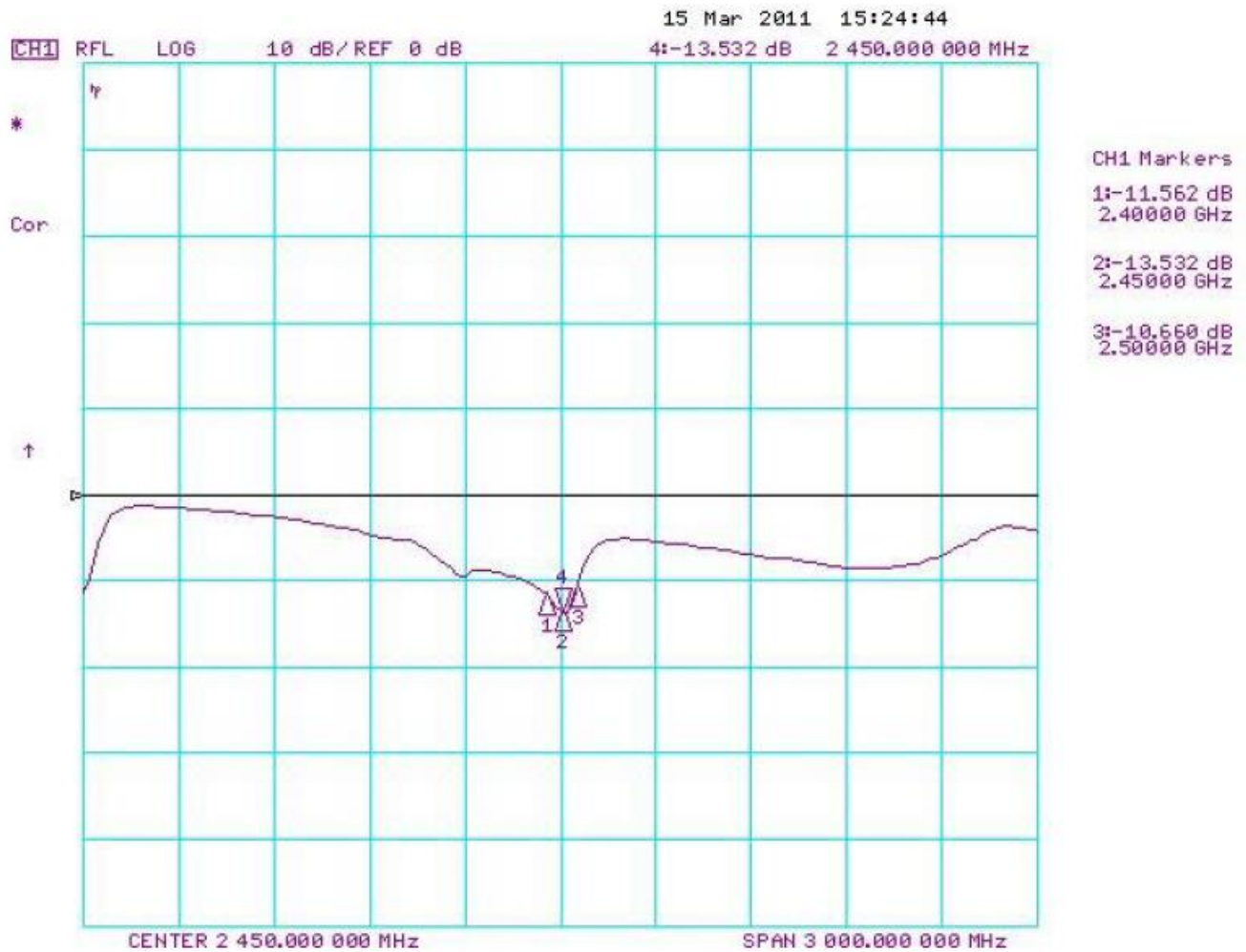

4.2 Antenna Peak Gain

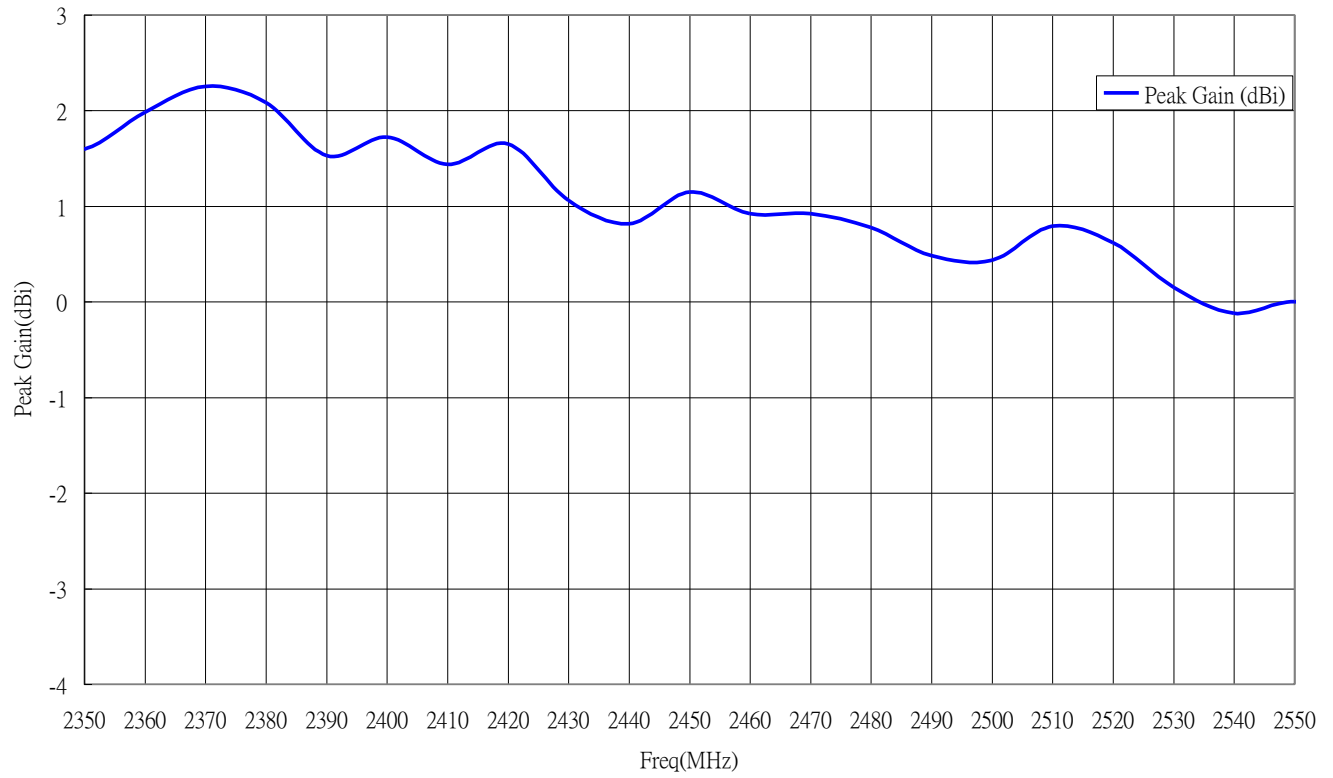

4.3 Antenna Efficiency

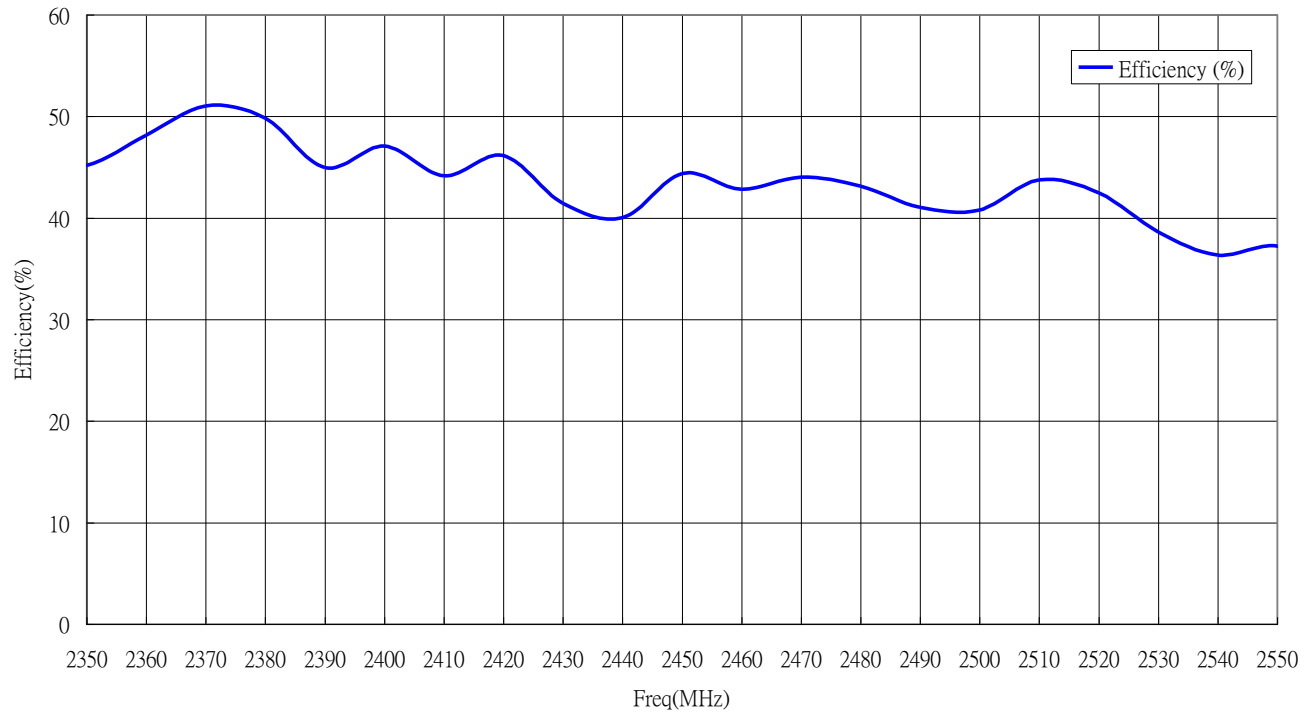

4.4 Antenna pattern (XY plane)

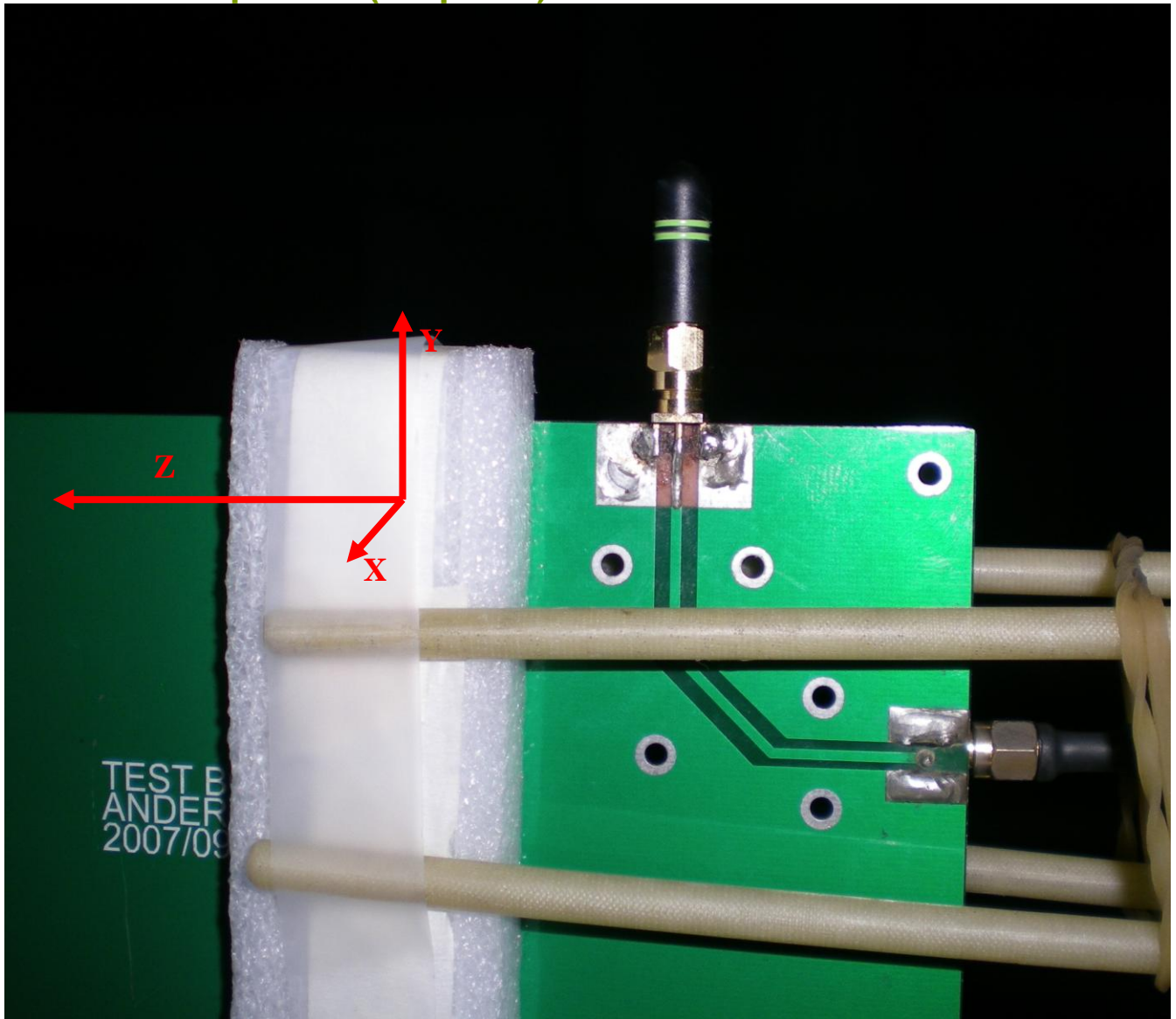

4.5 Antenna pattern (XY plane)

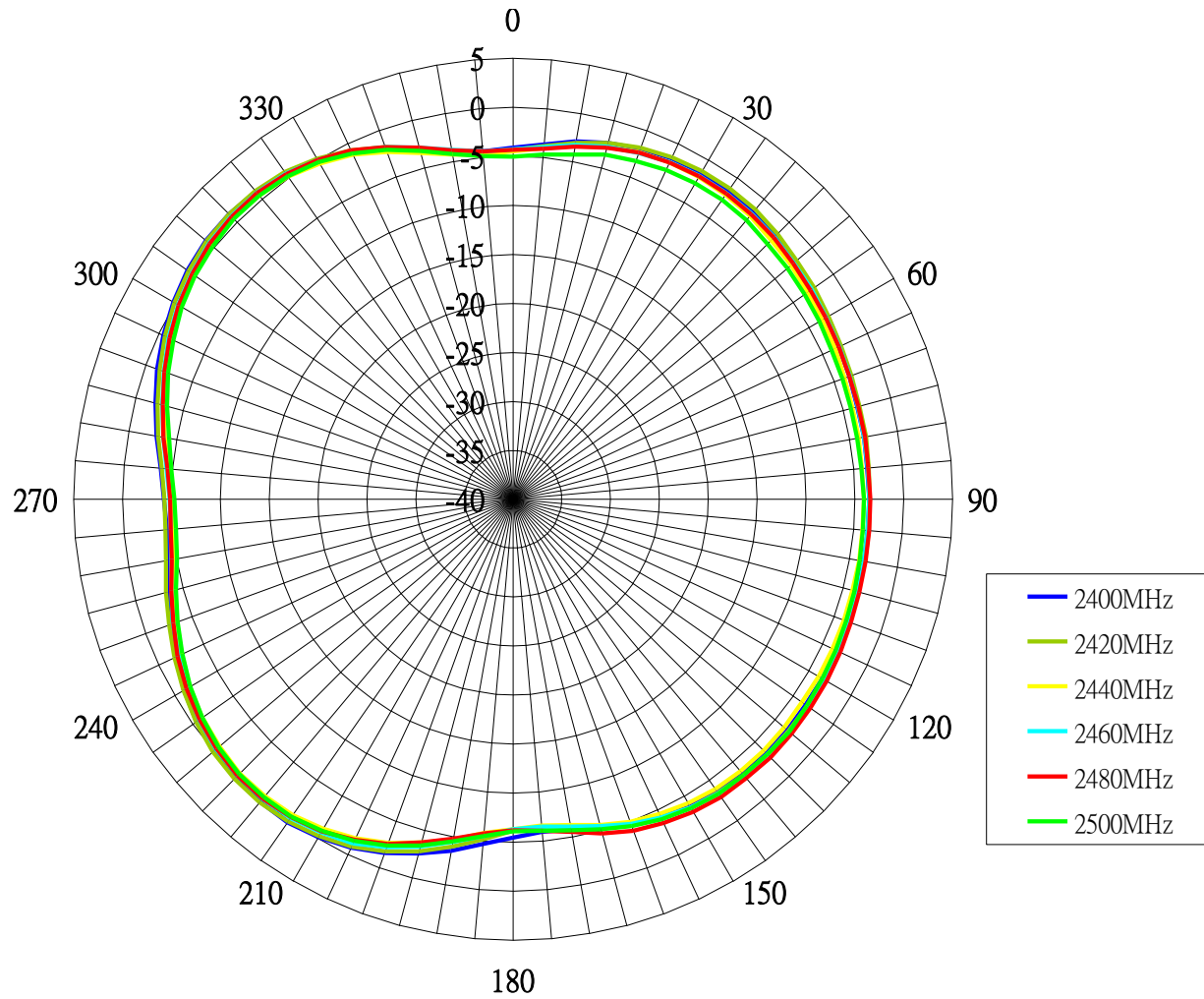

4.6 Antenna pattern (XZ plane)

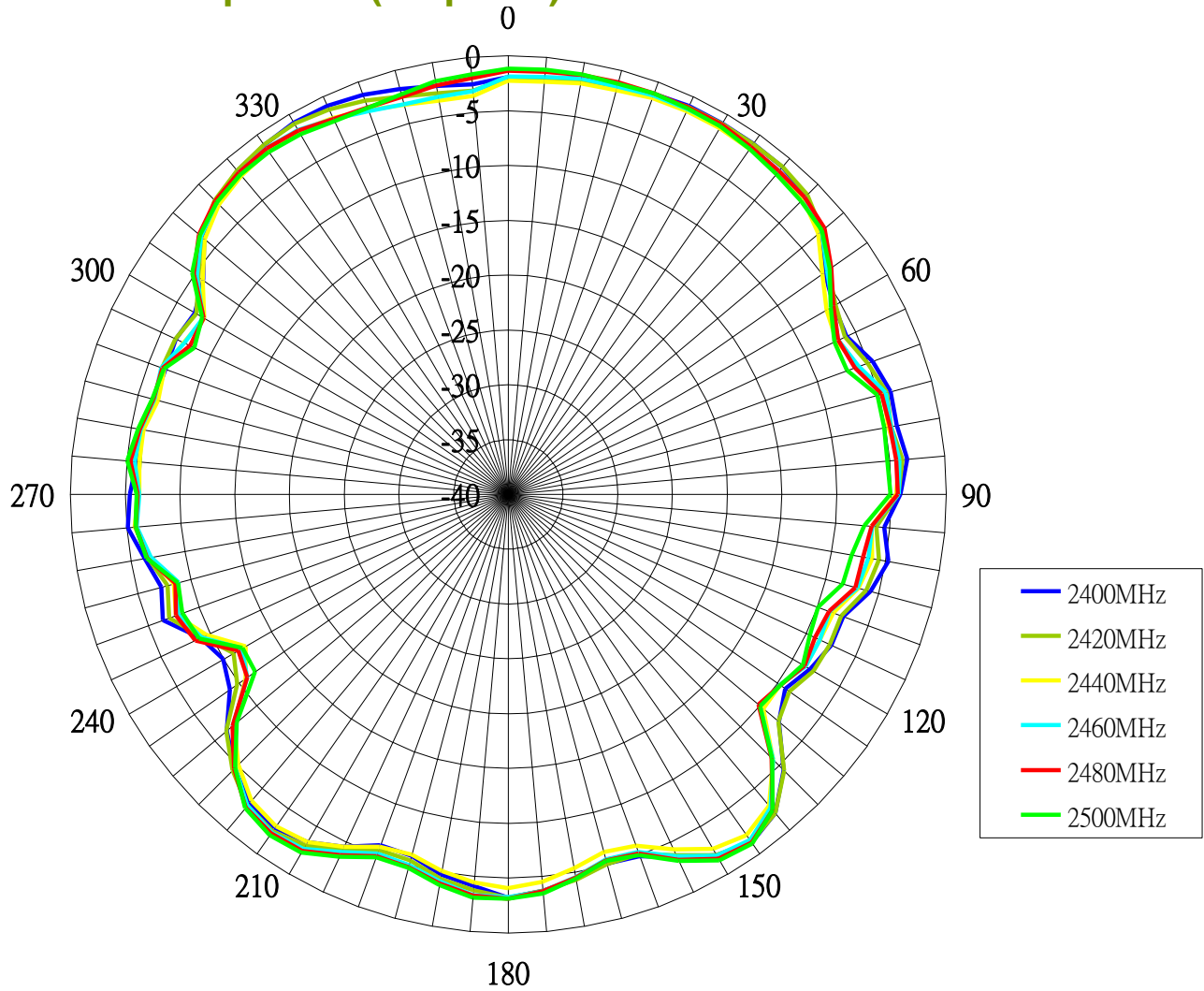

4.7 Antenna pattern (YZ plane)

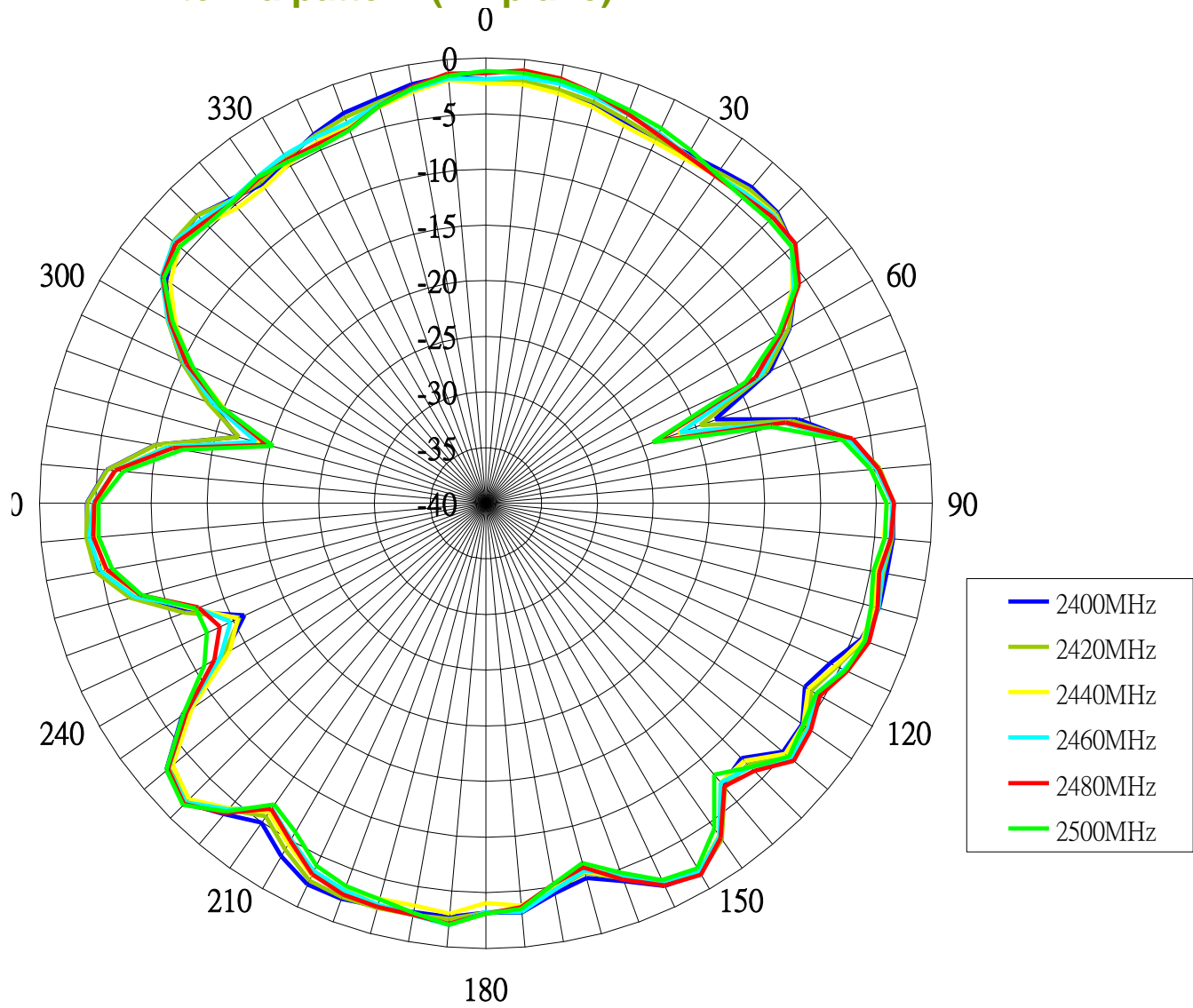

5. Outline Drawings and Structure

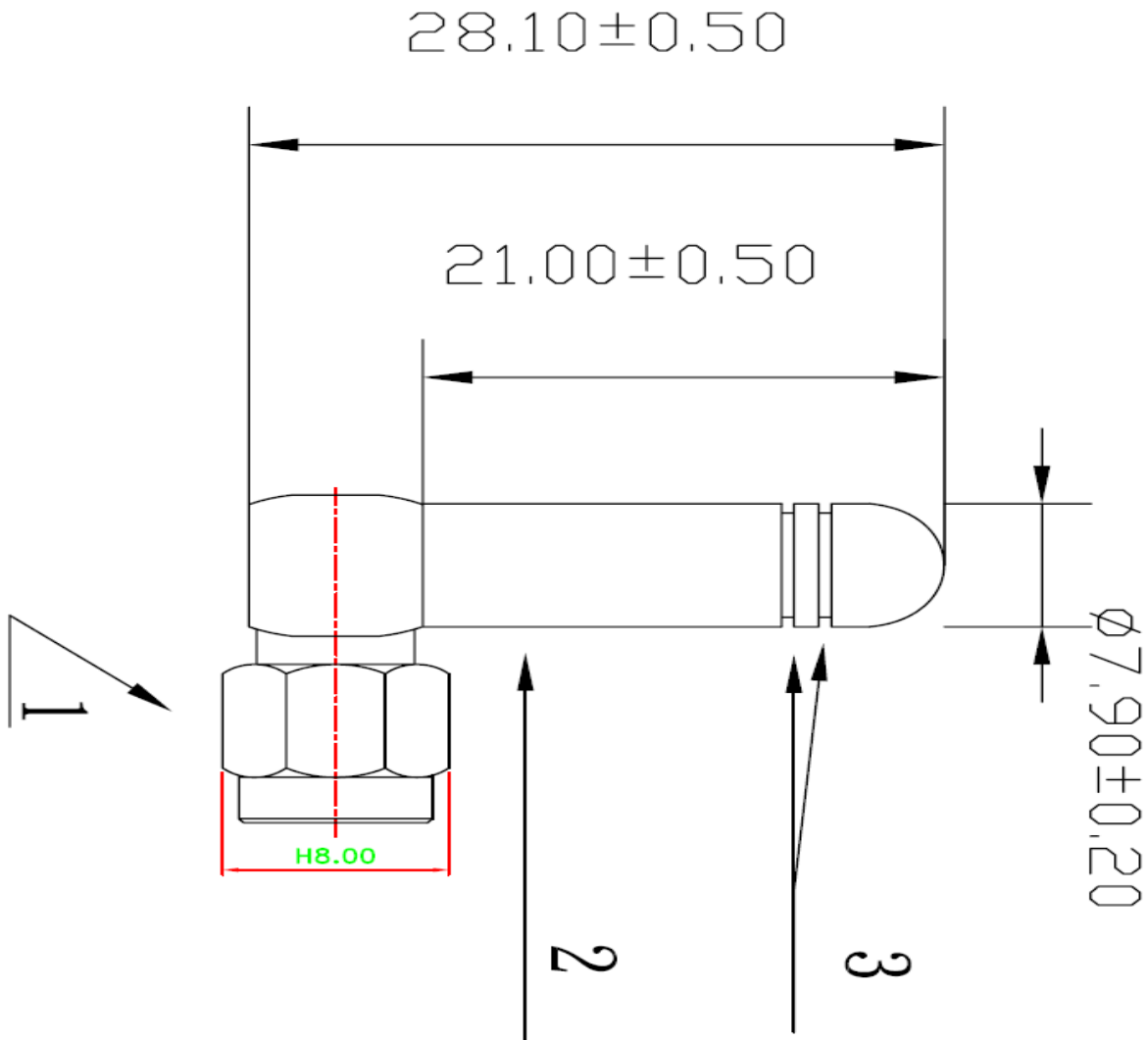

Key

1	Connector	RP-SMA(M)
2	Antenna Cover	TPU(Black)
3	Colour Stripes	Apple Green