

## SPECIFICATION

Part No. : **GW26.01.0112**

Product Name : 2.4GHz Miniature Screw mount Monopole  
Antenna

Feature : SMA(M)R/A Connector  
ROHS Compliant



## 1 Introduction

The GW.26 2.4 GHz Monopole SMA(M)R/A mount antenna is ideal for 2.4 GHz wireless applications such as Bluetooth and Wireless LAN. Connector mount is fully customizable.

## 2 Specification

GPS	
Frequency	2400~2500MHz
Bandwidth	1000MHz
Peak Gain	> 0dBi
Radiation Efficiency	> 40%
Radiation	Omni-directional
Polarization	Vertical
Power Handling 1W Max	Power Handling 1W Max
Electrical Wave	½ Monopole
Impedance	50Ω
Operating Temperature	-40°C ~ +85°C
Storage Temperature	-40°C ~ +85°C

## 3 Mechanical Properties

Mechanical Properties	
Colour	Black and Green
Connector	SMA(M) R/A

## 4 Antenna Characteristics

### 4.1 Antenna S11

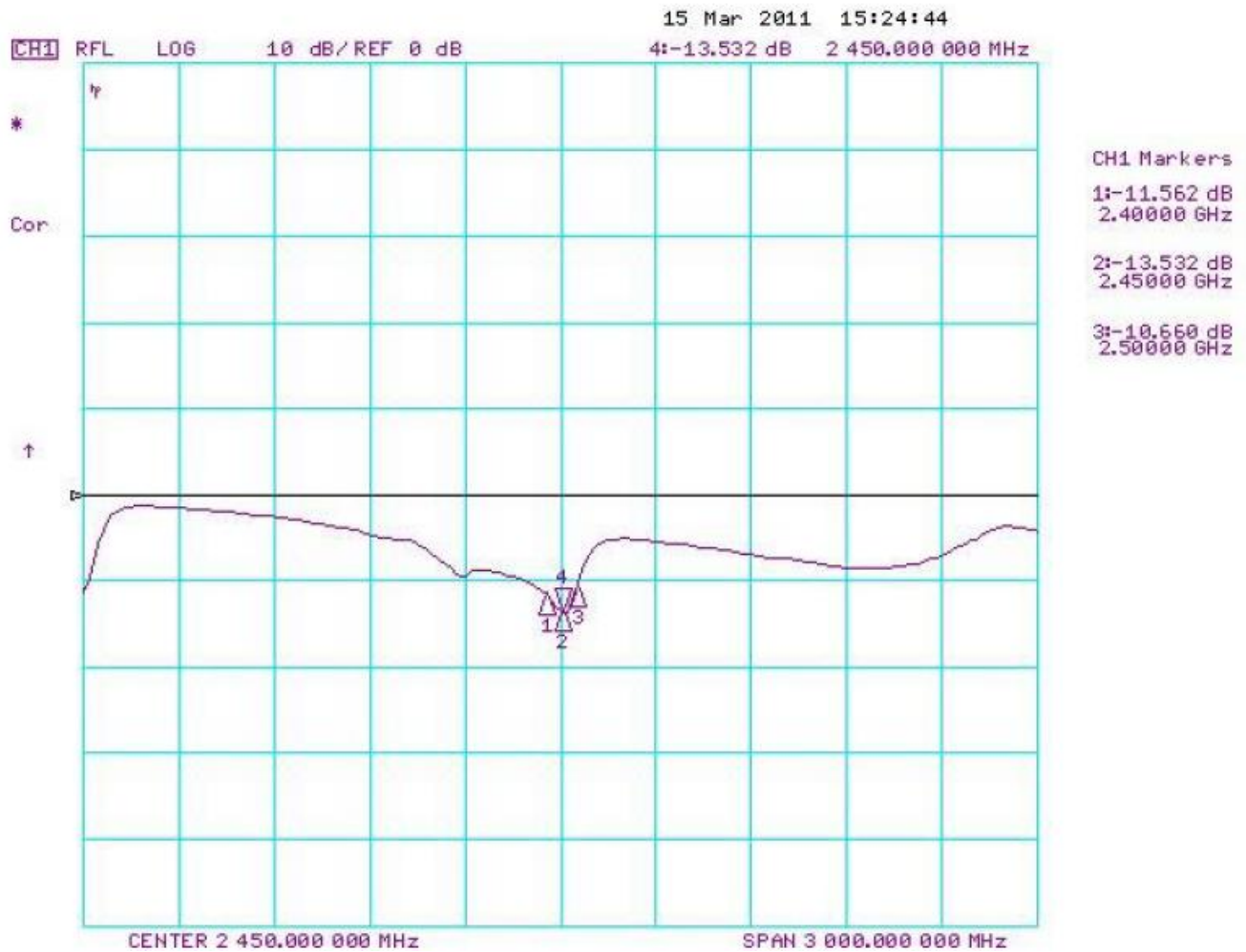

## 4.2 Antenna Peak Gain

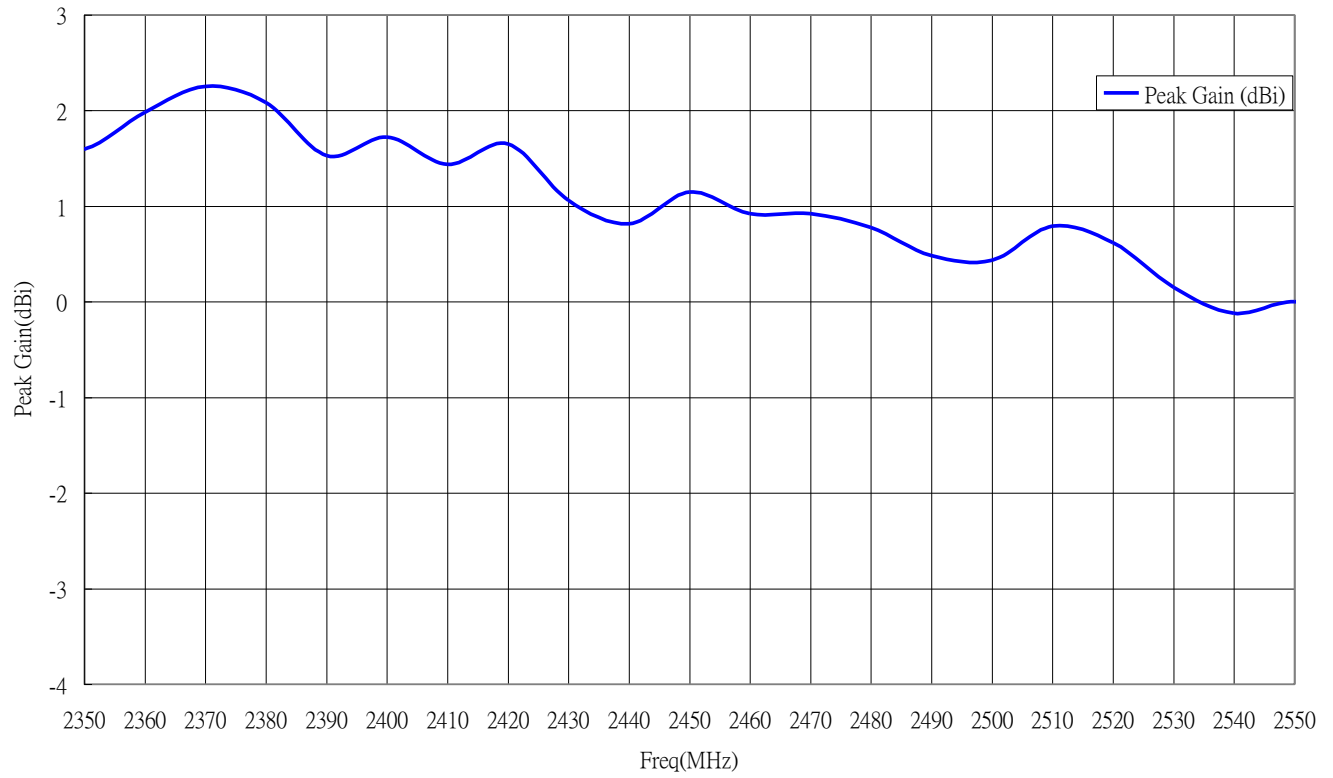

### 4.3 Antenna Efficiency

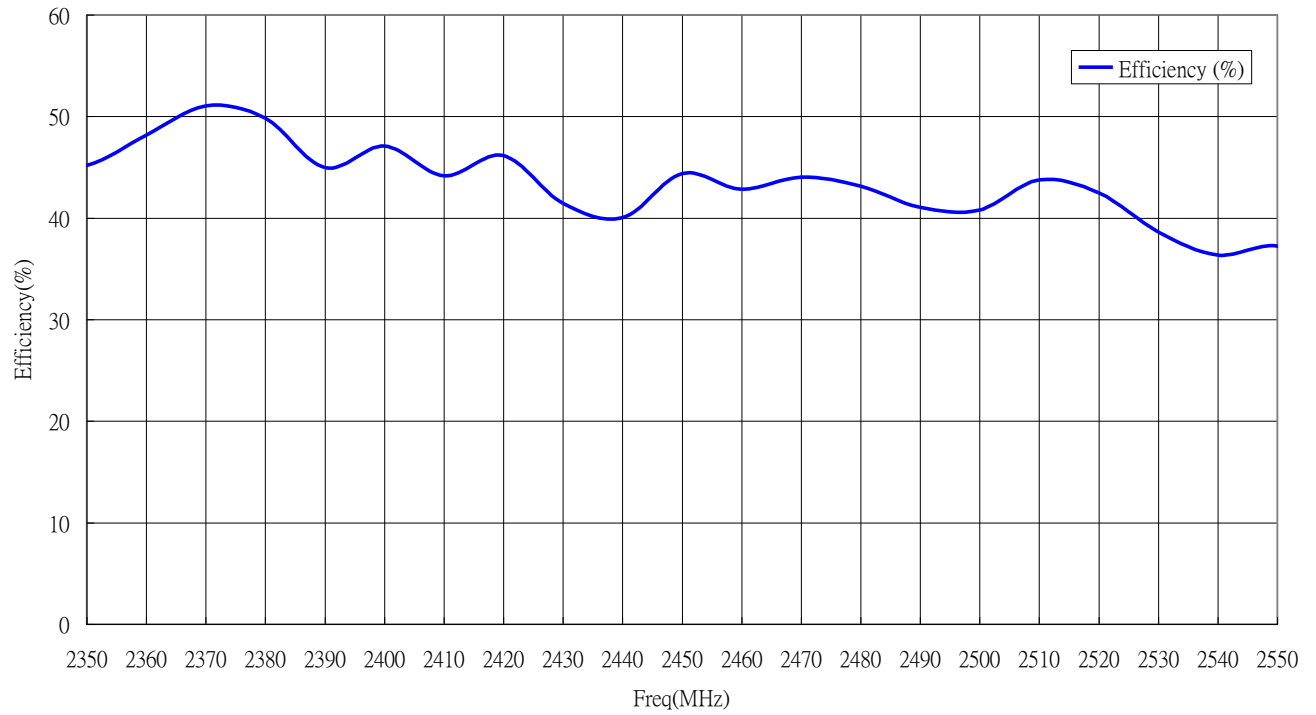

#### 4.4 Antenna pattern (XY plane)

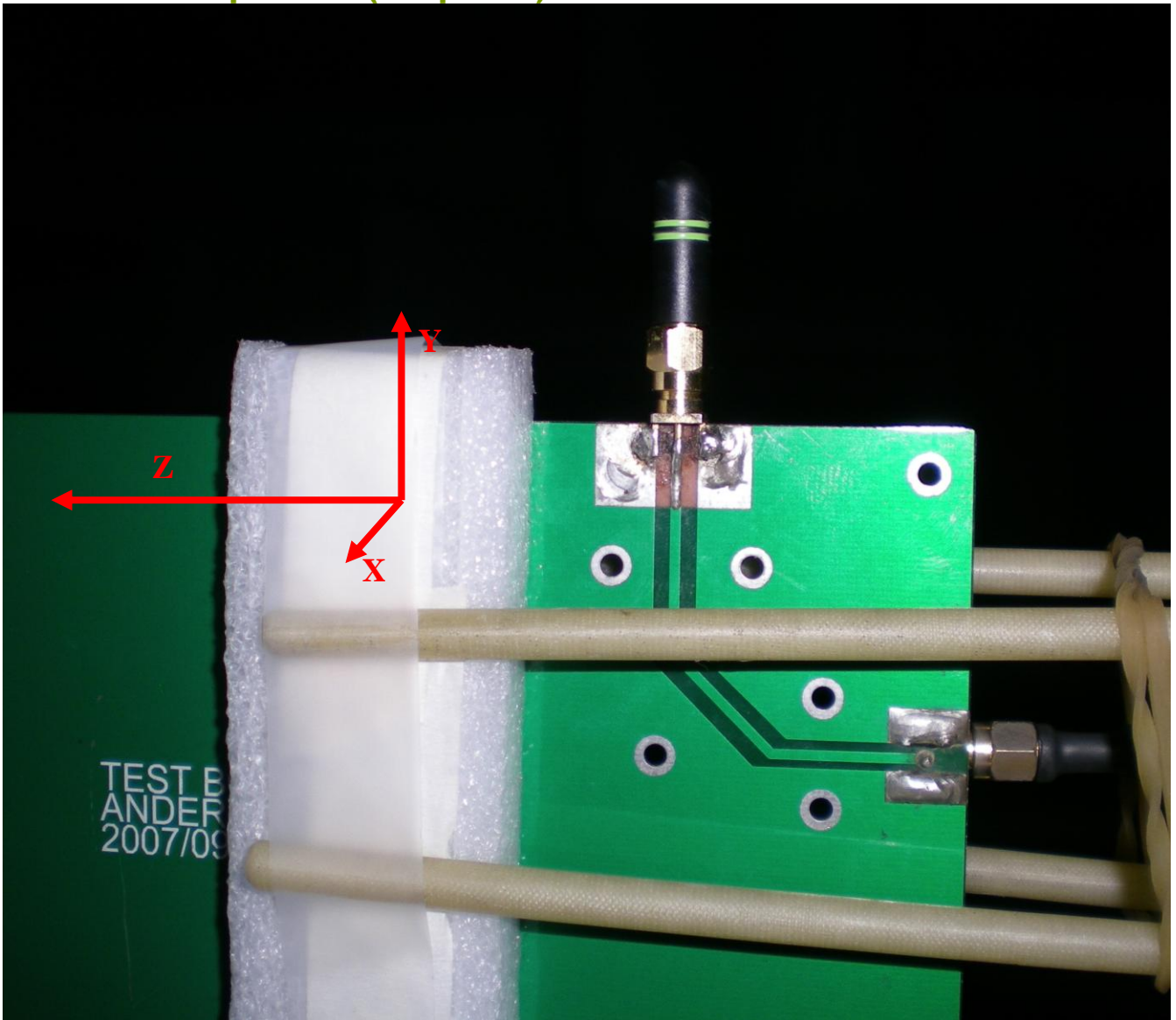

### 4.5 Antenna pattern (XY plane)

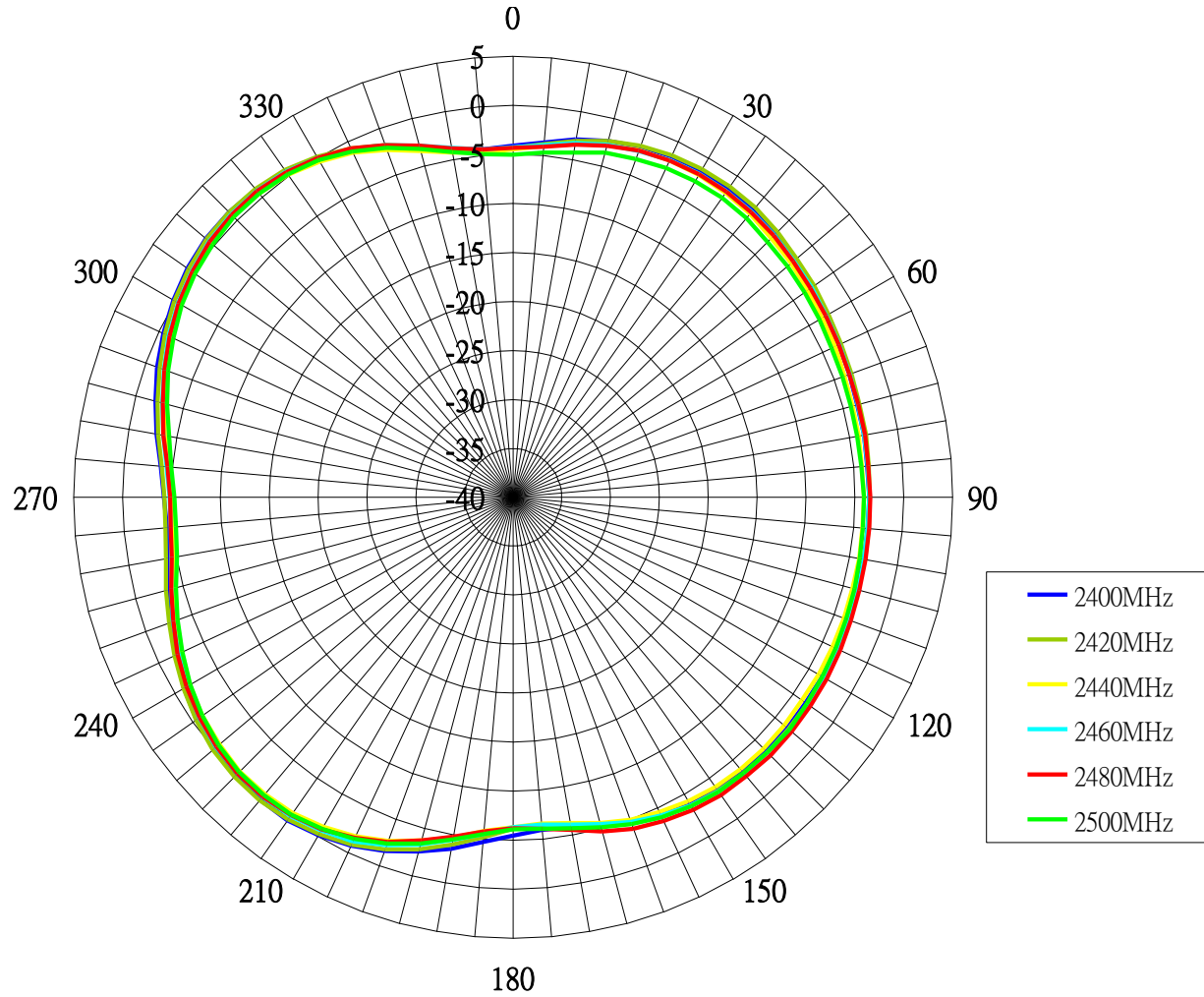

### 4.6 Antenna pattern (XZ plane)

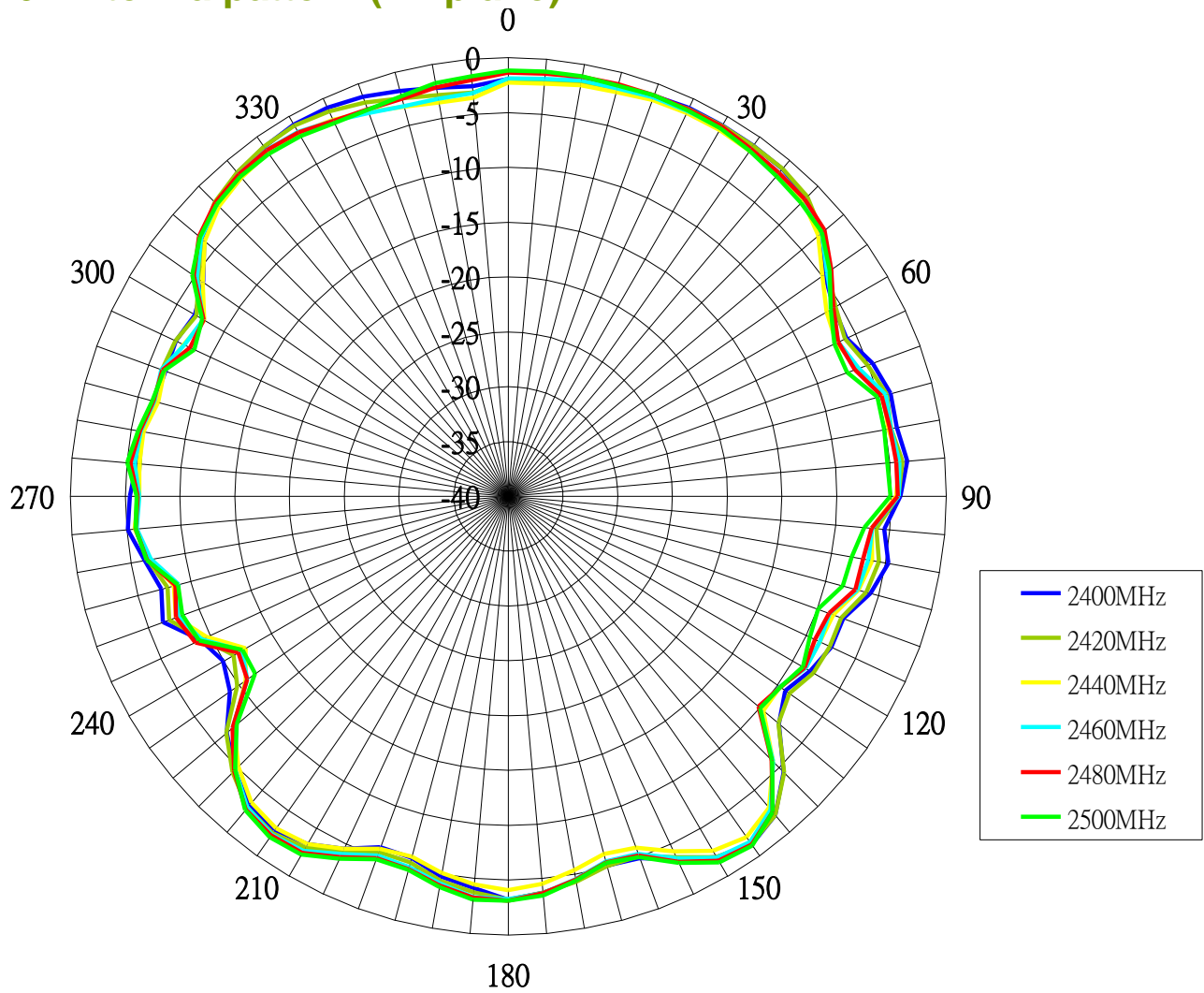



### 4.7 Antenna pattern (YZ plane)

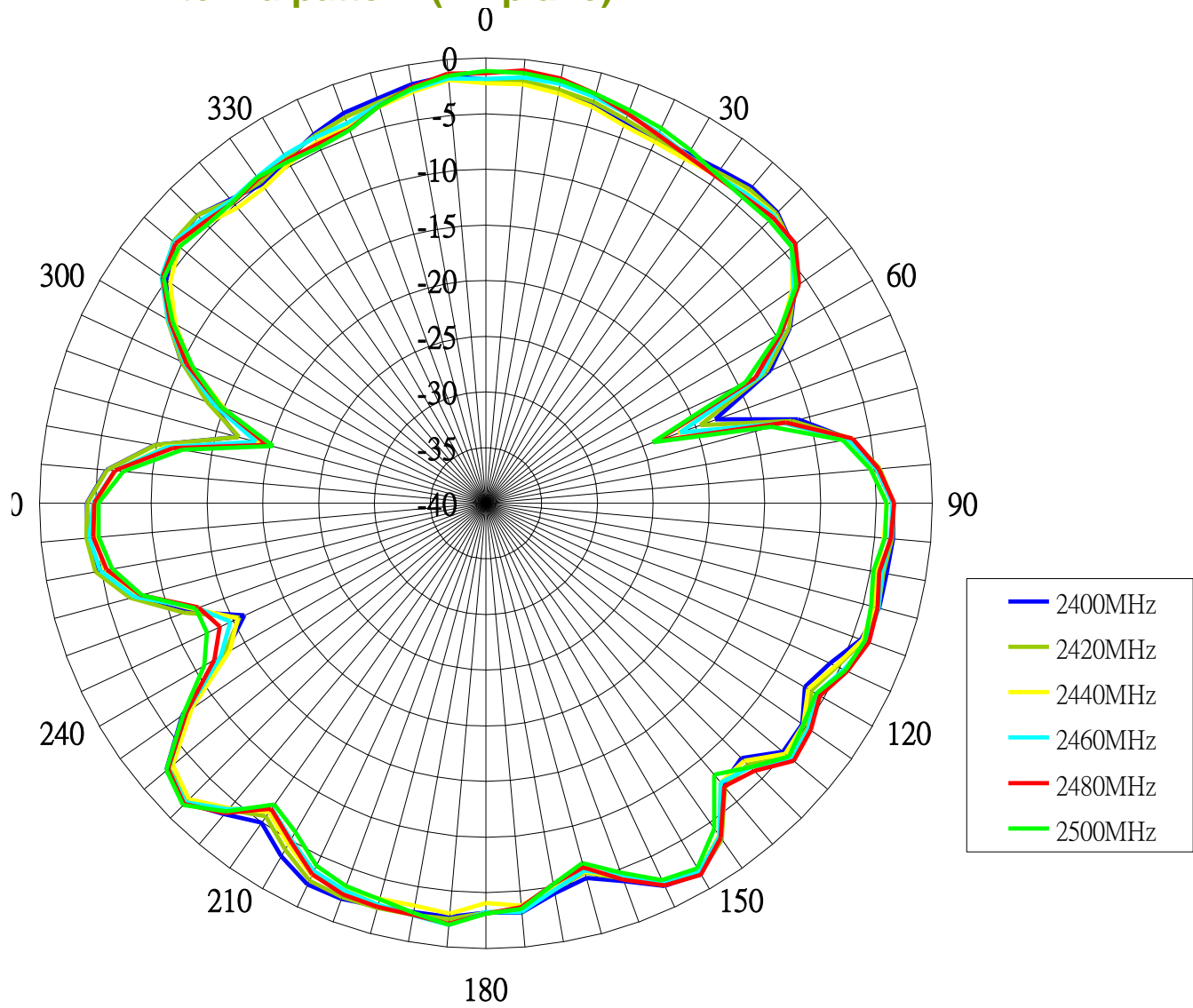

## 5. Outline Drawings and Structure

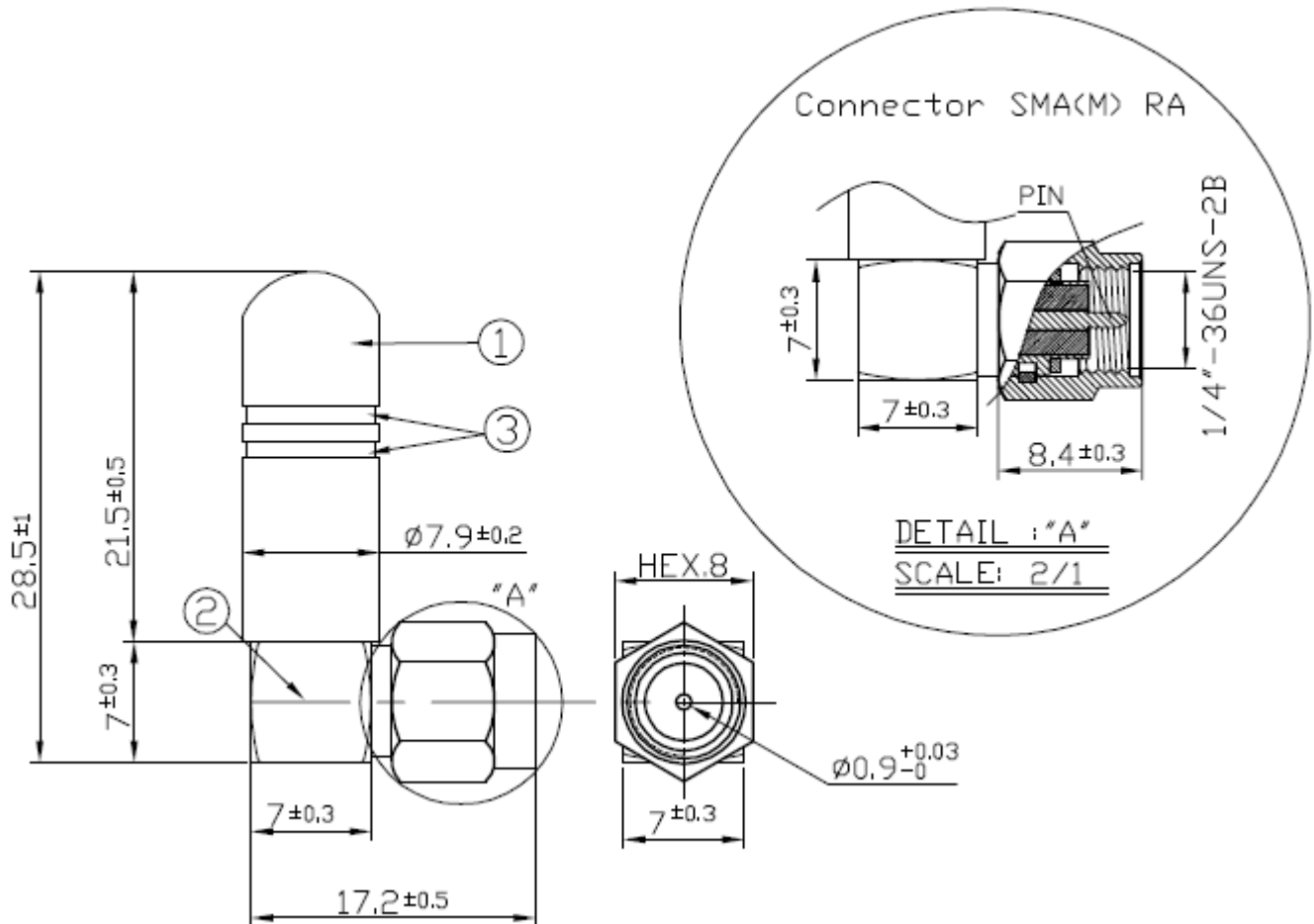

### Key

1	Connector	SMA(M)RA Brass
2	Antenna Cover	TPEE (Black)
3	Colour Stripes	Apple Green – Acrylic Paint